

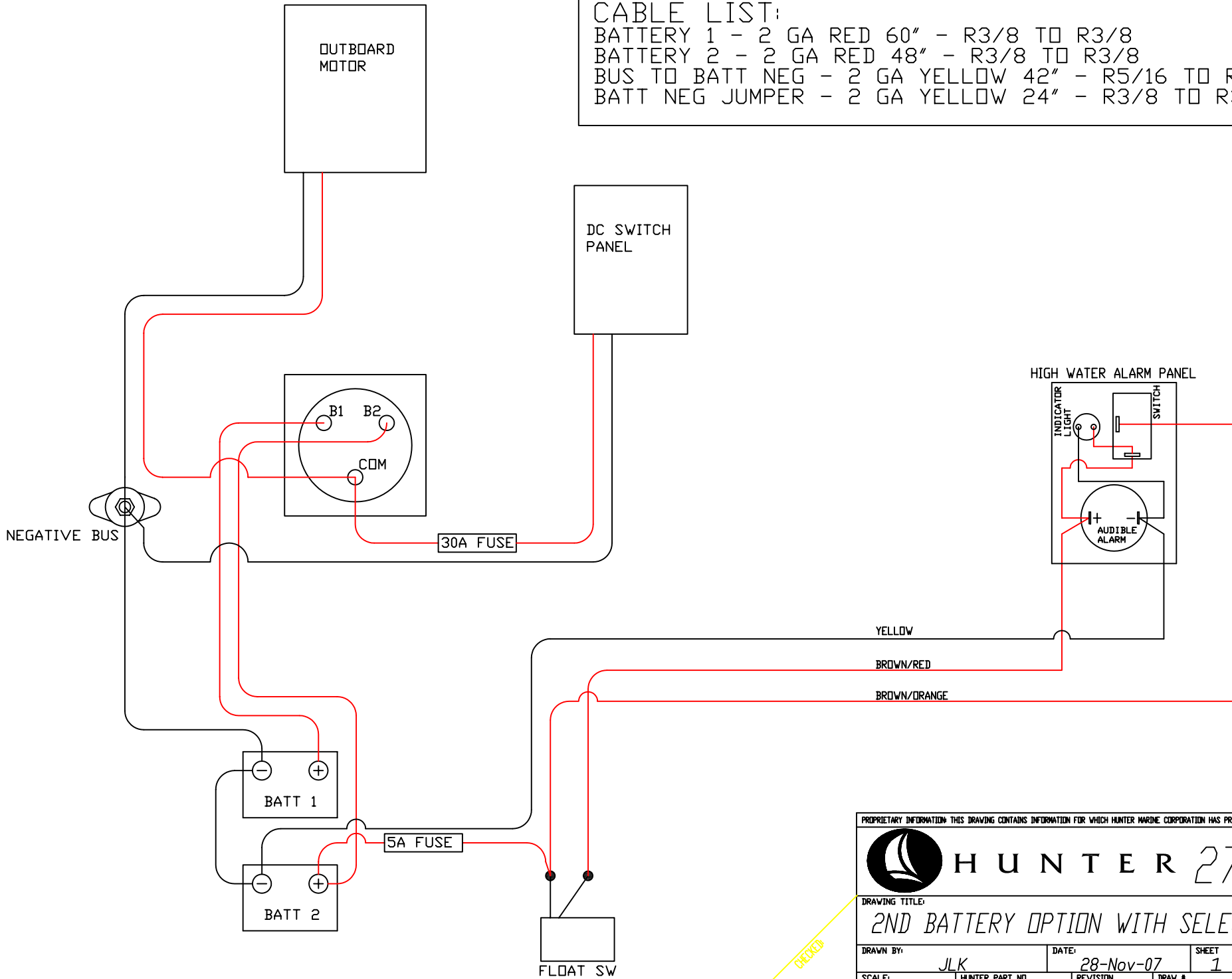

CABLE LIST:

- BATTERY 1 - 2 GA RED 60" - R3/8 TO R3/8
- BATTERY 2 - 2 GA RED 48" - R3/8 TO R3/8
- BUS TO BATT NEG - 2 GA YELLOW 42" - R5/16 TO R3/8
- BATT NEG JUMPER - 2 GA YELLOW 24" - R3/8 TO R3/8



PROPRIETARY INFORMATION THIS DRAWING CONTAINS INFORMATION FOR WHICH HUNTER MARINE CORPORATION HAS PROPRIETARY RIGHTS.



**HUNTER 27PS**

DRAWING TITLE:  
*2ND BATTERY OPTION WITH SELECTOR*

DRAWN BY: <i>JLK</i>	DATE: <i>28-Nov-07</i>	SHEET <i>1</i>	OF <i>1</i>
SCALE: <i>NA</i>	HUNTER PART NO. <i>TBD</i>	REVISION <i>-</i>	DRAW # <i>-----</i>

CHECKED

# BILGE PUMP

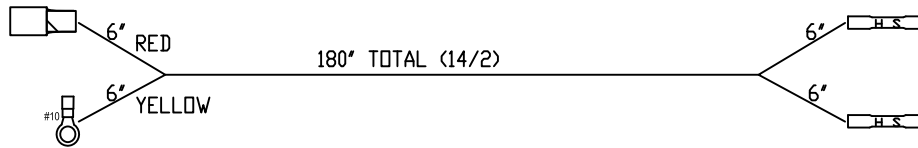

# WATER PUMP

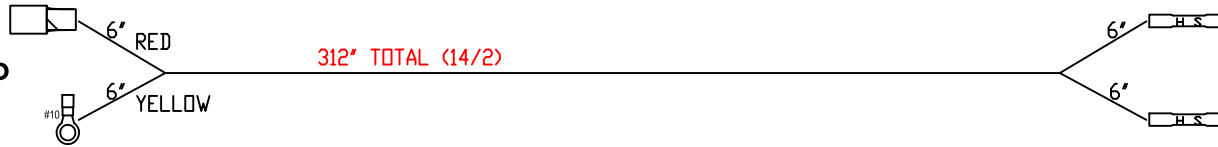

# 12V COOLER

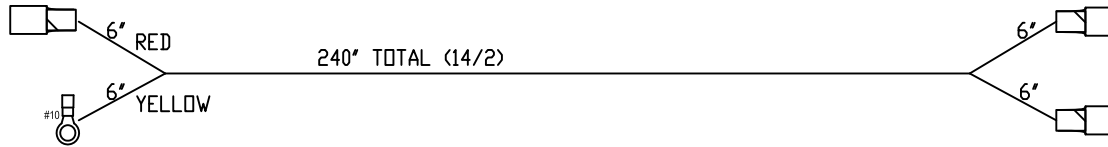

# SHORE POWER

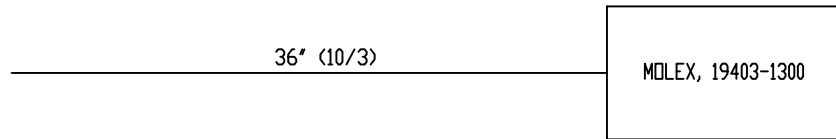

— = CONDUIT

— H.S. — BARREL

#10 RING

1/4" RING

5/16" RING

3/8 RING

1/4 SLIDE

1/4 SLIDE WPIGGYBACK

PROPRIETARY INFORMATION: THIS DRAWING CONTAINS INFORMATION FOR WHICH HUNTER MARINE CORPORATION HAS PROPRIETARY RIGHTS.

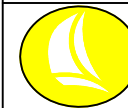

HUNTER 27PS





DRAWING TITLE:

OPTIONAL ELECTRICAL KITS

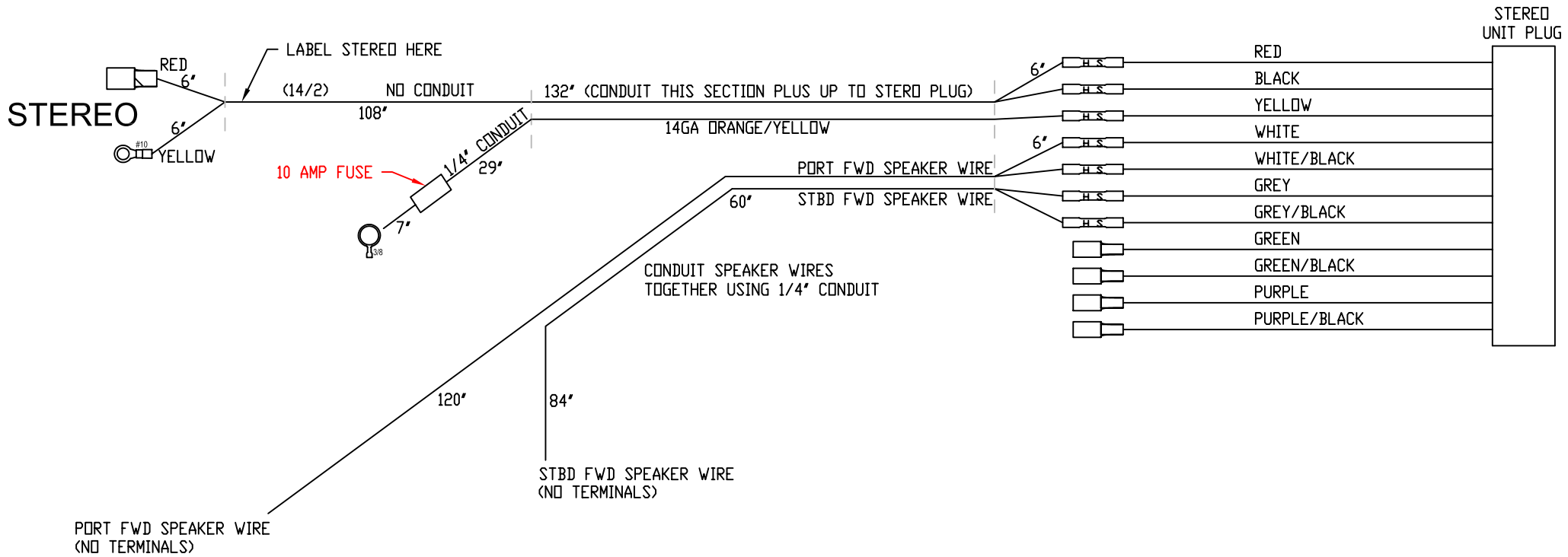
DRAWN BY: *JLK* DATE: *26-AUG-08* SHEET *1* OF *1*

SCALE: *0.045* HUNTER PART NO. *TBD* REVISION *-* DRAW #



-  BARREL
-  #10 RING
-  3/8 RING
-  1/4 SLIDE
-  BULLET, PERMA SEAL  
PN 19164-0052



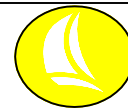



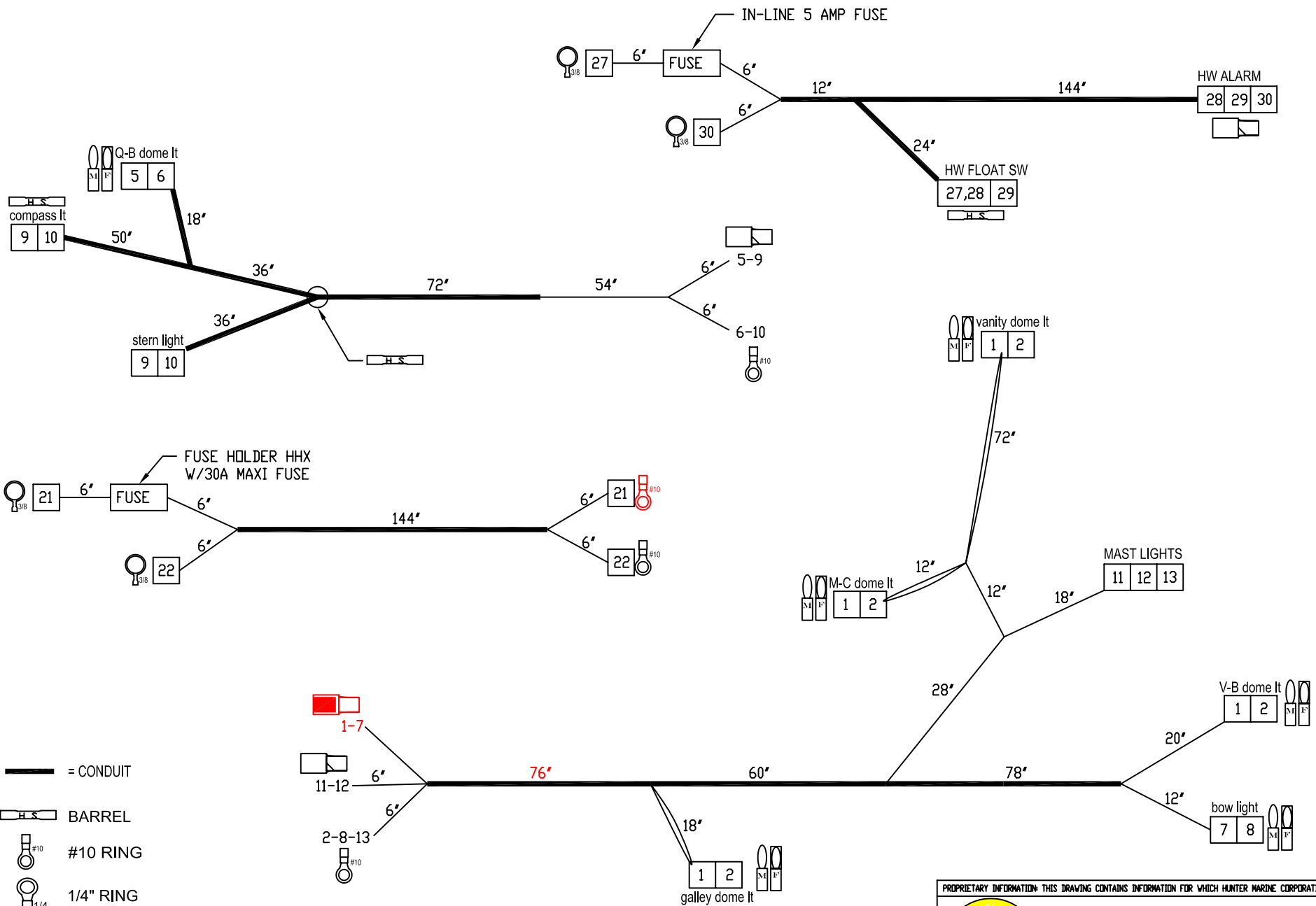

PROPRIETARY INFORMATION: THIS DRAWING CONTAINS INFORMATION FOR WHICH HUNTER MARINE CORPORATION HAS PROPRIETARY RIGHTS.



HUNTER 27PS

DRAWING TITLE: <b>STEREO HARNESS</b>				
DRAWN BY: <i>JLK</i>	DATE: <i>July 27, 2008</i>	SHEET <i>1</i>	OF <i>1</i>	
SCALE:	HUNTER PART NO.	REVISION	DRAW #	



-  = CONDUIT
-  BARREL
-  #10 RING
-  1/4" RING
-  5/16" RING
-  3/8 RING
-  1/4 SLIDE
-  1/4 SLIDE W/PIGGYBACK

 LIGHT CONNECTORS  
 blue wires bullet recept.  
 yellow wires bullet plug

PROPRIETARY INFORMATION: THIS DRAWING CONTAINS INFORMATION FOR WHICH HUNTER MARINE CORPORATION HAS PROPRIETARY RIGHTS.

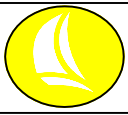

# HUNTER 26PS

DRAWING TITLE: *ELECTRICAL HARNESS*

DRAWN BY: <i>JLK</i>	DATE: <i>3-June-08</i>	SHEET <i>1</i>	OF <i>1</i>
SCALE: <i>0.045</i>	HUNTER PART NO. <i>TBD</i>	REVISION	DRAW #

HUNTER 27PS DC DECK HARNESS				6/3/2008
WIRE#	GAUGE	COLOR	LENGTH	FUNCTION
1	16	BLUE	524	GALLEY&FWD LIGHTS
2	16	YELLOW	524	GALLEY&FWD LIGHTS NEG.
5	16	BLUE	186	AFT CABIN LIGHTS
6	16	YELLOW	186	AFT CABIN LIGHTS NEG.
7	16	GRAY/WHITE	232	BOW LIGHT
8	16	YELLOW	232	BOW LIGHT NEG.
9	16	GRAY/YELLOW	254	STERN LT
10	16	YELLOW	254	STERN LT NEG.
11	16	GRAY/RED	188	ANCHOR LT
12	16	GRAY/GREEN	188	STEAMING LT
13	16	YELLOW	188	MAST LTS NEG.
21	6	ORANGE/RED	144	PANEL POWER
22	6	YELLOW	144	PANEL NEG.
27	16	BROWN/ORG	48	HW ALARM POWER
28	16	BROWN/ORG	168	HW ALARM POWER2
29	16	BROWN/RED	168	HW ALARM INDICATOR
30	16	YELLOW	162	HW ALARM NEG.

MOLEX SC (BLUE)



12' TOTAL (14/3)

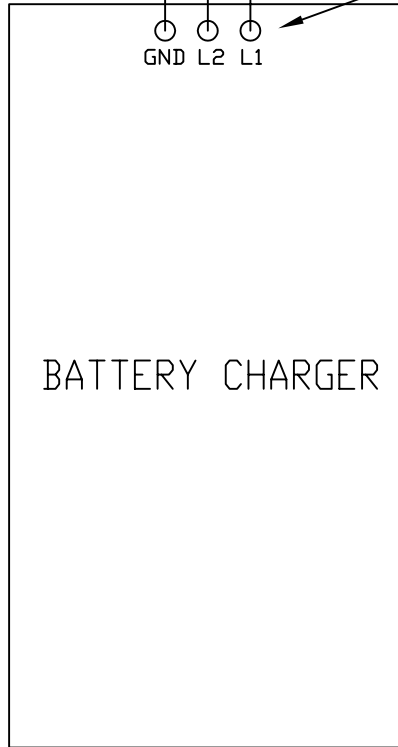
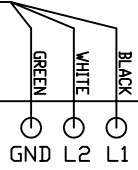

PROPRIETARY INFORMATION THIS DRAWING CONTAINS INFORMATION FOR WHICH HUNTER MARINE CORPORATION HAS PROPRIETARY RIGHTS.



HUNTER 27te

DRAWING TITLE:

BATTERY CHARGER WIRING

DRAWN BY:

JLK

DATE:

8-JULY-08

SHEET

1

OF

1

SCALE:

HUNTER PART NO.

REVISION

DRAW #

CHECKED

SYMBOL	REVISIONS	DATE	ENG

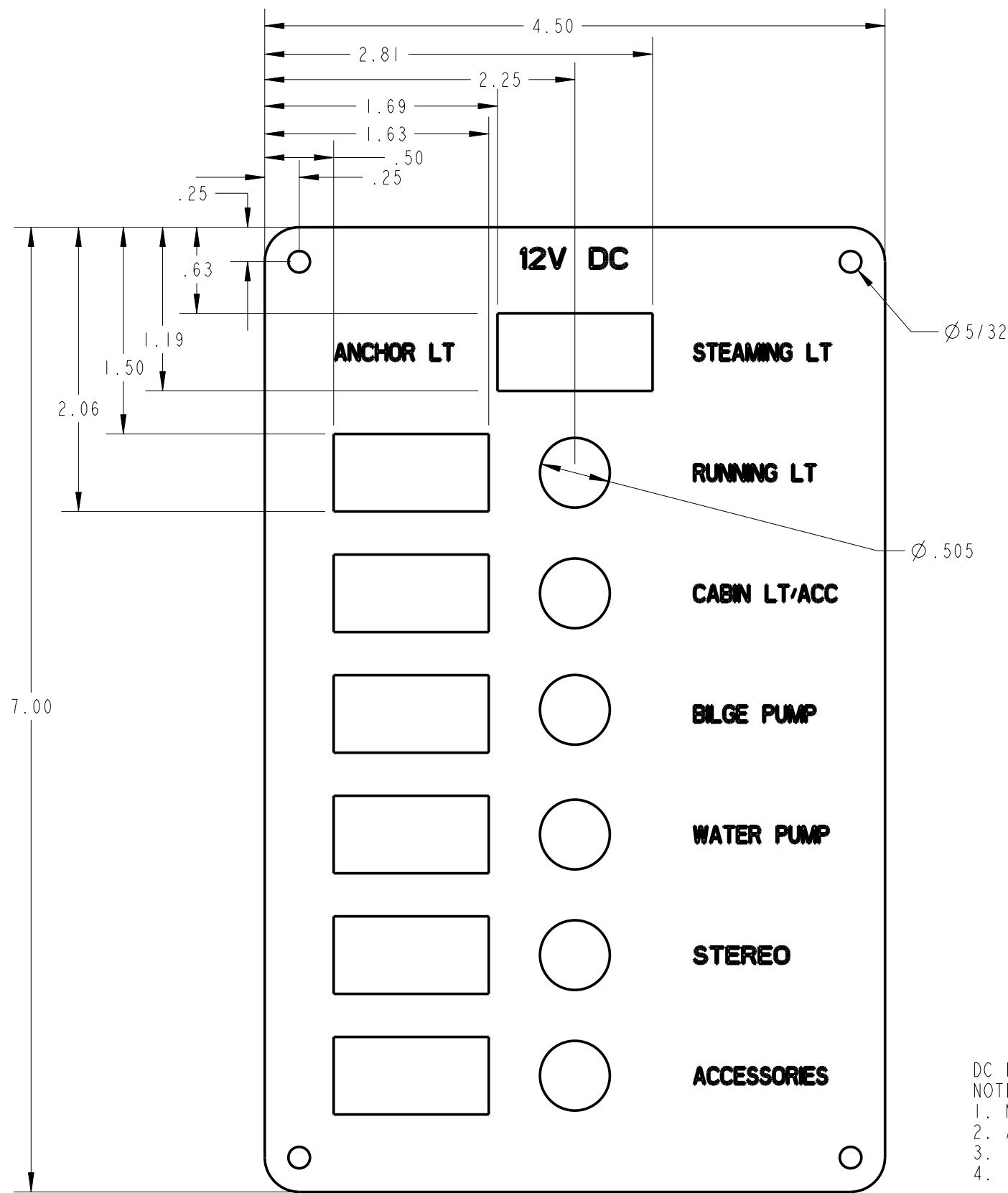

SCALE 1:1

- DC PANEL  
 NOTES: SCALE=1.000  
 1. MATERIAL: PLASTIC OR ALUMINUM  
 2. ALL DIMENSIONS ARE INCHES AND DEGREES  
 3. INCLUDE SWITCHES  
 4. INCLUDE FUSE HOLDERS W/FUSES

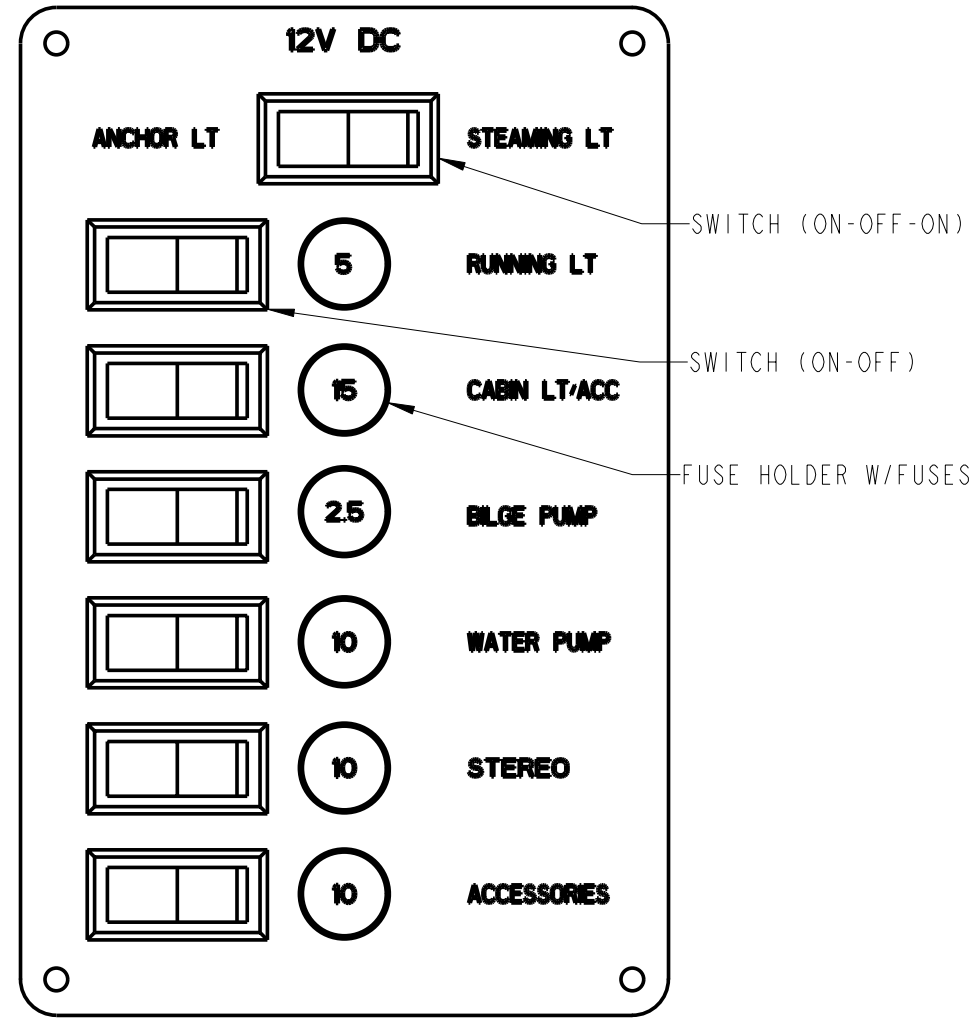

PROPRIETARY INFORMATION: THIS DRAWING CONTAINS INFORMATION FOR WHICH HUNTER MARINE CORPORATION HAS PROPRIETARY RIGHTS.



DRAWING TITLE: <b>DC PANEL</b>			
DRAWN BY: <b>JLK</b>	DATE: <b>25-Sep-07</b>	SHEET <b>1</b>	OF <b>1</b>
SCALE: <b>0.750</b>	HUNTER PART NO. <b>TBD</b>	REVISION <b>-</b>	DRAW # <b>PANEL DC 26PS</b>

CHECKED:

SYMBOL	REVISIONS	DATE	ENG

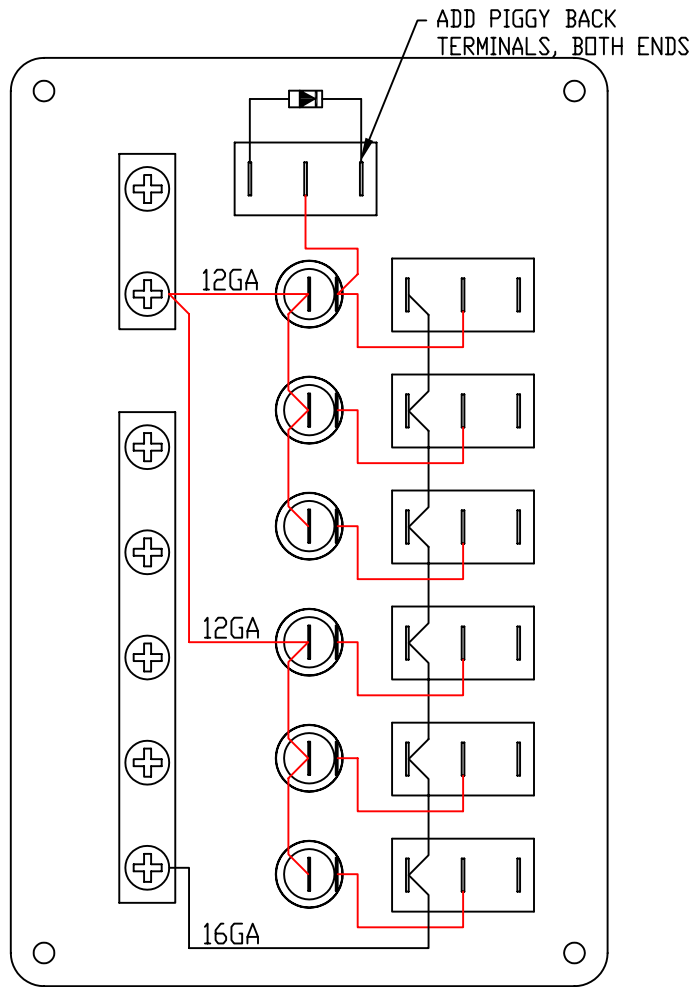

PN 1033664

<small>PROPRIETARY INFORMATION THIS DRAWING CONTAINS INFORMATION FOR WHICH HUNTER MARINE CORPORATION HAS PROPRIETARY RIGHTS.</small>				
		<b>HUNTER</b>		<i>27TE</i>
DRAWING TITLE: <b>DC PANEL, VENDOR SCHEMATIC</b>				
DRAWN BY: <i>JLK</i>	DATE: <i>03-Jun-08</i>	SHEET <i>1</i>	OF <i>1</i>	
SCALE: <i>1.000</i>	HUNTER PART NO. <i>TBD</i>	REVISION -	DRAW # <i>PANEL_DC_27PS_BACKSIDE</i>	

CHECKED



SYMBOL	REVISIONS	DATE	ENG

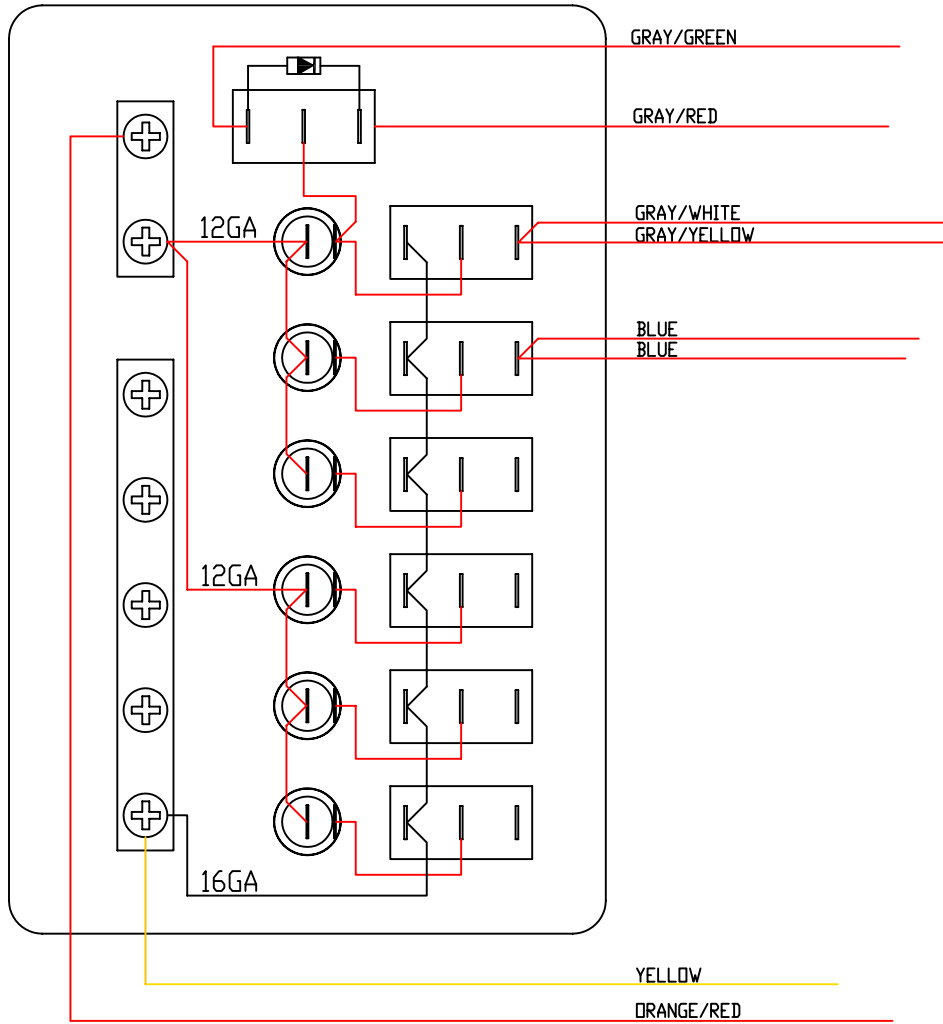

PN 1033664

<small>PROPRIETARY INFORMATION THIS DRAWING CONTAINS INFORMATION FOR WHICH HUNTER MARINE CORPORATION HAS PROPRIETARY RIGHTS.</small>			
	HUNTER	27TE	
DRAWING TITLE: DC PANEL, SCHEMATIC			
DRAWN BY: JLK	DATE: 03-Jun-08	SHEET 1	OF 1
SCALE: 1.000	HUNTER PART NO. TBD	REVISION -	DRAW # PANEL_DC_27PS_BACKSIDE

CHECKED

SYMBOL	REVISIONS	DATE	ENG

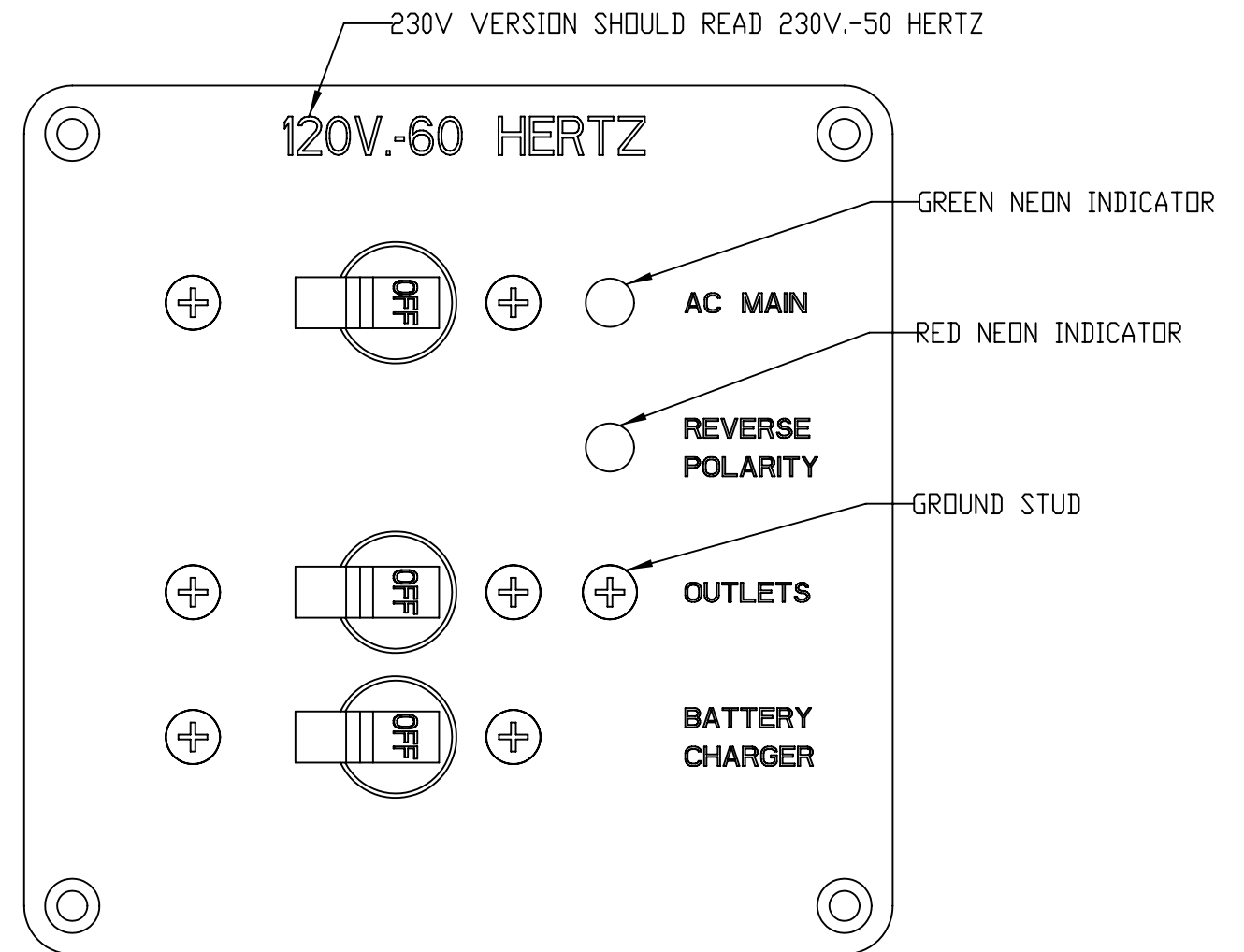
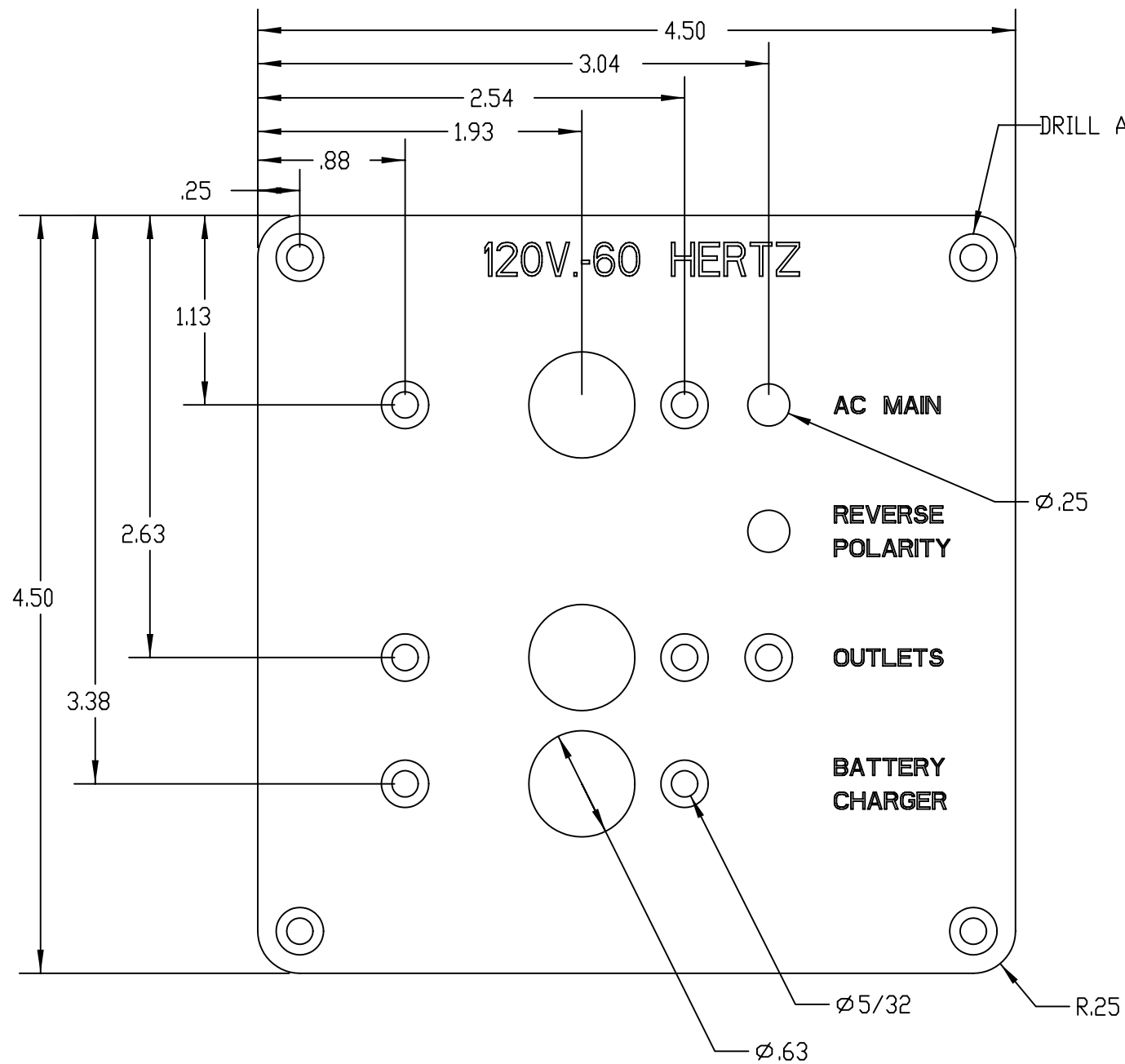

PANEL, 120 OR 230 VOLT AC  
 NOTES: SCALE= 1.000  
 1. MATERIAL: 1/8" ALUMINUM  
 2. FINISH: BLACK MATTE  
 3. TEXT: WHITE FUJI EXTENDED  
 4. ALL DIMENSIONS ARE INCHES AND DEGREES  
 5. BREAK AND DEBURR ALL EDGES  
 6. QUANTITY= 1 PER BOAT

BREAKERS FOR 120 VOLT VERSION:  
 30 AMP DOUBLE- AC MAIN  
 15 AMP - OUTLETS  
 15 AMP - BATTERY CHARGER

BREAKERS FOR 230 VOLT VERSION:  
 15 AMP DOUBLE- AC MAIN  
 10 AMP - OUTLETS  
 10 AMP - BATTERY CHARGER

PROPRIETARY INFORMATION: THIS DRAWING CONTAINS INFORMATION FOR WHICH HUNTER MARINE CORPORATION HAS PROPRIETARY RIGHTS.



DRAWING TITLE: <i>PANEL, 120/230VAC</i>			
DRAWN BY: <i>JLK</i>	DATE: <i>15-Oct-07</i>	SHEET <i>1</i>	OF <i>1</i>
SCALE: <i>1.000</i>	HUNTER PART NO. <i>TBD</i>	REVISION <i>-</i>	DRAW # <i>PANEL ACV 26PS</i>

CHECKED:

SYMBOL	REVISIONS	DATE	ENG

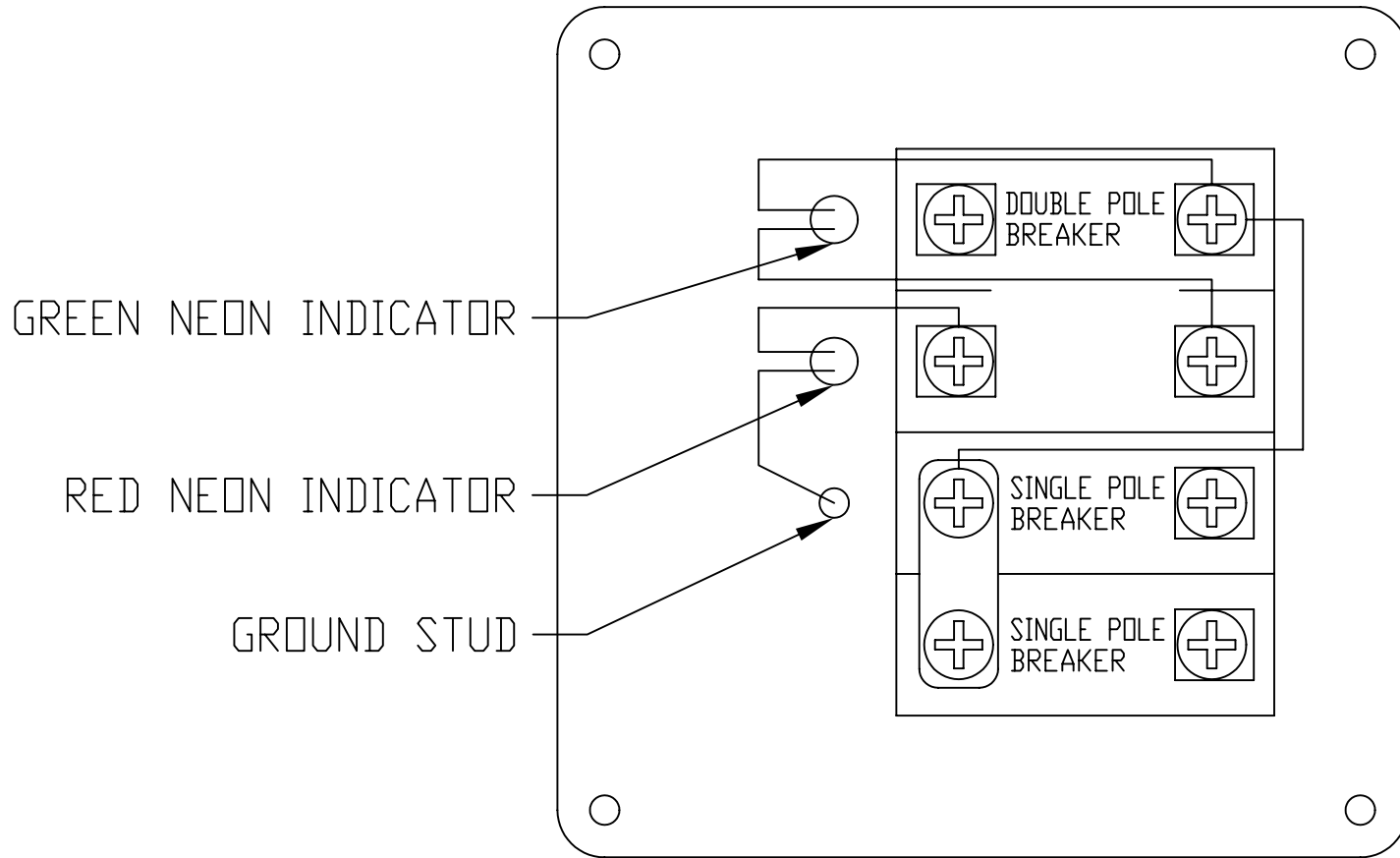

PROPRIETARY INFORMATION: THIS DRAWING CONTAINS INFORMATION FOR WHICH HUNTER MARINE CORPORATION HAS PROPRIETARY RIGHTS.

# HUNTER 26PS

DRAWING TITLE:  
**PANEL, ACV SCHEMATIC**

DRAWN BY: <b>JLK</b>	DATE: <b>15-Oct-07</b>	SHEET <b>1</b>	OF <b>2</b>
SCALE: <b>0.750</b>	HUNTER PART NO. <b>TBD</b>	REVISION <b>-</b>	DRAW # <b>PANEL_ACV_26PS_SCH</b>

CHECKED:

10/3 - MARK "SHORE PWR"  
MOLEX, 19403-1300

SYMBOL	REVISIONS	DATE	ENG
A	ADDED GROUND HARNESS, ADJUSTED LENGTHS AND ADDED MOLEX TO SHORE PWR.	4/23/08	JLK
B	CHANGE LENGTH OF BATT CHARGER TO 12" AND ADDED MOLEX TO BATT CHARGER.	7/8/08	JLK

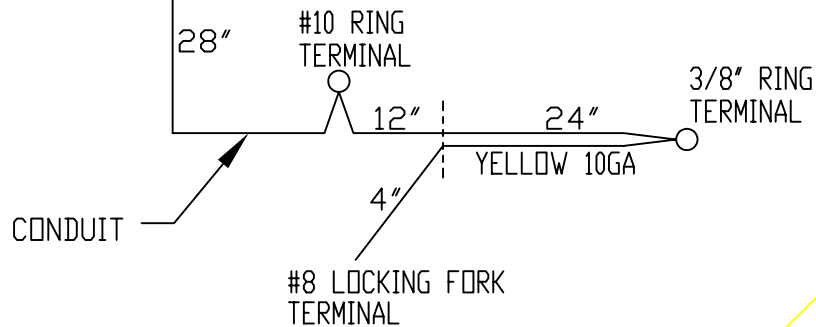
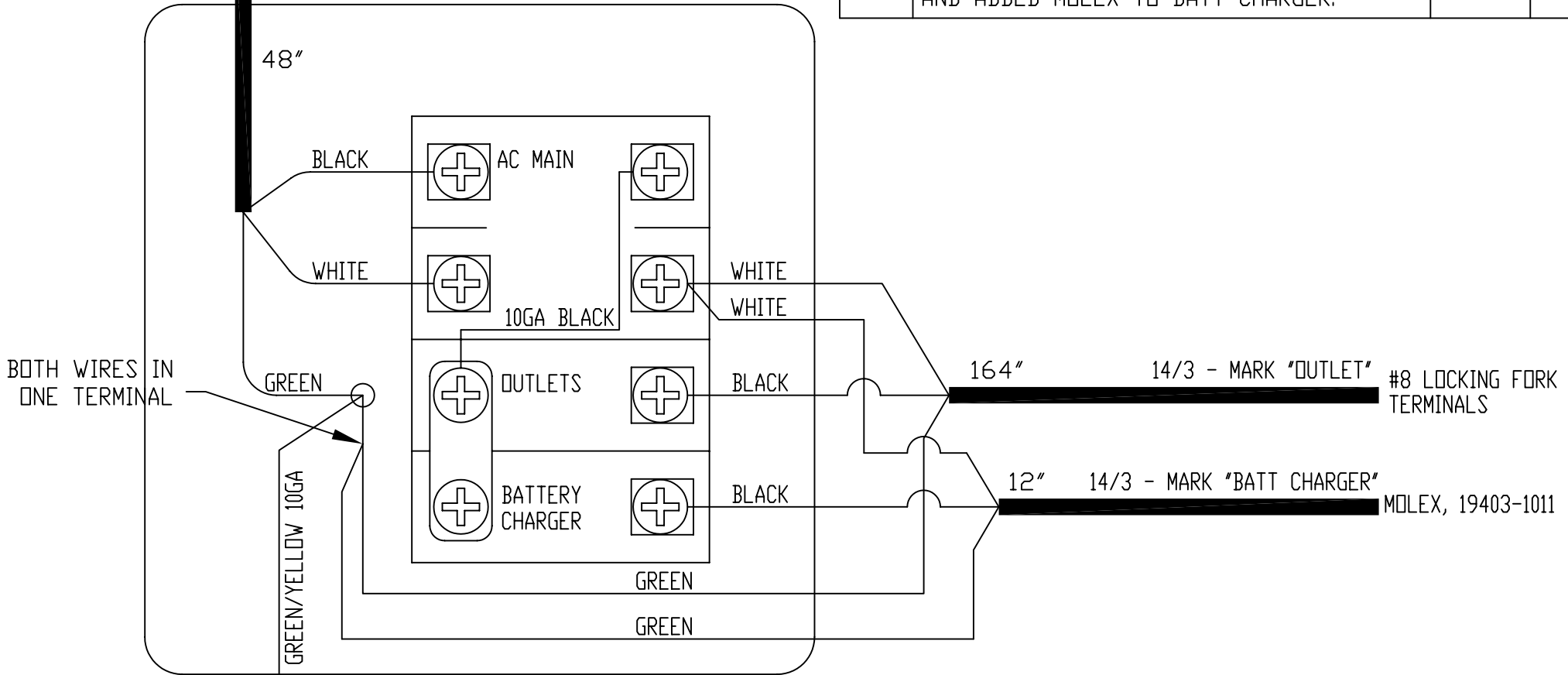

PROPRIETARY INFORMATION: THIS DRAWING CONTAINS INFORMATION FOR WHICH HUNTER MARINE CORPORATION HAS PROPRIETARY RIGHTS.

**HUNTER**  **26PS**

DRAWING TITLE:

**PANEL, ACV SCHEMATIC**

DRAWN BY: <b>JLK</b>	DATE: <b>15-Oct-07</b>	SHEET <b>2</b>	OF <b>2</b>
SCALE: <b>0.750</b>	HUNTER PART NO. <b>TBD</b>	REVISION <b>-</b>	DRAW # <b>PANEL_ACV_26PS_SCH</b>

CHECKED: