

HUNTER

BOOM AND REEF LAYOUT
GEN2615A
CONVENTIONAL REEF

VARIATIONS:

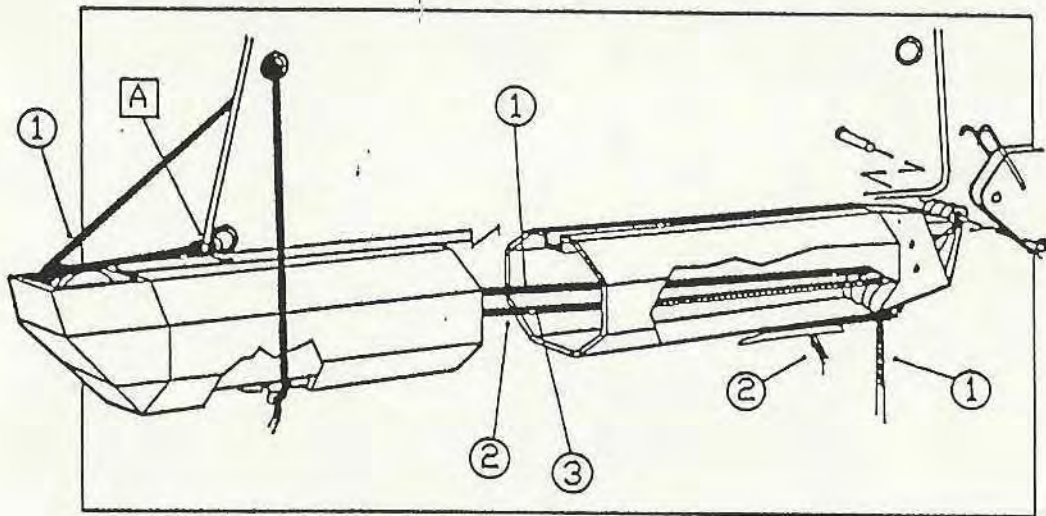
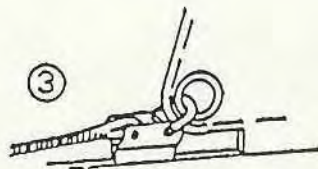
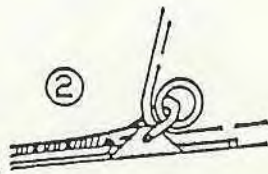

① REEF LINE

② OUTHAUL

③ TRANSITION FROM OH WIRE - OH LINE

A D SHACKLE

Hunter 22

ELECTRICAL DIAGRAM

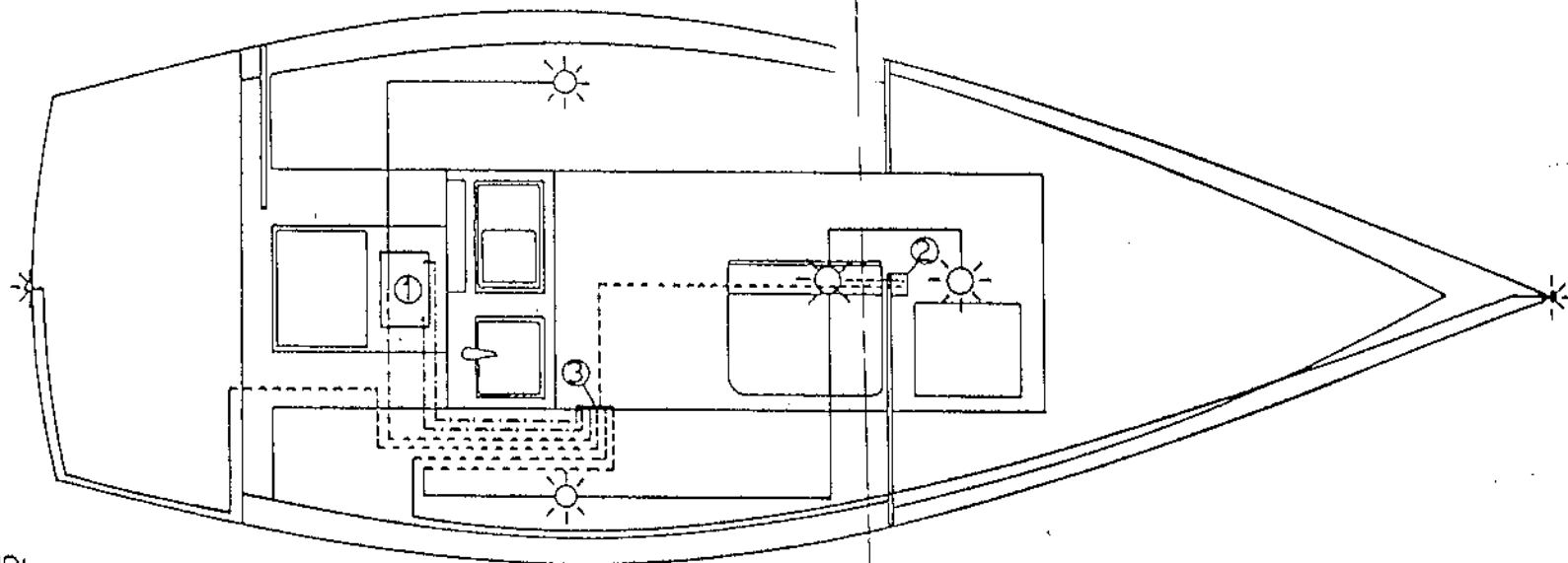



LEGEND:

- ① BATTERY
- ② MAST
- ③ SWITCH PANEL

SYMBOLS:

- 4ga. BATTERY CABLE
- 8ga. MAST GROUND
- 16ga. WIRE (THRU-PAN)
- 16ga. WIRE (THRU-HEADLINER)

-  ROUND CABIN LIGHTS
-  BOW & STERN LIGHTS

WIRING NOTES:

COLOR:	GAUGE:	APPLICATION:
RED	4	BATTERY CABLE
BLACK	8	MAST GROUND
BLUE	16	CABIN LIGHTS
WHITE	16	BOW & STERN LIGHTS
RED	16	MAST LIGHTS

NOTE:

ALL LEADS EXCEPT MAST GROUND ARE RUN WITH A BLACK GROUND OF EQUAL GAUGE. THESE ARE CONNECTED TO A COMMON GROUND AT THE SWITCH PANEL.

Hunter 22'

CENTERBOARD MECHANISM

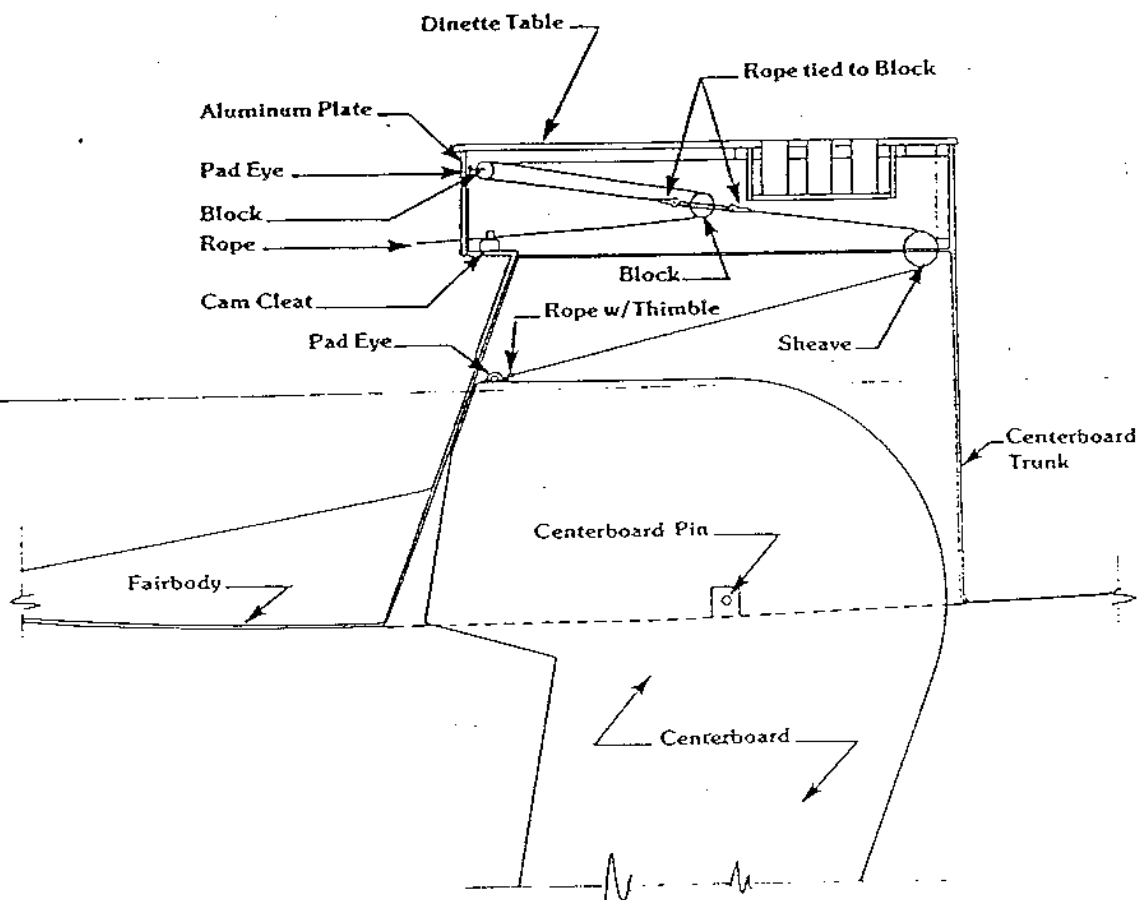

Hunter 22

PLUMBING DIAGRAM

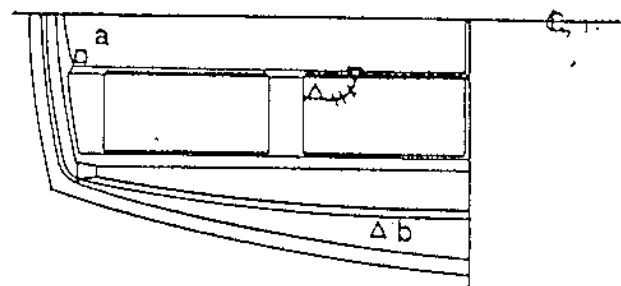
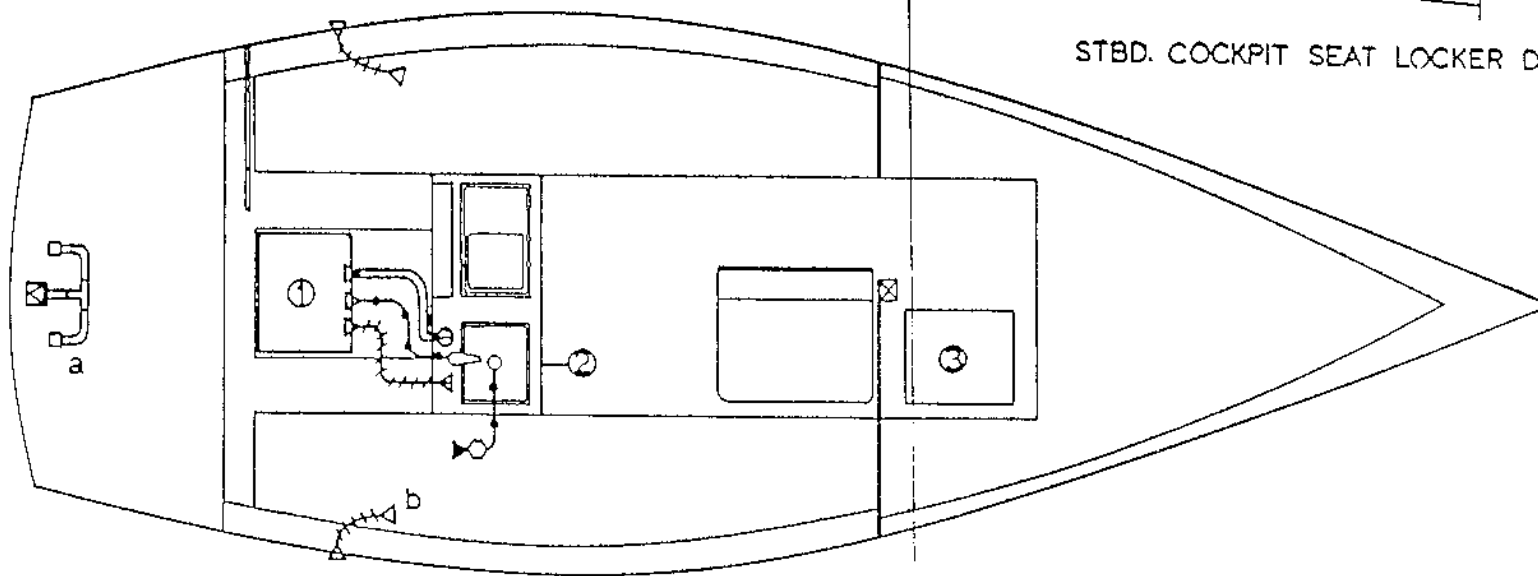

STBD. COCKPIT SEAT LOCKER DRAIN

LEGEND:

- ① MOLDED WATER TANK
- ② GALLEY W/HAND PUMP
- ③ HEAD SANI-POTTI 944

SYMBOLS:

□ 1 1/2" SCUPPER TUBE

⊠ 1 1/2" THRU-HULL SCUPPER TUBE

Δ THRU-HULL (PLASTIC)

▲ THRU-HULL (BRONZE)

○ GATE VALVE

Δ VENT

⊖ WATER FILL PLATE

⊏ PVC TEE

══ 1 1/2" SHIELDVAC W/HOSE CUFFS

++++ 3/4" SHIELDVAC W/HOSE CUFFS

→→ WHITE & BLUE WATER HOSE

HUNTER MARINE LIMITED WARRANTY

Hunter Marine warrants to the first-use purchaser for a period of twelve (12) months from the date of sale any part manufactured by Hunter to be free of defects caused by faulty workmanship or materials under normal use and service.

During this period Hunter Marine will replace any part judged to be defective by Hunter Marine free of charge at its plant or at the option of Hunter, by an authorized Hunter Marine dealer. Transportation costs are the responsibility of the first-use purchaser. The labor cost reimbursement will be based on a labor allowance schedule established by Hunter Marine and, where not applicable, on a reasonable number of hours as determined by Hunter Marine. All repairs and replacements must be approved in advance by an authorized Hunter Marine representative.

The warranty does not cover:

- (1) Paint, window glass, gel coat, upholstery damage, plastic finishes, engines, engine parts, propellers, shafts, controls, instruments and equipment not manufactured by Hunter Marine.
- (2) Boats or parts which have been altered or subjected to negligence or misuse.
- (3) Commercially used boats.

This warranty is expressly in lieu of any and all other remedies and expressed warranties. Any implied warranties, including the warranties of merchantability and fitness are limited to the duration of this limited warranty. Some states do not allow limitations on how long an implied warranty lasts, so that the above limitation may not apply to you.

Any consequential damages which may be incurred are excluded and the liability of Hunter Marine and the purchaser's remedy shall be limited to repair or replacement of any part or party judged defective by Hunter Marine. Some states do not allow the exclusion or limitation of incidental or consequential damages, so the above limitation exclusion may apply to you.

The purchaser acknowledges that no other representations were made to him with respect to the quality and function of the boat.

This warranty gives you specific legal rights and you may have other rights which vary from state to state.

This warranty shall not be effective unless the Hunter Marine warranty card and pre-delivery service record are completed and returned to Hunter Marine within ten (10) days after the date of sale to the first-use purchaser.

PRE-DEPARTURE CHECK-LIST

- Check bilge for excess water.
- Check weather conditions and tides.
- Check food supply.
- Foul weather gear.
- Linen, sleeping bags.
- Fuel.
- Water.
- Sunscreens and sunglasses.
- Tools.
- Docking and anchor gear.
- Check radio operations.
- Navigation charts and instruments.
- Float plans to a friend or Coast Guard. *(See next page.)*
- Fuel for stove.
- Cooking and eating utensils.
- Check battery water level.
- Oil level, tight V-belts.
- Check for loose electrical connections in engine room.
- Secure tools or any loose equipment in engine room so as not to get fouled in engine.
- AC systems off; electrical cord stowed.
- Doors and drawers secured.
- Check steering lock to lock.
- Check mast for rigging irregularities and tightness.
- Halyards and sheets are clear and ready to run.
- No lines or other obstructions near the propeller or bow.
- Anchor ready to run.
- Check lifelines for tightness.
- Turn on fuel and water lines.
- Stow all loose gear.
- Open engine cooling water intake thru-hull valve.

FLOAT PLAN

1. Name of person reporting and telephone number:

2. Description of boat:

NAME _____ TYPE _____

MAKE _____ LENGTH _____ REGISTRATION # _____

HULL COLOR _____ STRIPE COLOR _____ DECK COLOR _____

OTHER DISTINGUISHING MARKS _____

3. Persons aboard:

NUMBER _____

NAME _____ AGE _____ PHONE # _____

ADDRESS _____

NAME _____ AGE _____ PHONE # _____

ADDRESS _____

NAME _____ AGE _____ PHONE # _____

ADDRESS _____

4. Engine:

TYPE _____ H.P. _____ FUEL CAPACITY _____

5. Safety equipment:

PFDs Flares Mirror Flashlight
 Food Water EPIRB Raft/Dinghy

6. Radio:

TYPE _____ FREQUENCIES _____

7. Trip expectations:

DEPARTING AT (APPROX. TIME) _____ ON (DATE) _____ FROM (LOCATION) _____

GOING TO (LOCATION) _____ RETURNING (DATE) _____ IN NO EVENT LATER THAN (TIME & DATE) _____

8. Automobile:

LICENSE # _____ STATE _____

MAKE _____ COLOR _____ PARKED AT _____

9. If not returned by _____, call the Coast Guard or:

at: _____

CLOSING UP YOUR BOAT AFTER SAILING

When leaving your Hunter or Legend at the dock for more than a short time, it is a good idea to review the following check list to make sure everything is in order. This will help protect the various parts of your boat and add considerably to their attractiveness and usable life.

- Fold and bag headsails and stow below.
- Furl mainsail and cover, or remove and also bag.
- Remove and stow all portable deck hardware such as snatch blocks, winch handles, etc.
- Secure the boom to the topping lift and set it firmly amidships with the mainsheet purchase. (It is also a good idea to rig a line from the steering wheel or tiller to a convenient cleat to keep the rudder from swinging back and forth with the motion of the water.)
- Attach the shackle ends of all halyards to convenient fittings and take up slack.
- Cleat and coil halyard tails and permanent sheets, hanging them off the deck to promote drying.
- Coil and stow all other lines.
- Cover the winches and steering pedestal when leaving the boat for several days or more.
- Close all fuel lines and gate valves.
- Turn off the electrical system.
- Pump the bilge.
- Check air vents, secure ports and hatches, and swab the deck, particularly if you have operated on saltwater.
- Make a final check of mooring lines, chafing gear, fenders, etc.

FOR SAFE BOATING

BE PREPARED

Take a safe boating course from the Coast Guard. You can call 800-336-BOAT for information on courses in your area.

Carry all safety equipment required by federal and state law. Federal requirements are discussed in "Federal Requirements for Recreational Boats" which can be acquired from U.S. Coast Guard Office of Boating, Public, and Consumer Affairs, Washington, D.C. 20593. State requirements will come from your local State Boating Administration. The Coast Guard also recommends a first-aid kit, a pump or bailer, a transistor or weather radio, extra fuel, a paddle, anchor and line, and extra drinking water; also, if not a requirement, flares.

Get a Coast Guard Auxiliary Courtesy Examination. This is a free, confidential safety inspection. Call your local Coast Guard Auxiliary for details.

Be familiar with the use of distress signals and PFDs.

AVOID FIRES

Handle fuels carefully,

Read the engine owner's manual for proper fuel-system maintenance and inspect your engine's fuel system periodically.

Heed fire extinguisher regulations and keep them in good condition.

While refueling:

- a. Fill the portable tanks on the dock.
- b. Tie the boat securely.
- c. Extinguish cigarettes and all flames on the boat. Turn off all engines and electrical equipment.
- d. Keep the hose nozzle in contact with the fuel can or fill.
- e. Wipe up all fuel spillage.
- f. Ventilate the engine and fuel compartment.
- g. Check boat for fumes.

BEFORE GETTING UNDERWAY

Leave a float plan. (See example on page I-5.)

Perform pre-departure check list. (See check list on page I-4.)

Check the weather: do not venture out if the weather is threatening.

WHILE UNDERWAY

PFDs should be worn by children and non-swimmers at all times. *Everyone should wear them if conditions become hazardous.*

Do not operate a boat if intoxicated, fatigued or stressed. These human factors cause 50 percent of all boating accidents.

Keep a good lookout. This is especially true of sailboats. Keep a watch to leeward under the headsail. Keep away from swimmers, divers and skiers.

Obey state and federal laws. Know your local laws and "rules of the road."

Respect bad weather: try to get to shore if the weather turns bad. Get and carry a radio with a NOAA "weather band" on FM 162.40-162.55MHZ.

FOR SAFE BOATING *(Continued)*

IF TROUBLE OCCURS

Radio for help. Use the emergency VHF channel (i.e., 156.8MHZ).

Put on PFDs immediately.

Stay with the boat. In cold water, huddle together to prevent hypothermia.

FLOAT PLAN

Make copies of the example on page I-5 and use one before each trip. Fill it out and leave it with a reliable person who will notify the Coast Guard or other rescue organization if you fail to return on time. **Do not forget to cancel the float plan upon your return.**

BRIEF GLOSSARY OF SAILING TERMS

BATTEN: A thin wooden or plastic strip placed in a pocket in the leech of a sail to help hold its form.

BLOCK: Pulley consisting of a frame in which is set one or more sheaves or rollers. Ropes are run over these rollers.

BOOM: Spar at the foot of the mainsail.

BOOM VANG: Tackle secured to the bottom of the boom about three feet aft of the gooseneck. The other block attaches to an eye at the base of the mast. The vang's purpose is to keep the boom steady and horizontal while sailing.

CHAINPLATES: Strips of metal fastened to the boat's hull or deck designed to take the stress of stays.

CLEVIS PIN: A small stainless steel pin that has a hole in one end for a cotter pin and is used to secure stays to chainplates and mast fittings.

CLEW: The aft-most lower corner of a sail.

COTTER PIN: A straight or circular split metal pin used to hold a clevis pin in place.

DOWNHAUL: A device used to tighten the luff of a sail.

FAIRLEAD: An eye used to lead line in the direction desired.

FOOT: The lower edge of a sail.

GOOSENECK: A metal device that secures the boom to the mast.

GUDGEON: A metal socket attached to the transom to receive the pintle of the rudder.

GUNWALES: The upper edge of a boat's side where it meets the deck.

HALYARD: A line for hoisting (or raising) the sails.

HEAD: The upper corner of a sail.

HEADBOARD: The fitting at the head of a sail with a hole in it to receive the main halyard.

HEADSTAY: The foremost stay on a sailboat. A jib is set on a headstay.

JIB SNAPS: Small fittings that are attached to the luff of a jib which secure the jib to the headstay.

JIBE: The action of the mainsail when shifting from one side of the boat to the other when heading downwind.

JIFFY REEFING: (*see "reefing"*) A quick method of reefing the mainsail, sometimes with one line.

LEECH: The aft edge of a sail.

LUFF: The forward edge of a sail.

MAINSHEET: The line used to trim a mainsail.

MASTHEAD FITTING: The fitting at the top of a mast.

BRIEF GLOSSARY (Continued)

- MAST STEP:** A metal fitting that holds the base of the mast in position.
- OUTHAUL:** A line used to haul the clew of a sail out to the edge of the boom.
- PINTLES:** Pins on the forward side of a boat's rudder, designed to rest in and pivot on the gudgeons secured to the transom.
- REEFING:** To reduce a sail by rolling or folding up part of it.
- RIGGING:** The wire supporting the spars is called standing rigging (stays or shrouds), and the ropes used in setting and trimming sails are known as running rigging (halyards and sheets).
- ROLLER FURLING:** A means of reducing sail on a main or jib by rolling the sail around a rod or wire.
- SHACKLE:** A U-shaped piece of metal with a pin across the open ends.
- SHEET:** A rope used to trim a sail.
- SHROUD:** A length of wire used to support a spar (same as a "stay").
- SLACK:** The opposite of taut (i.e., *slack away or off*—to pay out).
- SPREADERS:** Aluminum tubes that project from a mast in a traverse direction in order to keep a stay at proper tension and to help hold the mast erect.
- STAY:** A length of wire used to support a spar (same as a "shroud").
- STEMHEAD FITTING:** The fitting nearest the bow on the deck where the headstay attaches.
- STEP:** To step a mast is to set it in position.
- TACK:** The lower forward corner of a sail.
- TILLER:** A piece of wood connected with the rudder head. By this the rudder is moved as desired.
- TOPPING LIFT:** A wire and/or rope that attaches to the top of the mast and fastens to the end of the boom. Its purpose is to hold the end of the boom up when the mainsail is lowered.
- TRIM:** To trim sails. To put them in correct relation to the wind by means of sheets.
- TURNBUCKLE:** A device used to maintain correct tension on rigging.



DIESEL ENGINE

An engine owners manual is supplied with your boat and should be read thoroughly. The manual contains technical specifications, running instructions and maintenance schedule on lubricants and fluids. For long engine life, follow routine maintenance schedules.

You should check engine oil, transmission fluid, and coolant levels. Water, rust, scale and dirt will cause serious damage to the injectors on diesel engines. You should check your filters frequently and change when necessary.

If you start your engine, run it a minimum of 15 minutes to bring it up to operating temperature. This insures that any condensation is evaporated. Your engine should "run-out", at 3/4 throttle, at least once a month to clean out carbon build up and moisture.

STARTING:

1. Visually check engine compartment to see that the throttle linkage, shifting controls, electrical connections and fuel lines are properly secured.

2. BEFORE EACH START check oil in engine and transmission.

3. Insure that engine shut-off cable is properly secured and operating.

4. Place the shift lever (Fig. 1a) in the neutral position.

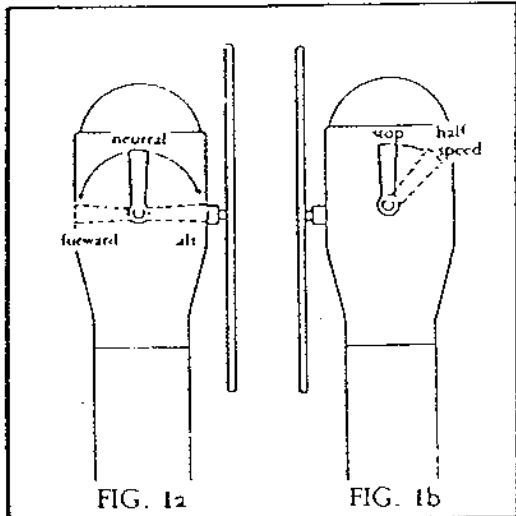

5. Move the throttle or "fuel" lever (Fig. 1b) forward to approximately the half speed position.

6. Insert the starter key and turn to the "ON" position.

7. Press the starter button and hold until engine starts, then release. The buzzer and/or light should then go off.

8. Back the throttle off to an idle position (700-800 rpm) allow cold engine to warm up a minimum of 5 minutes.

9. Check to see that the lube oil pressure warning light and the charge lamp go off.

If any of the warning lamps do not go off above 1000 rpm, the engine is malfunctioning and should be stopped immediately. Consult your nearest engine dealer.

NOTE: To stop engine at any time, pull "fuel" lever all the way aft (Fig. 1b). Before stopping, however, it is a good idea to idle the engine in neutral for about 5 minutes, then race it in the full throttle position for a moment, then return to idle and stop the engine.

CAUTION: DO NOT TURN SAFETY MAIN SWITCH TO "OFF" WHILE ENGINE IS RUNNING. THIS CAN SERIOUSLY DAMAGE THE ALTERNATOR.

MOTORING:

When engine is warm, you may move the "shift" lever either forward to go ahead or aft to move in reverse (Fig. 1a).

CAUTION: your rigging will conduct electricity. Always check for overhead high tension wires before proceeding. Once clear, you may increase your speed in a reasonable and safe manner as desired.

IMPORTANT: do not shift from forward to reverse or back without first lowering engine rpm.

HUNTER



4. To prevent corrosion inside the cylinders, pour a little lubricating oil into the suction pipe while turning the engine. Enough oil to reach the intake/exhaust valves is sufficient.

5. Put the piston at top dead center of compression stroke so that the intake/exhaust valves are completely closed.

6. Apply a thin anti-corrosion treatment to the plating and exposed painted surfaces.

7. The engine should be in a well-ventilated area, and protected from any kind of dampness.

8. Put a dust cover over the engine.

9. Check your operation manual for engine diagram and for **MANUFACTURERS RECOMMENDED WINTERIZING PROCEDURES.**

HUNTER



WINCH MAINTENANCE

Follow the maintenance instructions prescribed by the winch manufacturer.

GENERAL MAINTENANCE OF HARDWARE

Check all fittings regularly to be sure screws are tight.

Occasionally lubricate all moving parts on such fittings as blocks, turnbuckles and cam cleats, as well as the locking pins of snatch blocks, track slides, spinnaker poles, etc.

Inspect chocks, cleats and fairleads for roughness and smooth with finegrained emery paper if necessary.

Also, replace any missing or damaged cotter pins in turnbuckles and shackles, and either tape them or use protective covers manufactured for that purpose.

STORING YOUR BOAT FOR WINTER

IMPORTANT: Winter storage should be on the cradle supplied with the boat. The cradle should be blocked level and square to prevent twisting the boat. Damage to your boat, including engine misalignment caused by twisting, is not covered by the warranty.

SAILS

Sails and synthetic lines should be washed and dried thoroughly. Sails should be properly folded and stowed in a dry, well ventilated place. Many sailboat owners send their sails back to the sail manufacturer at the end of each season. The sailmaker will check the stitching and sailcloth for wear and store the sails until the start of the next season.

CUSHIONS

Cushions should be removed and stored at home if possible. If not, prop them vertically to promote airflow around each cushion.

HATCHES

Hatches and floorboards should be left open a crack to provide ventilation for the whole boat. However, it is prudent to loosely cover any open hatches with a tarp or plastic sheeting.

WATER SYSTEM

Open a faucet and allow the pump to empty the tank. Then add approximately 2 gallons of *non-toxic* anti-freeze solution to the tank and repeat the pumping out process.

A second method is to disconnect the hoses at the pump, allowing them to drain. Find the lowest point in the system and disconnect the fitting. Open all faucets to allow the lines to drain. If possible, use a short piece of hose on the faucet to blow through the lines to clear all water.

HOT WATER HEATER

Open valve and drain fully. Leave valve open during lay-up-time.

TOILET AND HOLDING TANK

Drain and flush toilet. Using automotive anti-freeze (ethyleneglycol) in a 50/50 mixture with water, pump through toilet and into holding tank.

ENGINE

1. Drain the cooling water completely out of the engine and flush the line thoroughly with fresh water. Don't use high pressure through the line.
2. Remove the fuel completely from all fuel lines.
3. Disconnect the main battery cables from the battery terminals.

HUNTER



CARE OF RUNNING RIGGING

To protect your running rigging (sheets, halyards) from damage, wash with cold water (and a mild detergent, if necessary), especially after exposure to salt water. Rinse thoroughly and coil. Hang the tail ends of halyards off the deck to promote drying. Sheets should also be hung to dry.

Inspect all lines periodically for fraying and other damage. Lines showing substantial wear should be replaced.

CARE OF STANDING RIGGING

The stays and shrouds on your Hunter are highly durable stainless steel to insure years of reliable service. To protect your standing rigging, keep it clean, and, whenever possible, rinse thoroughly with fresh water. Check occasionally for "fishhooks," strands of wire that have broken and curled outward. These can snag sails and inflict painful cuts in bare hands. Broken strands indicate the wire is deteriorating and should be replaced.

Also inspect turnbuckles regularly and replace any missing cotter pins. Occasional lubricating improves both the life and the function to turnbuckles.

ENGINE ALIGNMENT

The engine should be aligned by experienced marine service personnel. Final alignment should be done after launching, with all normal gear aboard. A description of the procedure follows.

The coupling flanges must come together evenly at all points, a feeler gauge is used to check the gap. If adjustment is necessary, the engine is tilted up or down, and/or side to side until the flanges meet equally. Severe vibration will result from misalignment and can cause strut bearing and shaft damage.

Alignment should be checked again after several weeks of use.

SHAFT LOG

The stuffing box is held to the shaft log tube by a rubber tube, secured by hose clamps. The clamps should be tight and no water should leak from this location.

A slight drip from the stuffing box at the shaft exit is necessary (4 drops a minute).

To adjust, loosen lock nut, tighten gland nut 1/4 turn, retighten lock nut. If excessive water flow persists after adjustment, replace the packing and then adjust as above.

IV. Maintenance

A. Engine, Transmission and Drivetrain

ENGINE:

Follow the fuel and lubrication requirements in the Engine Manual. Check the engine oil level before and after operation and use quality motor oil (refer to Engine Manual). Be certain the proper amount of oil is in the crankcase at all times.

Engine alignment: The engine should be aligned by experienced marine service personnel. Final alignment should be done after launching, with all normal gear aboard. A description of the procedure follows:

The coupling flanges must come together evenly at all points, a feeler gauge is used to check the gap. If adjustment is necessary, the engine is tilted up or down and/or side to side until the flanges meet equally. Severe vibration will result from misalignment and can cause strut bearing and shaft damage.

Alignment should be checked again after several weeks of use. (Refer to this manual's alignment drawing.)

TRANSMISSION:

Follow the lubrication requirements of the Engine Manual. The oil level should be checked immediately after operation.

DRIVETRAIN:

The shaft log (stuffing box) should be inspected periodically.

The stuffing box is held to the shaft log tube by a rubber tube secured by hose clamps. The clamps should be tight and no water should leak from this location: A slight drip from the stuffing box at the shaft exit is necessary (four drops a minute) and normal.

To adjust, loosen the lock nut, tighten gland nut one-quarter turn, and retighten lock nut. If excessive water flow persists after adjustment, replace the packing and then adjust as above.

B. Steering

The manufacturer's instructions for maintaining pedestal steering system should be followed closely. Wires should be periodically inspected for proper tension. Lightly oil all wire.

C. Electrical Systems

The electrical system is a 12-volt, negative ground installation. The owner should periodically inspect battery(ies) and cables for signs of corrosion, cracks, and electrolyte leakage.

D. Plumbing Systems

All pumps should be checked frequently to insure proper operation. This

is an especially important regular maintenance item since proper functioning of a pump could save your vessel from serious damage in the future.

Inspect all hoses for chafing and dry rot. See that hose clamps are tight. Check that the pump impeller area is clean and free of obstructions.

Inspect electrical wiring for corrosion. Make sure float switches move freely and are making an electrical connection.

The owner should become familiar with the layout of the water and waste systems by walking through the boat with the diagrams provided in this manual. It is especially important that the owner knows all thru-hull valve locations and inspects for leaks frequently.

General Thru-hull List (*varies from boat to boat—see diagrams in section VI*)

- 1) Engine cooling system
- 2) Galley sink
- 3) Head sink
- 4) Head toilet (water intake)
- 5) Holding tank discharge
- 6) Scupper drains

E. Fuel System

The owner should inspect the condition of fuel lines for cracks or leaks. A primary source of fuel-related problems is water in the system. The owner should seek out only well maintained fueling facilities and make sure fuel fill ns are tightly secured after filling. Check and maintain fuel filters periodically.

F. General Care

CLEANING FIBERGLASS SURFACES:

Fiberglass surfaces should be cleaned regularly. Normal accumulations of surface dirt can be removed simply by occasional rinsings with water. If your boat is operated in salt water, more frequent rinsing will be required. To remove stubborn dirt, grease or oil, use a mild detergent and a soft brush. Rinse with clean fresh water.

It is also a good idea to wax the fiberglass once or twice a year to maintain a deep, glossy appearance. Your local marine supply should be able to provide an appropriate wax.

FIBERGLASS REPAIRS:

Your Hunter or Legend dealer can supply you with the proper gel coat used to repair any hairline cracks or chips.

1. Using a mild detergent solution, clean repair area completely of wax, dirt or oil, and dry completely.
2. To patch "spiderweb" or hairline cracks, begin by widening the crack so that it will hold putty. This is most easily done with an electric drill or router equipped with a V-shaped grinding bit. Also, cut one-quarter inch or so beyond the end of each crack to relieve any stress.
3. Brush away all dust from the crack.
4. Mix gel coat with filler powder to form a creamy consistency. Mix more than enough patching compound to do the job and stir to a smooth blend.

Temperatures should be in the 60s or above, or a heat lamp should be used for application.

5. Using a putty knife, work the mixture firmly into the crack to eliminate air bubbles. Leave an excess of about one-sixteenth of an inch above the surface of the crack to allow for shrinkage. Wet sand and buff (with compound) the repaired area.

TEAK CARE:

Teak wood is an extremely durable wood with a high oil content. To maintain that durable quality it should be given a coat of teak oil once a year or more in northern climates and twice a year or more in tropical climates.

Teak can be allowed to weather out, as seen on many boats, but this will eventually lead to cracking and splitting.

If you wish to maintain your teak with varnish, resin or urethane, a sealer should be applied after cleaning and sanding. Complete finishing procedures can be obtained from your marine finish products manufacturer or supplier.

FABRIC CARE:

Cushions should be removed and stored at home if possible. If not, prop them vertically to promote airflow around each cushion.

WINCH MAINTENANCE:

Follow the maintenance instructions prescribed by the winch manufacturer.

GENERAL HARDWARE MAINTENANCE:

Check all fittings regularly to be sure screws are tight. Occasionally lubricate all moving parts on such fittings as blocks, turnbuckles and cam cleats, as well as the locking pins of snatch blocks, track slides, spinnaker poles, etc.

Inspect chocks, cleats and fairleads for roughness and smooth with fine-grained emery paper if necessary.

Also, replace any missing or damaged cotter pins in turnbuckles and shackles, and either tape them or use protective covers manufactured for that purpose.

G. Engine

1. Drain the cooling water completely out of the engine and flush the line thoroughly with freshwater. Don't use high pressure through the line.
2. Remove the fuel completely from all fuel lines.
3. Disconnect the main battery cables from the battery terminals.
4. To prevent corrosion inside the cylinders, pour a little lubricating oil into the suction pipe while turning the engine. Enough oil to reach the intake/exhaust valve is sufficient.
5. Put the piston at top dead center of compression stroke so that the intake/exhaust valves are completely closed.
6. Apply a thin anti-corrosion treatment to the plating and exposed painted surfaces.
7. The engine should be in a well ventilated area, and protected from any kind of dampness.
8. Put a dust cover over the engine.
9. Check your operation manual for engine diagram and for "Manufacturer's Recommended Winterizing Procedures."

H. Outboard Engine

1. Take it home and store it in a safe place. Be *very careful* storing the gas tank as the gasoline is very flammable.

STORAGE/WINTERIZATION

IMPORTANT: Winter storage is recommended to be done in one of the following three ways, either: 1) by blocking the boat via a cradle; or 2) with chained stands on level ground; or 3) by storing the boat in the water with a bubbler system to prevent icing. Damage to your boat, including engine misalignment caused by twisting, is not covered by the warranty.

SAILS

Sails should be properly folded and stowed in a dry, well ventilated place. Many sailboat owners send their sails back to the sail manufacturer at the end of each season. The sailmaker will check the stitching and sailcloth for wear and store the sails until the start of the next season.

ELECTRICAL

Remove battery from boat. (Refer to Engine Manual.) and charge. It is a good idea to also to remove the electronics (Radio, Radar, etc.) and store in a safe place.

CUSHIONS

Cushions should be removed and stored at home if possible. If not, prop them vertically to promote airflow around each cushion. *Dry Clean Only!*

HATCHES

Tenting the deck during storage will help prevent ice from forming and damaging hatches and deck fittings. The installation of a passive vent will help with ventilation while the boat is in storage.

WATER SYSTEM - WATER HEATER

WATER SYSTEM:

Open a faucet and allow the pump to empty the tank. Then add approximately two gallons of non-toxic anti-freeze solution to the tank and repeat the pumping out procedure. —

A second method is to disconnect the hoses at the pump, allowing them to drain. Find the lowest point in the system and disconnect the fitting. Open all faucets to allow the lines to drain. If possible, use a short piece of hose on the faucet to blow through the lines to clear all water. A diluted solution with baking soda will help freshen the system.

WATER HEATER:

Open valve and drain fully. Leave valve open during lay-up time.

TOILET AND HOLDING TANK

Drain and flush toilet. Using automotive anti-freeze (ethyleneglycol) in a 50/50 mixture with water, pump through toilet and into holding tank. Refer to Galley/Head section for instructions.

Hunter

TYPICAL KEEL INSTALLATION

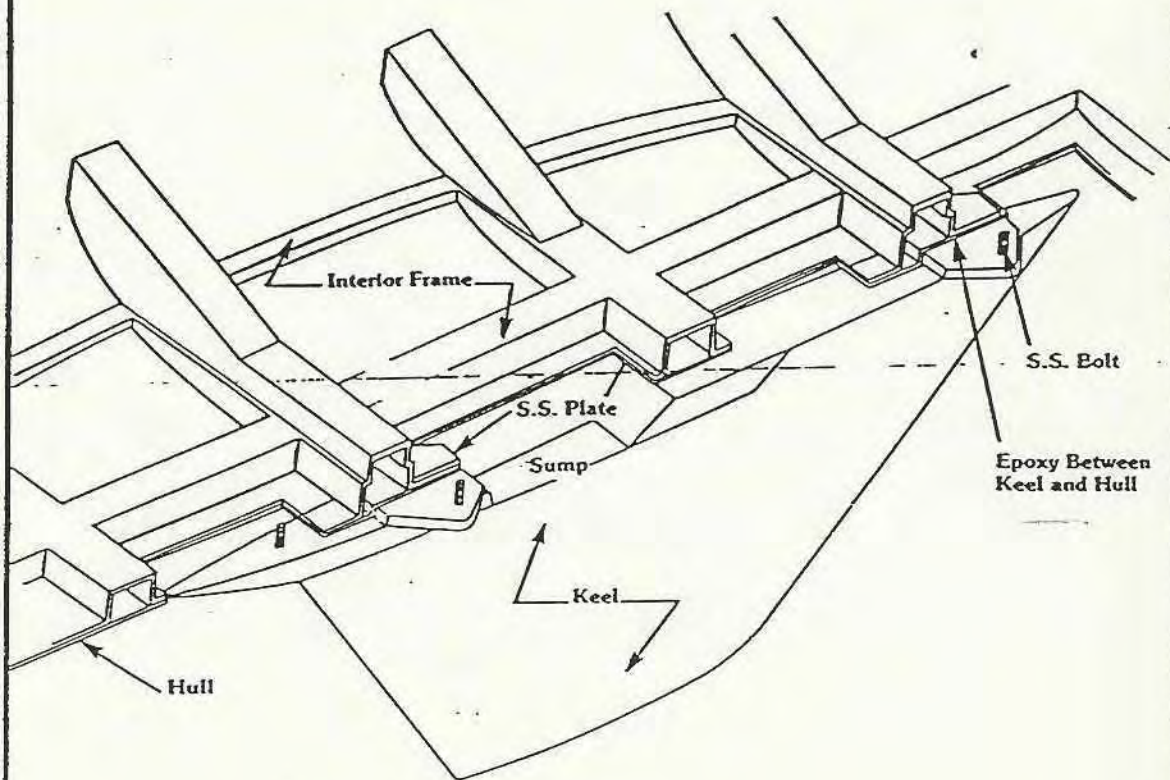

V. Storage/Winterization

IMPORTANT: Winter storage is recommended to be done in one of the following three ways, either: 1) by blocking the boat via a cradle; or 2) with chained stands on level ground; or 3) by storing the boat in the water with a bubbler system to prevent icing. Damage to your boat, including engine misalignment caused by twisting, is not covered by the warranty.

A. Sails

Sails and synthetic lines should be washed and dried thoroughly. Sails should be properly folded and stowed in a dry, well ventilated place. Many sailboat owners send their sails back to the sail manufacturer at the end of each season. The sailmaker will check the stitching and sailcloth for wear and store the sails until the start of the next season.

B. Electrical

Remove battery from boat. (Refer to Engine Manual.)

C. Cushions

Cushions should be removed and stored at home if possible. If not, prop them vertically to promote airflow around each cushion.

D. Hatches

Hatches and floorboards should be left open a crack to provide ventilation for the whole boat. However, it is prudent to loosely cover any open hatches with a tarp or plastic sheeting.

E. Water System—Water Heater

WATER SYSTEM:

Open a faucet and allow the pump to empty the tank. Then add approximately two gallons of *non-toxic* anti-freeze solution to the tank and repeat the pumping out procedure.

A second method is to disconnect the hoses at the pump, allowing them to drain. Find the lowest point in the system and disconnect the fitting. Open all faucets to allow the lines to drain. If possible, use a short piece of hose on the faucet to blow through the lines to clear all water.

WATER HEATER:

Open valve and drain fully. Leave valve open during lay-up time.

F. Toilet and Holding Tank

Drain and flush toilet. Using automotive anti-freeze (ethyleneglycol) in a 50/50 mixture with water, pump through toilet and into holding tank.

STORAGE/WINTERIZATION CONTINUED.

ENGINE

1. Drain the cooling water completely out of the engine and flush the line thoroughly with fresh water. Don't use high pressure through the line.
2. Remove the fuel completely from all fuel lines.
3. Disconnect the main battery cables from the battery terminals.
4. To prevent corrosion inside the cylinders, pour a little lubricating oil into the suction pipe while turning the engine. Enough oil to reach the intake/exhaust valve is sufficient.
5. Put the piston at top dead center of compression stroke so that the intake/exhaust valves are completely closed.
6. Apply a thin anti-corrosion treatment to the plating and exposed painted surfaces.
7. The engine should be in a well ventilated area, and protected from any kind of dampness.
8. Put a dust cover over the engine.
9. Check your operation manual for engine diagram and for "Manufacturer's Recommended Winterizing Procedures."

OUTBOARD ENGINE

Take it home and store it in a safe place. Be very careful storing the gas tank as the gasoline is very flammable. Refer to "Engine Manual" for specific maintenance schedule.

DEPARTURE FROM THE BOAT

The check list for leaving a boat unattended is very important because items overlooked often will not be remembered until you are far from the boat and corrective actions are impractical or impossible. Primary choices for this list are items relating to the safety and security of the unattended craft—turning off fuel valves, the proper settings for electrical switches, pumping out the bilge and leaving the switch on automatic (or arranging for periodic pumping out). Other departure check list items are securing ports, windows, hatches, and doors.

ROUTINE MAINTENANCE

Routine maintenance check lists should include items based on how much the boat is used (usually in terms of engine hours) and on calendar dates (weekly, monthly, or seasonal checks). Typical of the former are oil level checks and changes, and oil and fuel filter changes.

On a calendar basis the lists should note such matters as electrolyte levels in storage-batteries, pressure gauges on dry-chemical fire extinguishers, and all navigation lights. Check the operation of automatic bilge alarms or pump switches by running water into the boat. Periodically close and open seacocks several times to ensure their free and easy operation in case they are needed in an emergency. Equipment and supplies carried on board for emergencies should be inspected for any signs of deterioration.

ORIGO 1500, 3000

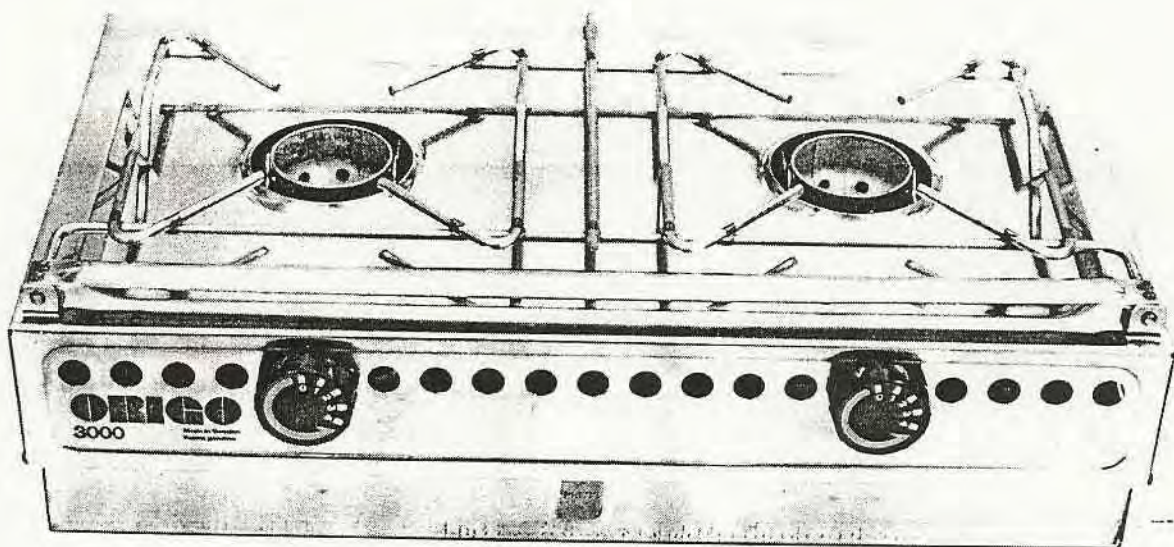
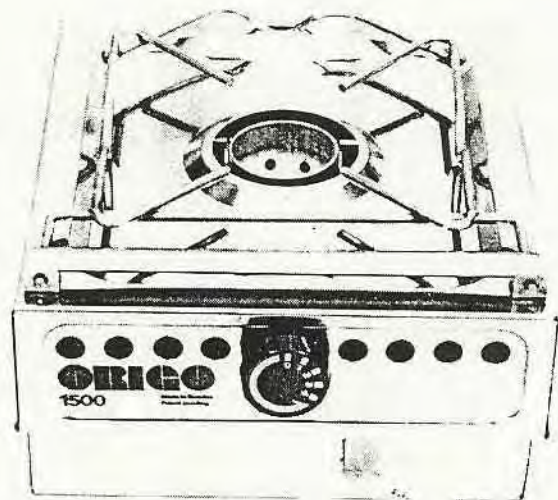

BRUKSANVISNING

INSTRUCTIONS

GEBRAUCHSANWEISUNG

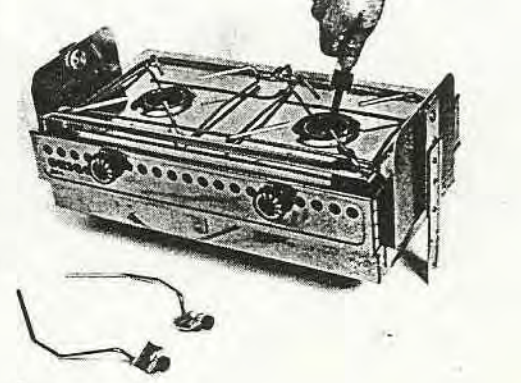
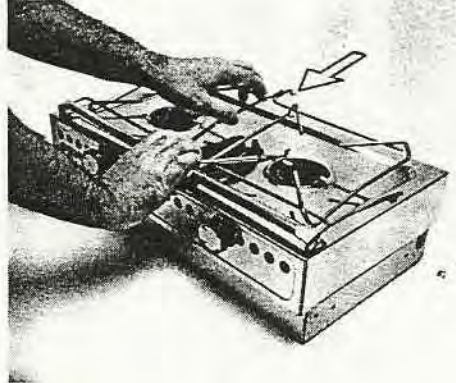
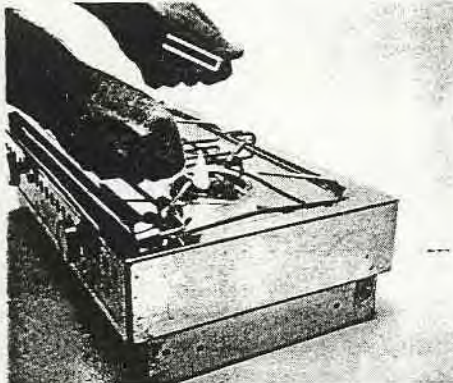
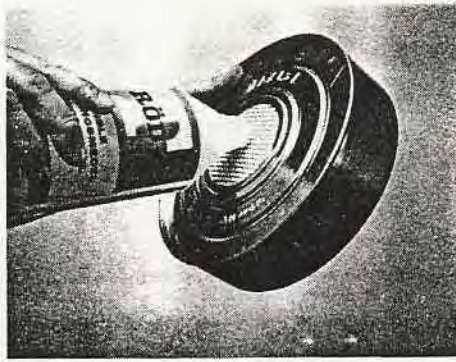
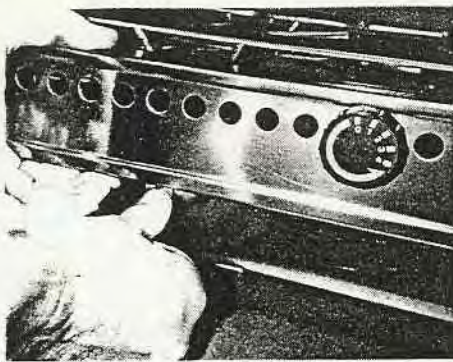

BRUKSANVISNING

ORIGO 1500 och 3000 är spritkök som arbetar utan övertryck och som har bränslet absorberat i en eldhärdig massa. De har dessutom gas känsliga ventiler eller andra delar som behöver regelbunden service. Detta gör köken mycket lättsköta och säkra.

Som alltid då man har att göra med öppen eld måste man naturligtvis iakttaga viss försiktighet. Läs därför noga igenom följande enkla anvisningar innan Ni använder Ert nya kök.

Om spritbrand trots allt någon gång skulle uppstå så kom ihåg att den kan släckas med vatten.

KÖKETS PLACERING

Köket skall endast användas i ett väl ventilerat utrymme. Man bör dock undvika alltför kraftigt drag eller blåst. Om det användes t.ex. i en öppen sittbrunn, bör man placera det så att bästa möjliga vindskydd erhålles. Placeringen bör även vara sådan att man får största möjliga avstånd till omgivande brännbara eller mindre värmetåliga material. Det bästa är om köket monteras i ett slätklätt utrymme.

PÅFYLLNING

Får ej ske i närheten av öppen eld eller heta föremål. Uppfällning av hällen: Rattarna i läge 0 så att behållaröppningarna är helt täckta. Hällens nedre framkant drages lätt framåt samtidigt som man trycker på spärren PRESS (enl. bild 1).

Lyft ur behållarna. Kontrollera att lågorna är helt släckta och att ingen glöd finns i behållaröppningarna. Då köket användes uppvärms behållarna, varvid spriten utvidgas och behöver visst expansionsutrymme. Det är därför nödvändigt att inte överfylla behållarna.

Behållaröppningarna har en försänkning vid kanten för att underlätta påfyllningen. Håll behållaren som bild 2 visar, med försänkningen nedåt, och håll spriten direkt mot öppningens nät. Påfylld mängd kontrolleras genom att behållaren hålls på högkant som på bild 3. Fyllningen kan ske tills spritytan blir synlig i försänkningen vid behållaröppningens nedre kant. Efter påfyllning — se bild 4 — gen utspild sprit finnes i köket. Torka alltid av behållarna.

Ställ ned behållarna — kontrollera att de passar in mellan styrningarna. Nedfällning av hällen: Rattarna i läge 0 som ovan. Hällen fälls ned så att spärren låser.

ÄNDRING (BILD 4)

Öppna brännaren med regleringsratten genom vridning åt vänster.

Stick ned en brinnande tändsticka i brännaröppningen. Tändstickan kan släppas ned i brännaren och tas bort vid nästa påfyllning.

Om brännaren tänder häftigt så att lågan blåses ut (kan inträffa om behållaren är ljummen) — håll en brinnande tändsticka i beredskap — blå kraftigt ned i brännaröppningen och tänd omedelbart. (Använd ev. braständsticka eller ORIGO's gaständare).

Om köket skall stå oanvänt en längre tid är det lämpligt att låta spriten brinna slut i behållarna.

SLÄCKNING

Vrid regleringsratten åt höger så långt det går.

DEMONTERING AV KOKKÄRLSSTÖD (BILD 5)

På hällens ovansida finns på bakkantens mitt ett avlångt hål. Om stödet vid denna punkt pressas mot kökets framsida kan det lyftas ur hålet och tas upp. Fäll och lyft sedan av det.

BALANSUPPHÄNGNING

Som extra tillbehör finns balansupphängning, som monteras på följande sätt:

Gavelplåtarna fästes vid kökets underdel med hjälp av medföljande skruvar och muttrar (se bild 6). De kan endast monteras på ett sätt. Upphångningsarmarna kan däremot vändas så att köket kan sänkas ned framåt eller bakåt. Innan Ni bestämmer hur armarna skall sitta så gör ett prov genom att montera fast dem vid gavelplåtarna och undersök vilket alternativ som passar bäst i Er båt. Tänk på att hällen skall kunna fällas upp vid påfyllning då köket är nedsänkt. Andra viktiga faktorer att taga hänsyn till är att köket i uppfällt läge får tillräcklig plats att pendla både framåt och bakåt. Var också, som tidigare nämnts, noga med att det inte hamnar för nära något mindre värmetåligt eller brännbart material.

När Ni slutgiltigt hänger upp köket genom att fästa gavelplåtarna vid upphångningsarmarnas axeltappar, är det viktigt att de olika detaljerna monteras i rätt ordning. De fiberbrickor som har runt hål skall sitta innerst på tapparna. Häng därefter upp köket. Trä på de brickor som har avlångt hål så att de passar i tapparnas avfräsningar och skruva till slut i spännskruvarna. Justera skruvarnas åtdragning så att önskad friktion erhålles.

Köket levereras med packningar för bränslebehållarna. Dessa kan användas om köket står oanvänt under en längre tid samt vid varm väderlek för att hindra spriten att avdunsta.

Gör så här: fäll upp hällen — kontrollera att köket svalnat. Lägg

TEKNISKA DATA:

Höjd: ca 137 mm (inkl. kokkärilstöd)
Bredd: ca 275 mm
Längd: ca 464 mm (1500, ca 236 mm)
Kapacitet: ca 1,2 liter per behållare
t: 1 liter vatten kokar på 6—8 min.
sle: T-sprit (T-röd)

INSTRUCTIONS

ORIGO 1500 and 3000 are non-pressurized alcohol stoves with the fuel absorbed in a non-flammable pulpe. They have no valves to develop leaks, or other components in need of regular service. This makes ORIGO 1500 and 3000 safe and easy to maintain.

As always — when working with a naked flame — certain precautions are required. So, read the following simple instructions carefully before using your new ORIGO 1500 and 3000 stove.

If an accident should ever occur, remember that burning alcohol can be extinguished with water.

LOCATION OF YOUR NEW ORIGO 1500 AND 3000

Your stove should be located in a well-ventilated space. Avoid excessive draft. If inst. your ORIGO 1500 and 3000 is used in an open cockpit, it should be placed so that maximum protection against the wind is obtained. Mount the stove as far away from combustible materials as possible. Preferably mount the stove in a metal-lined space.

TO FILL, OPEN THE STOVE TOP

Turn the knobs to 0 position, burner openings fully covered. Pull the forward lower edge of the stove top slightly forward, while simultaneously pressing the catch PRESS (photo 1).

Stove top must not be filled near an open flame or a hot object. The stove top can only be opened when the burner openings are completely covered by the regulating plates. Turn the regulator knobs clockwise as far as they go, and the flames are extinguished. Lift out tank unit. It is essential that not only has the flame been completely extinguished, but that there is no heat grow on burner top.

During use, the tanks are heated, and the fuel requires space to expand. It is therefore important to avoid overfilling the tanks.

The tank openings are recessed to facilitate filling. Hold the tank as shown in photo 2, with the recess pointing down, and pour the fuel directly into the opening covered by the wire mesh. Check quantity by raising to vertical. When fuel is visible in recess, do not fill more (photo 3). After filling, make certain no excess fuel remains in stove. Always wipe tanks dry. Place tanks in stove. Check that they fit properly in mountings. Close the stove up.

Closing: Knobs in 0 position! Fold down the stove top, the catch will lock. (Make certain that the regulating plates cover the burner openings so that stove top is level.)

TO LIGHT (PHOTO 4)

Turn regulator knob counter-clockwise to open burner. Place a lighted match at burner opening. (Match can be dropped in and removed at next filling.)

If the stove is warm (from previous use), burner may ignite suddenly and simultaneously snuff itself out. If this happens, blow down into burner opening to dissipate alcohol vapor, and relight. The Origo-lighter is recommended. Winterize your stove by burning remaining fuel.

EXTINGUISH

Turn regulator knob clockwise.

TO REMOVE GRID (PHOTO 5)

At the back of the stove top is an oblong hole, into which the grid retaining hook fits. To remove grid, slide it out of the retaining hole and it can be lifted off.

Balansupphängning
Kokkärilshållare
Gaständare

ORIGOVERKEN

Box 171
301 03 HALMSTAD

GIMBALS

Gimbals for ORIGO 1500 and 3000 are optional. Your ORIGO 1500 and 3000 gimbals should be mounted as follows: The gibal side-plates are fastened to the lower body of the stove by the enclosed nuts and bolts (see illustr. 6). They can only be attached in one way.

The gibal arms, however, can be turned to enable the stove to be lowered forwards or backwards. Before mounting the gibal arms, make a test by attaching them to the gibal plates in order to determine which alternative is right for your boat. Remember that the stove top must be raised to full upright position in order to remove burner units for filling, when the gimbals are in down position. Also be sure that your ORIGO 1500 and 3000 stove has sufficient room to swing freely when gimbals are used. Take care that stove is not mounted too close to combustible materials, or materials likely to deteriorate from the heat. When lifting the stove into position you fasten the gibal side plates to the gibal arms at the pivot point using the two special thumb screws supplied. Be sure that the installation is done in the correct sequence.

Fiber washers with round holes must be placed on the gibal arm side. Then hang stove. Place fiber washers with oblong hole between body of stove and gibal plate. They are cut to fit the end of the plate, and fasten the screws. Adjust the tension of the screws to the desired friction.

GASKETS

The stove is delivered with gaskets on top of the tanks. These are to be used if you are not using your stove for some time. Can also be used to prevent evaporation in hot climate.

Use this way: fold up the stovetop, check that the stove has become cold. Put the gaskets over the tank openings. Fold down the stovetop to horizontal position and open the burners to lock the top in closed position.

TECHNICAL DATA:

Height: approx. 5 3/8" (137 mm) incl. cooking grid
Depth: approx. 10 7/8 275 mm
Length: approx. 18 1/4 464 mm (1500, 9 5/16" 236 mm)
Fuel tanks: approx. 2.5 pints each tanks (1,2 l.)
Fuel: denatured alcohol, methylated spirit
Efficiency: will boil 2 pints of water in 7 minutes (per burner)

OPTIONAL EXTRAS

Gimbals
Potholders
Lighter

WARNING

To be used only with denatured alcohol. Must never be used with gasoline, kerosene, diesel or any other type of fuels.

ORIGOVERKEN

Box 171
S-301 03 HALMSTAD
SWEDEN

ORIGO USA INC.

1121 LEWIS AVE. — SARASOTA
FLORIDA 33577

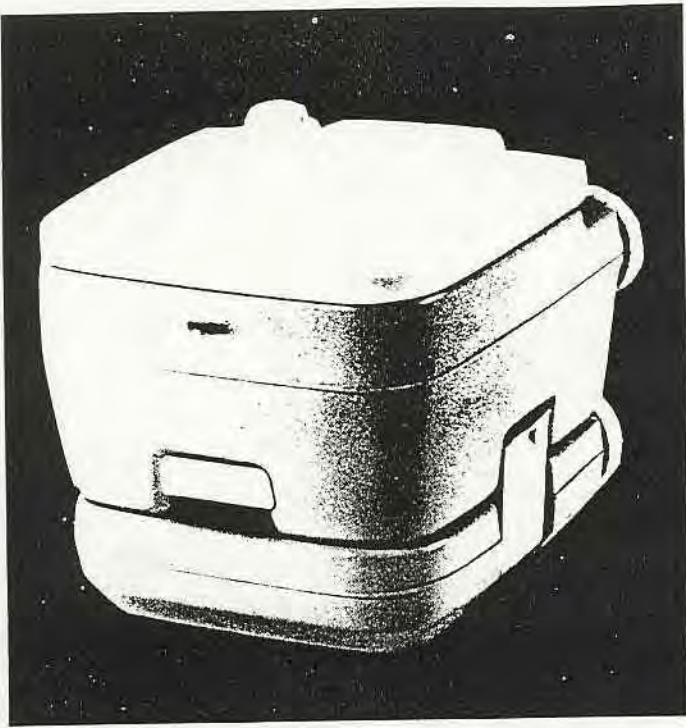

Mansfield[®] SaniPOTTIE[®] 943 & 944 Marine Portable Toilets

- At-home convenience, wherever you go.
- Compact, lightweight . . . crafted of corrosion-proof, heavy-duty polyethylene and styrene.
- Requires no external water or power source; operates on self-contained clean water supply; features gas-tight, odor-free valve seal.
- Simple to carry, operate and maintain.
- Available in two colors Parchment and Oxford — and all Parchment.
- Stainless steel hold-down brackets for secure mounting.

A few of the many SANI-POTTIE[®] features

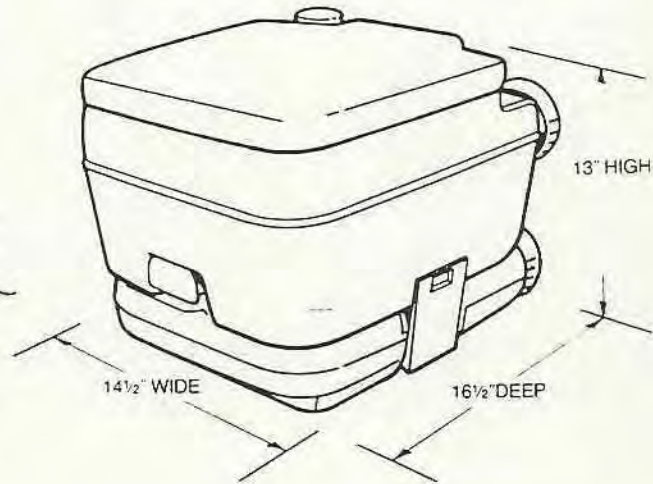
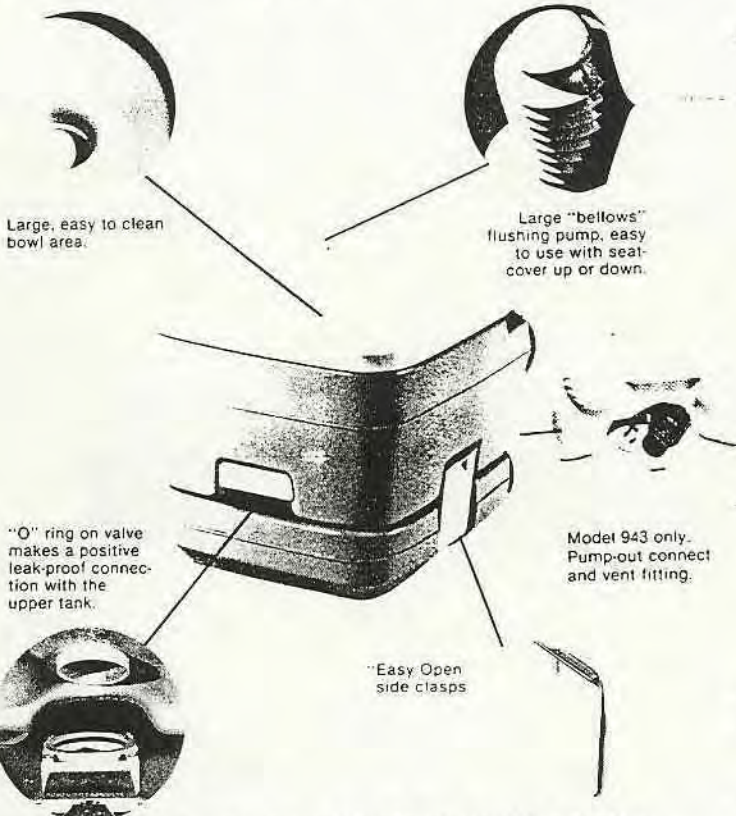

Use these specifications to order:

Order No.	Description	Approx. Wt.
943	SANI POTTIE Marine Portable Toilet. Complete with stainless steel hold-down brackets, pump-out connection and vent fitting.	15
944	SANI POTTIE Marine Portable Toilet. Complete with stainless steel hold-down brackets only.	14

NOTE: Portable toilets are legally acceptable for use in vessels not having permanently installed toilets, as determined by U.S. Coast Guard Regulations. However, some states and the Canadian province of Ontario do not permit portable toilets.

Mansfield Plumbing Products

BIG PRAIRIE, OHIO 44611 / TELEPHONE (216) 496-3211

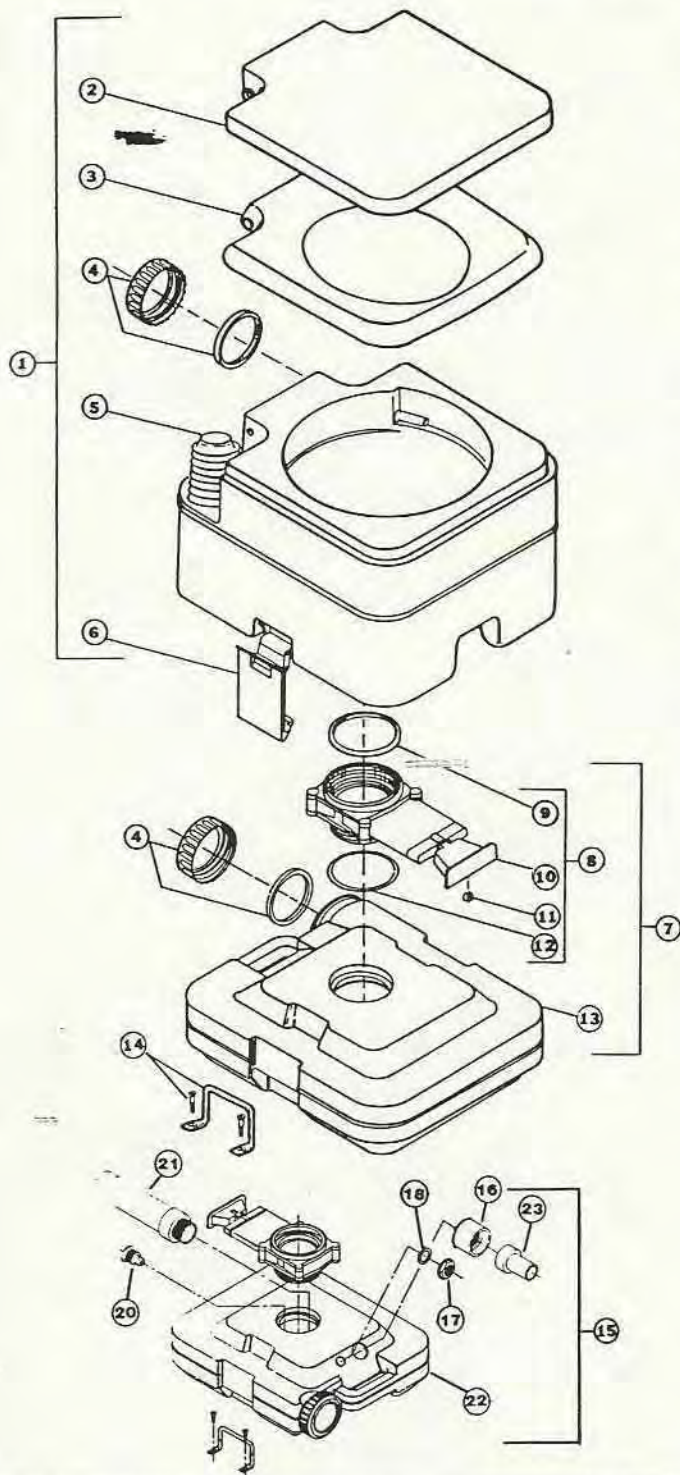

SANI-POTTIE®

Replacement Parts List

Item	Part No.	Description
1.	123-0173	Fresh Water Tk Assy. all PAR
	123-0172	Fresh Water Tk Assy. W/Oxford Seat
2.	312-0003	Cover, Seat OXF
	312-0013	Cover, Seat PAR
	645-0001	Hinge Pin OXF
	645-0012	Hinge Pin PAR
3.	747-0011	Seat, OXF
	747-0018	Seat, PAR
4.	531-0041	Kit, Cap & Seal OXF (2 Each)
	531-0050	Kit, Cap & Seal PAR (2 Each)
5.	531-0039	Kit, Bellows Pump PAR
6.	123-0116	Assy., Plastic Latch OXF
	123-0151	Assy., Plastic Latch PAR
7.	123-0167	944 Assy., Hldg Tank PAR
	123-0168	944 Assy., Hldg Tank OXF
8.	123-0177	Assy., Slide Valve OXF W/O-Rings
	123-0187	Assy., Slide Valve PAR W/O-Rings
9.	612-6549	Top O-Ring
10.	468-0010	Handle OXF
	468-0015	Handle PAR
11.	273-6911	Handle Clip
12.	612-6401	Bottom O-Ring
13.	864-0013	Holding Tank Only OXF (944)
	864-9001	Holding Tank Only PAR (944)
14.	531-0018	Kit, Hold Down Brkt.
943 Holding Tank Assy.		
15.	123-0112	Assy., Holding Tank PAR
	123-0118	Assy., Holding Tank OXF
	123-0169	Assy., Holding Tank/SL VLV PAR
	123-0170	Assy., Holding Tank/SL VLV OXF
16.	123-0162	Assy., Outlet Adapter
17.	582-7068	Locknut
18.	447-1583	Fiber Gasket
19.	687-6606	Sealant 2" (not shown)
20.	420-0001	Fitting
21.	123-0076	Dip Tube
22.	864-0008	Holding Tank Only PAR
	864-0016	Holding Tank Only OXF
23.	105-0013	1-1/2" Hose Adapter

Chemical and Tissue

261-0004	Waste Be Gone Powder Chemical — 6-2 oz. PKS
261-0006	Waste Be Gone Liquid Chemical — 1-12 oz. BOT
639-8634	Sani-Soft — 4 Pack Tissue



Mansfield Plumbing Products

BIG PRAIRIE, OHIO 44611 / TELEPHONE (216) 496-3211

PROTECTING YOUR RIGGING

No matter how good your rigging is, without careful inspection and proper maintenance it is subject to fatigue, wear, discoloration, and, therefore, product failure. Remembering to inspect and clean will increase the life of your investment and secure your rigging. We would like to suggest the following:

■ Always rinse your rigging with fresh water after sailing. Especially after saltwater sailing. Salt can create corrosion pits, causing cracks and deterioration. In these severe corrosion conditions we recommend using high corrosion resistant alloy type 316.

■ Clean with a water soluble detergent *without* chlorine. Non-abrasive cleansers are best for hard white vinyl coated cables.

■ Store wrapped rigging with twine. *Never* use tape. Tape causes moisture, attracts dirt, and leaves residue that creates corrosion.

■ Inspect rigging for stains. Rust stains may indicate stress cracks or corrosion. Remove stains with synthetic or brass pads. *Never* use steel wool pads.

■ Look for broken wires - a sign of fatigue in rigging. Replace standing rigging if wires are broken.

■ *Never* mix stainless steel and galvanized metals on cable, fittings, pins, cotter keys, etc. If mixing dissimilar metals, electric currents may conduct between metal causing rapid deterioration.

■ After un-stepping, make sure to release all standing rigging to avoid bending, crushing, and kinking.

■ Store rigging in a dry place. *Never* store in a plastic bag. Plastic, like tape, causes corrosion.

MANUFACTURED BY:

**Carolina
Steel & Wire**
CORPORATION

**Carolina
Steel & Wire**
CORPORATION



D I S T R I B U T E D B Y :



SECO SOUTH

P.O. Box 1158, Largo, Florida 34649-1158
Telephone (813) 536-1924. FAX (813) 539-6314.
2050 34th Way, Largo, Florida 34641.

S T A I N L E S S S T E E L
S T R A N D A N D C A B L E
F O R M A R I N E U S E S

HULL SPEEDS

Best Expected

22	5.5 <i>Knots</i>
23	5.75
25.5	6
28.5	6.25
31	6.5
34	6.75
37 Old	7
37 New	7.25
40	7.5
45	8.0

STEP 1:

You will start off by raising the boom crutch to its highest position. Then walk the mast aft with the main-sail track down until the base of the mast lines up with the mast step. Position the mast correctly in the step and have the crew member designated push the pin through the aft hole connecting the two parts at the step to form a hinge.

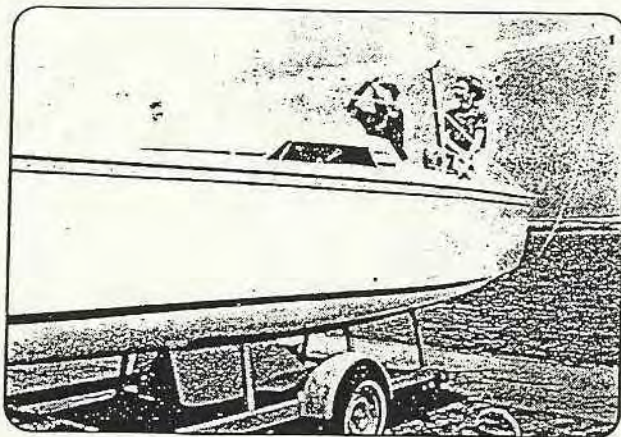

Loosen all turnbuckles until there are four (4) full turns on each end and then attach the uppers, lowers and the backstay to the appropriate chainplates. Attach a swivel block, not included, to the mooring pin in the bow. Tie the jib sheet to the forestay turnbuckle with a bowline and lead the sheet through the swivel block and aft to one of the jib sheet winches.

You are now ready to raise the mast. (We suggest that you double-check these procedures one more time before going to step two.)

STEP 2:

The strongest of the crew members will be the one to raise the mast as far as possible while standing in the cockpit at the forward end while another crew member puts tension on the line attached to the headstay by cranking the jib sheet winch with the winch handle. Tighten this line as tight as you can.

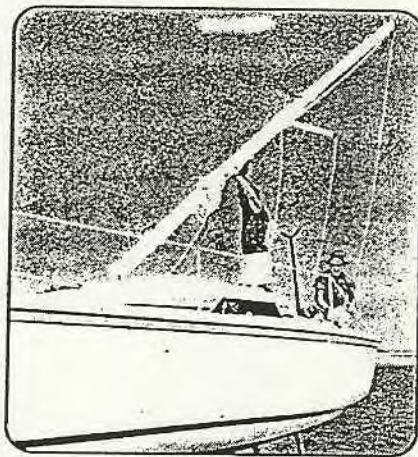

STEP 3:

After making sure that the headstay line is fully supporting the mast and is now securely cleated, the crew members change positions; the crew member at the winch takes the place of the crew member at the mast and *vice versa*.

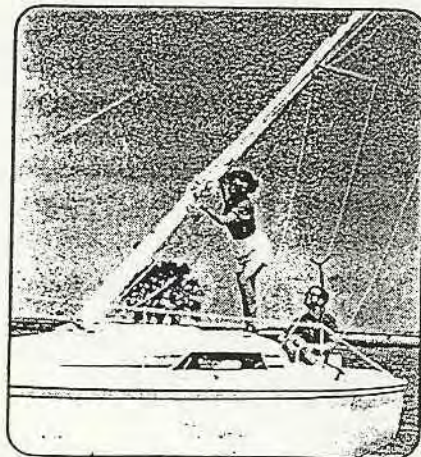

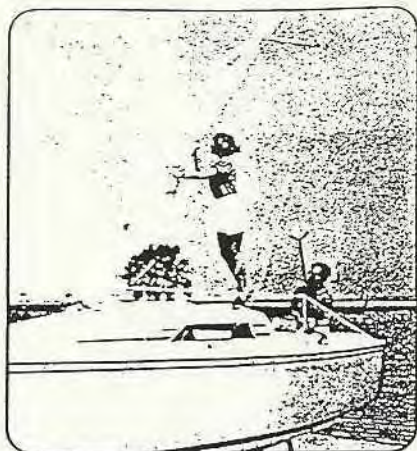

STEP 4:

The mast continues to be raised by a joint effort of cranking the winch while at the same time hoisting/guiding the mast easily, as the headstay line will carry the bulk of the weight. Team effort here pays off. Be sure it doesn't lean from side to side; keep it straight as it goes up.

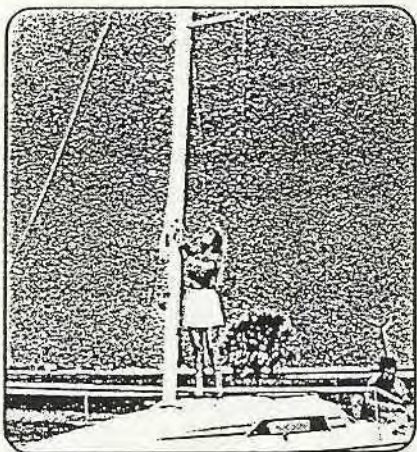

STEP 5:

The crew member guiding the mast upward holds it in the upright position while the crew member at the winch goes forward. Disconnect the headstay line and attach the headstay to the chainplate.

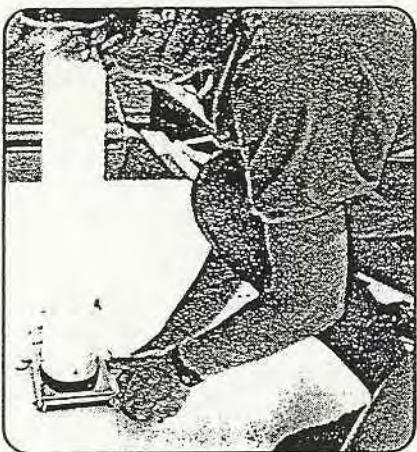

STEP 6:

All you need to do now is insert the forward pin through the holes at the mast step, thereby securing the mast to the mast step and deck. The other crew member continues to hold the mast steady during this final procedure.

STEP 7:

Now all you have left to do is tighten and tune the rigging, attach the sails and give your Hunter 23 the "once over" before backing the trailer into the water and setting out to sea. Make sure all your gear is properly stowed, your car is locked and you have the keys, and then you're ready for any adventure awaiting you and your crew.

HUNTER 23 MOTOR:

The Hunter 23 outboard motor should be operated in accordance with the instructions provided by the manufacturer.

As a precaution to insure that you do not lose the outboard if the clamp comes loose, *always have a safety line attached from the motor to the boat.*

HUNTER 23 TRAILER:

It is recommended that you maintain your trailer weight at approximately 225 pounds.

HUNTER



TUNING THE RIGGING:

MAST TUNING INSTRUCTIONS:

Attach stays and shrouds.

After raising your mast, attach the headstay, backstay, upper shrouds and lower shrouds. Set the headstay turnbuckle at 1/2 open and then tighten backstay turnbuckle to medium tension.

To center mast athwartships, start with only slight tension on the upper and lower shrouds. Check to see if the mast is centered in the boat by measuring from the masthead to the chainplates with a steel tape measure hoisted completely up the main halyard. Adjust the upper shroud until the measurements port and starboard are exactly the same. Now the spar is plumb athwartships, tension both uppers equally, counting turnbuckle revolutions as you go. Tighten uppers until you have approximately 1" of "prebend" fore and aft in the mast. This is achieved because the swept spreaders will push the middle part of the mast forward as you increase tension of the uppers.

Now tighten the lower shrouds evenly making sure the mast remains straight athwartship. Sight up the luff groove to assure this straightness. Lowers should end up almost as tight as the uppers. Tighten backstay to a taut position. Perhaps 8-10 turns past your original tension.

Check the mast tuning by sailing in medium winds (10-12 knots). Sometimes fine tuning of the upper and lower shrouds is necessary when the spar is loaded in sailing conditions. Sail on both tacks, sighting up the luff groove to check athwartship straightness. Both upper and lower

shrouds should not be loose on the leeward side.

When mast tuning is complete, install cotter pins in all turnbuckles and tape over sharp edges of the cotter pins with chafe tape.

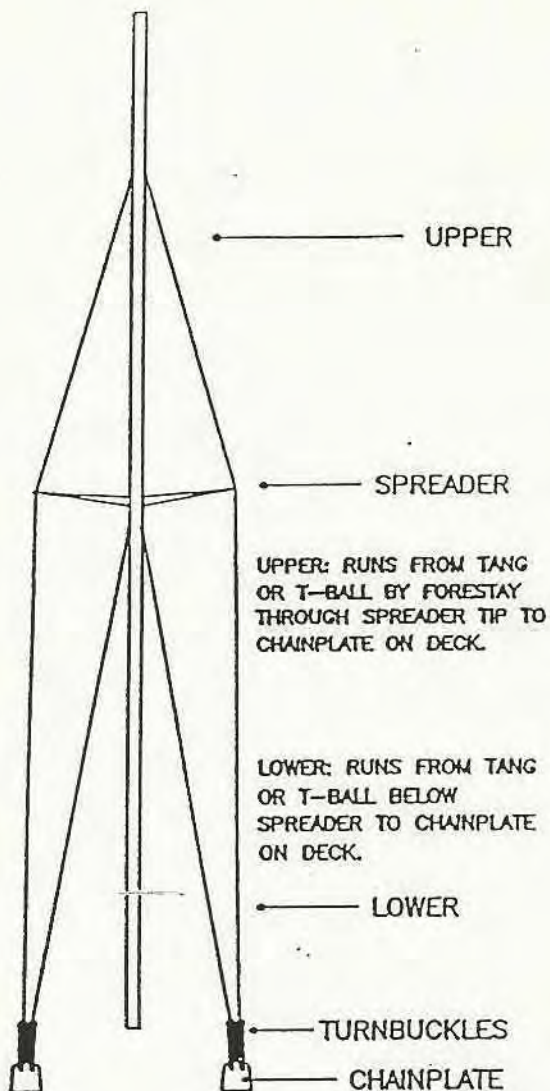

BACKSTAY: RUNS FROM MASTHEAD TO BACKSTAY-CHAINPLATE ON DECK.

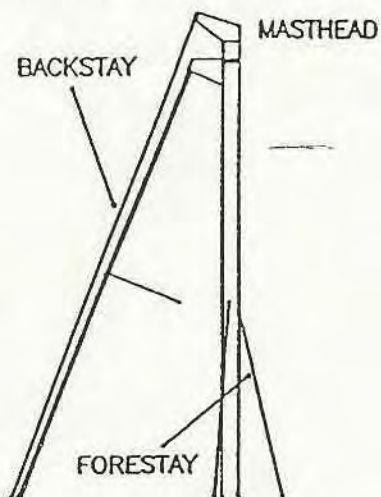



FORESTAY RUNS FROM A POINT APPROXIMATELY 20% BELOW MASTHEAD TO STEMHEAD FITTING.

HUNTER 

SINGLE SPREADER FRACTIONAL RIG W/ SWEPT BACK SPREADERS GEN2600A

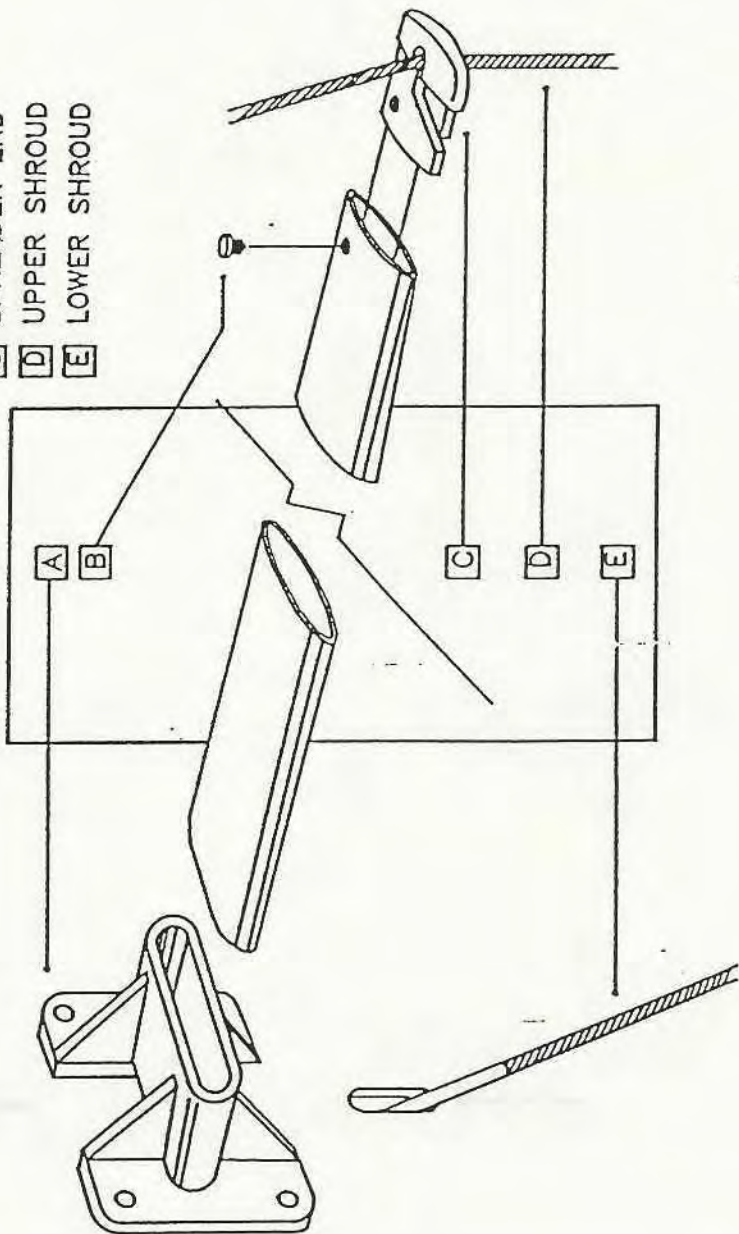
- A** BRACKET
- B** SET SCREW
- C** SPREADER END
- D** UPPER SHROUD
- E** LOWER SHROUD



HUNTER  H18 Z-SPAR SPREADER DETAIL

FROM EXIT ON MAST

JIB HALYARD: EXITS MAST
AND WRAPS CLOCKWISE
AROUND WINCH.

MAIN HALYARD: EXITS FROM
BOTTOM OF MAST AND
WRAPS COUNTER-CLOCKWISE
AROUND MAST.

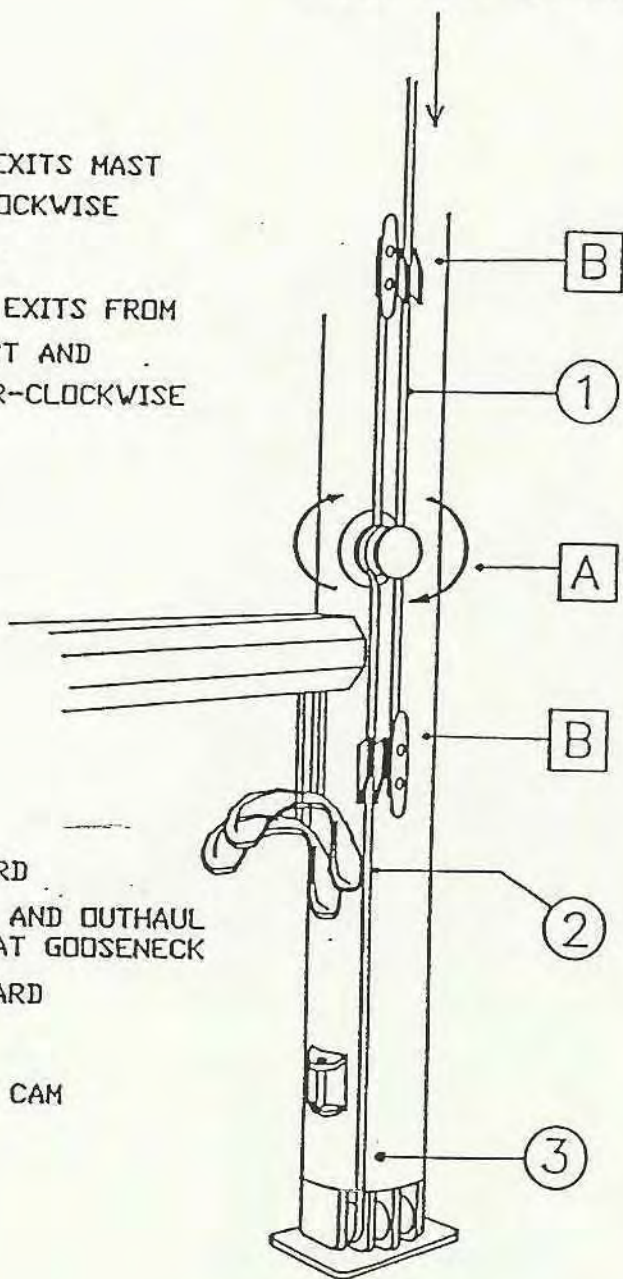

- ① JIB HALYARD
- ② REEF LINE AND OUTHAUL
TIED OFF AT GOOSENECK
- ③ MAIN HALYARD
- A WINCH
- B CLEAT AND CAM

III. Sails & Rigging

A. Tuning the Conventional Fractional Rig (Hunter 23, Hunter 26.5, Hunter 333, Legend 35, Legend 37)

TUNING THE RIGGING:

After raising your mast, attach the headstay, backstay, upper shrouds and lower shrouds. Set the headstay turnbuckle at half open and then tighten backstay turnbuckle to medium tension.

To center the mast athwartships, start with only slight tension on the upper and lower shrouds. Check that the mast is centered in the boat by measuring

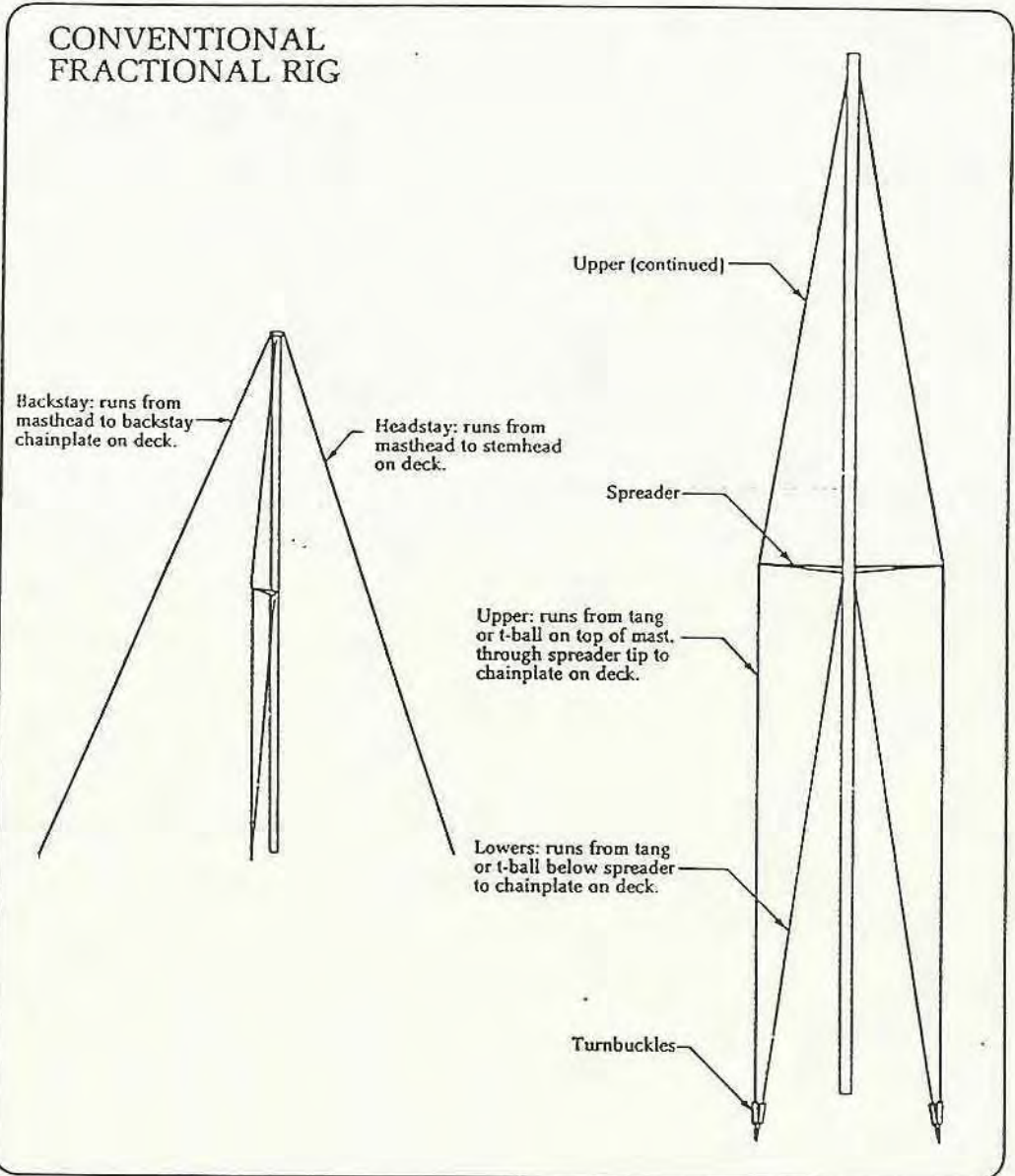

from the masthead to the chainplates with a steel tape measure hoisted completely up the main halyard. Adjust the upper shroud until the measurements port and starboard are exactly the same. Now the spar is plumb athwartships, tension both uppers equally, counting turnbuckle revolutions as you go. Tighten uppers until you have approximately one inch of "prebend" fore and aft in the mast. This is achieved because the swept spreaders will push the middle part of the mast forward as you increase tension of the uppers.

Now tighten the lower shrouds evenly, making sure the mast remains straight athwartship. Sight up the luff groove to assure this straightness. Lower should end up almost as tight as the uppers. (The uppers should always be the tightest.) Both the Legend 35 and Legend 37 are equipped with double spreaders. The three shrouds should be made progressively tighter toward the top of the rig; the uppers should be the tightest of all. Tighten backstay to a taut position: perhaps eight to ten turns past your original tension.

Check the mast tuning by sailing in medium winds (10-12 knots). Sometimes fine tuning the upper and lower shrouds is necessary when the spar is loaded in sailing conditions. Sail on both tacks, sighting up the luff groove to check athwartship straightness. Both upper and lower shrouds should be taut on the leeward side.

When mast tuning is complete, install cotter pins in all turnbuckles and tape over sharp edges of the cotter pins with chafe tape.

┌ Tuning the B&R Rig (Hunter 28.5, Legend 40, Legend 45)

NOMENCLATURE DESIGNATION:

upper-upper	D3*
lower-upper	V2
lower-intermediate	V1
lower	D1
upper-intermediate	D2*
lower-diamond	d1
upper-diamond	d2

*D2 and D3 are cut to a fixed length (no turnbuckles).

Initial tuning is best accomplished before the mast is stepped.

Support the mast, forward side down, about one-quarter of its length from the end and at its center. Once the mast is supported, make certain that it has no bow in any direction. Attach a small string from the masthead, in line with the sail track groove, to the base of the mast, stretching it as tight as possible. Check to make sure it is a constant distance from the mast along the entire length.

You are now ready to "tune in" the desired mast bend, which is one percent of the mast height above the boom (.01 × mast height above boom). On a 50' mast, this would be .5 feet at the mid-point of the mast.

Using the rigging diagram, locate d1 and d2. Before tuning, make sure the turnbuckles are adjusted back with equal thread showing. Carefully counting turns, adjust d1 port, d1 starboard, d2 port and d2 starboard evenly until the desired bend is induced. This is checked by measuring from the string down to the mast at the center of the mast.

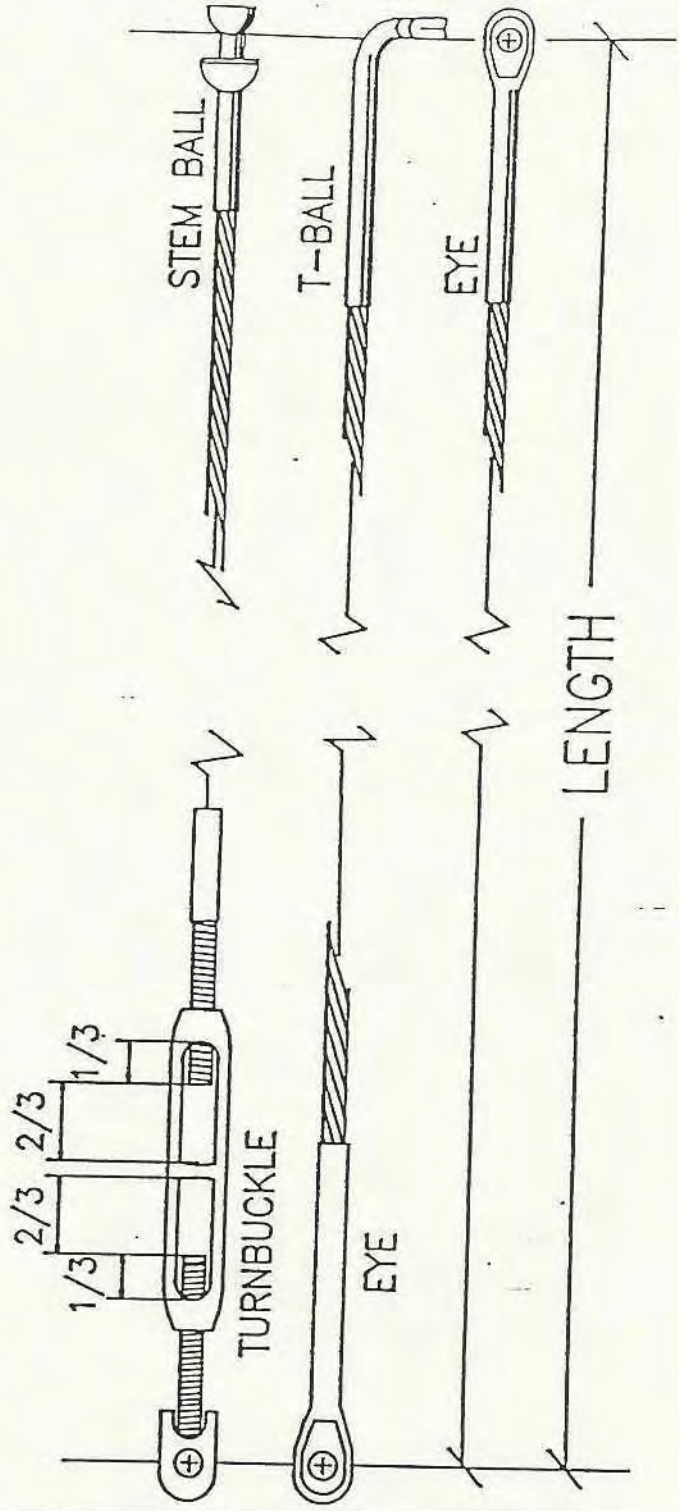

It is important to make sure the mast is straight athwartships at this time.

You are now ready to step the mast.

Step the mast with all shrouds loosely attached.

Adjust the forestay and backstay to obtain the desired mast rake. The mast should be vertical or raked aft. The more rake, the greater the weather helm. The forestay and backstay should have a reasonable amount of tension on them.

Adjust V2 (port and starboard) evenly until they are tight. You should finish with approximately equal amounts of thread showing on each turnbuckle.

Using the jib halyard, check the mast for athwartship plumb. Pull the halyard out to the side of the boat and below the shear. Repeat the procedure on the opposite side. If you find a big difference (more than 1/2 inch), adjust turnbuckles an equal amount in opposite directions until the mast is straight.

Adjust V1 (port and starboard) using the above procedure.

Repeat the procedure for D1 (port and starboard).

Your mast should now have the original "pre-bend" and be straight athwartship.

Check the mast tuning by sailing in medium winds (10 to 12 knots). Sail on both tacks, sighting up the luff groove to check athwartship straightness. Shrouds should not be loose on the leeward side. (This is especially important with the B&R rig.) Follow the progressive shroud tightness routine described in the tuning instructions for the conventional rig. When mast tuning is complete, install cotter pins in all turnbuckles and tape over sharp edges of the cotter pins with chafe tape.

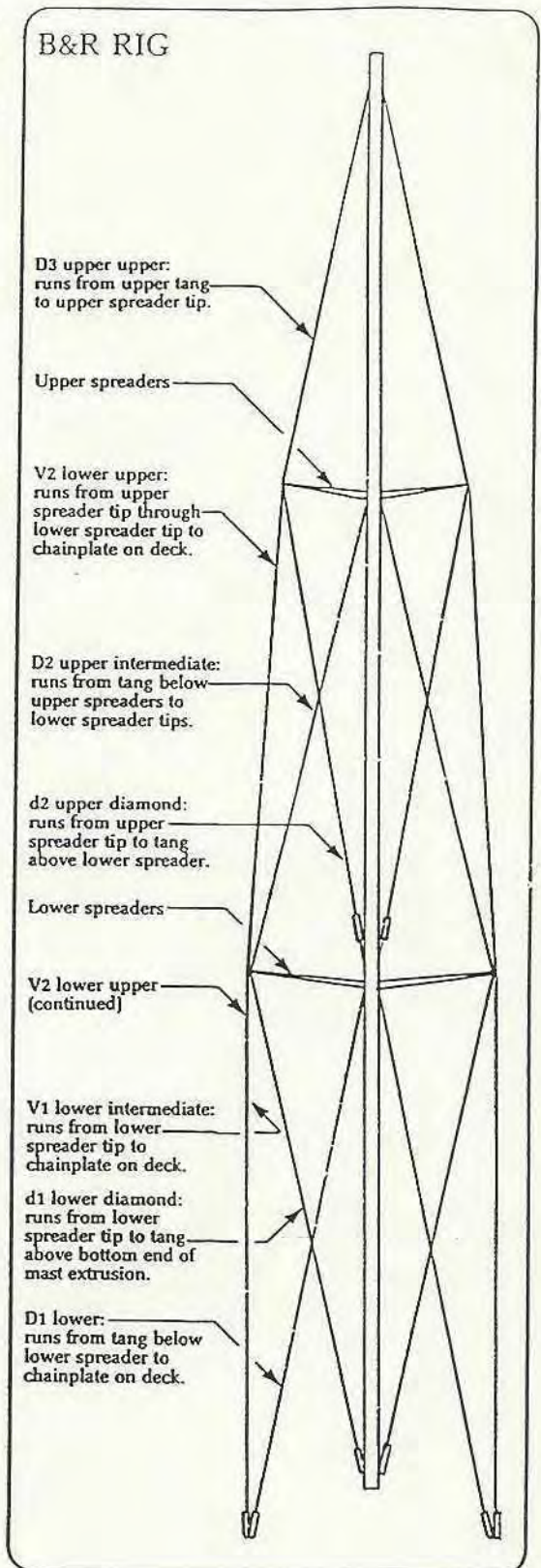

C. Roller Furling

OPERATING THE ROLLER FURLING:

1. To furl the sail, release the jib sheet and pull in on furling line from cockpit. Hand power is all that's needed; only special situations necessitate using a winch.
2. To roll the jib tightly around the headstay, it is advisable to keep some tension on the jib sheet. This can be done by holding the jib sheet and allowing it to slide through your fingers or by leaving two turns around a winch while furling. After jib has been completely furled, furling line should be cleated and jib sheet tensioned.
3. To unfurl, uncleat furling line, leaving one turn around the cleat for friction. This prevents snags on the drum. The jib sheet on leeward side of boat is then pulled to unfurl sail. It may be unrolled part-way or all the way, depending on wind conditions.

REEFING THE ROLLER FURLING SAIL:

1. The sail should be tightly rolled to maintain optimum sail shape. Leave two turns around the sheet winch with the tail of the jib sheet held loosely in your hand. Then pull the furling line in against tension of jib sheet to achieve the tightest roll (and, therefore, the best sail shape).
2. You may reef the sail to any point. Most any sail may be reefed except a large genoa which is specifically cut very full and has a lightweight cloth that cannot withstand the strain of reefing. (Consult a sailmaker if in doubt.)

D. Reefing the Mainsail

Your Hunter or Legend is equipped with an easy-to-use jiffy reefing system.

To reef the main:

1. Ease the mainsheet (boom vang if installed), making sure topping lift is secured in position.
2. Lower the main halyard so that tack reef cringle can be placed on gooseneck reef hook. Re-tension main halyard when hooked in place.
3. Clew reef line must now be tensioned so that clew reef cringle is brought down snugly against boom.
4. Readjust mainsheet and boom vang.
5. The reefed folds of cloth can be rolled up and secured with short lines through the reef points and around the folds and boom. **IMPORTANT:** Be sure to untie these first when shaking out the reef.
6. To unreef, reverse the procedure.

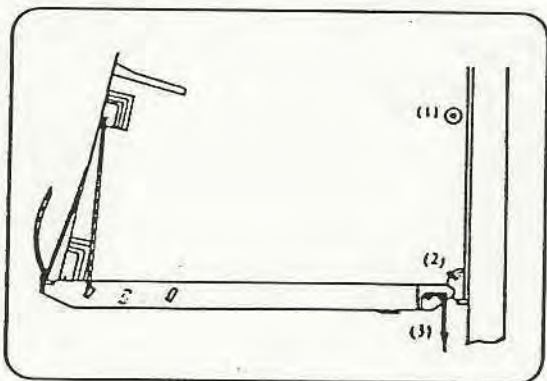

E. Sail Care and Storage

Your Hunter or Legend comes with Dacron mainsail and 110% genoa jib. To extend the life of your sails and maintain their best performance:

1. Never use them in wind ranges that exceed their capabilities.
2. Never let them luff for extended periods of time.
3. Rinse your sails in freshwater whenever possible if you sail in saltwater. Tub wash them every few seasons to keep them bright and attractive. **CAUTION:** Do not machine wash. Use a mild detergent in warm water, and *remove all detergents completely with a thorough rinsing.*

For oil and grease stains, use commercial cleaning solvents. Should a yellow stain develop, bleach with oxalic acid and rinse thoroughly. Rust stains should be soaked in a warm solution of two parts hydrochloric acid per 100 parts water, rinsing thoroughly.

After rinsing your sails, spread them and allow to dry thoroughly before bagging. This is a good time to inspect them for minor damage. When dry, fold according to diagram. First spread sail on flat surface, then fold in a smooth, accordion pleat from the foot to the head. Next, roll the folded sail from the tack to the clew and slide carefully into bag.

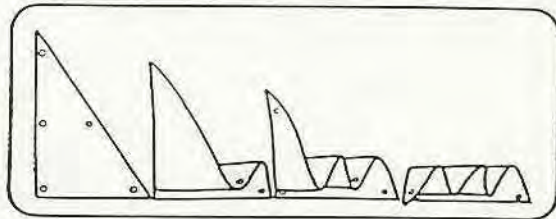

At the end of each season, it is good practice to have your local sailmaker inspect your sails for signs of wear and tear.

F. Care of Standing Rigging

The stays and shrouds on your Hunter or Legend are highly durable stainless steel to insure years of reliable service. To protect your standing rigging, keep it clean and, whenever possible, rinse thoroughly with freshwater. Check occasionally for "fish hooks," strands of wire that have broken and curled outward. These can snag sails and inflict painful cuts in bare hands. Broken strands indicate the wire is deteriorating and should be replaced.

Also inspect turnbuckles regularly and replace any missing cotter pins. Occasional lubricating improves both the life and the function of the turnbuckles.

G. Care of Running Rigging

To protect your running rigging (sheets, halyards) from damage, wash with cold water (and a mild detergent, if necessary), especially after exposure to saltwater. Rinse thoroughly and coil. Hang the tail ends of halyards off the deck to promote drying. Sheets should also be hung to dry.

Inspect all lines periodically for fraying and other damage. Lines showing substantial wear should be replaced.

H. Stepping the Mast On the Hunter 23

Hunter Marine recommends that you walk through the following seven steps and assign each person their respective task and positions during the stepping of the mast. Sailing is a fun and safe sport when the crew operates as a team. Good luck and smooth sailing.



Specifications:

L.O.A.	22'3"	6.78m.
L.W.L.	18'4"	5.59m.
Beam	7'11"	2.53m.
Draft:		
Fixed keel	3'2"	.97m.
Board up	23"	.58m.
Board down	5'0"	1.52m.
Displacement		
Fixed keel	3400 lbs.	1543.6 kg.
Swing keel	3200 lbs.	1452.8 kg.
Ballast (swing keel internal ballast)	1300 lbs.	590.2 kg.
Fixed keel	1400 lbs.	635.6 kg.
Mast height	26'0"	7.92m.
From waterline	30'3"	9.22m.
Sail area	220 sq.ft.	20.43 sq.m.
E (Mainsail foot)	8'4"	2.54m.
J (Foretriangle base)	9'0"	2.74m.
P (Mainsail luff)	23'6"	7.16m.
I (Foretriangle ht.)	27'0"	8.23m.



Space, Comfort and Standard Equipment Make Our 22 Number One in its Class.

You simply won't find more room, more amenities, more equipment, or more sailing style on any 22.

Our Design Group's pioneering approach has produced an unusually spacious boat that's a genuine pleasure to sail. And it boasts features rarely found even on larger boats.

The beam is nearly eight feet across, allowing space for a number of exceptional features: A complete galley with stove, sink, and removable icebox; a dropleaf dinette table; and a V-berth and two quarter berths.

There's more stowage than you'd expect, too, including a unique "sea bag" system in the V-berth area where items can be stowed in separate pouches attached to the cabin sides, or removed for transporting.

A top-of-the-line portable head rounds out the interior amenities.

The cockpit gives you the same big-boat feeling. Comfortable, secure seating, a large locker portside and a self-ventilated fuel locker under the starboard seat. There's ever

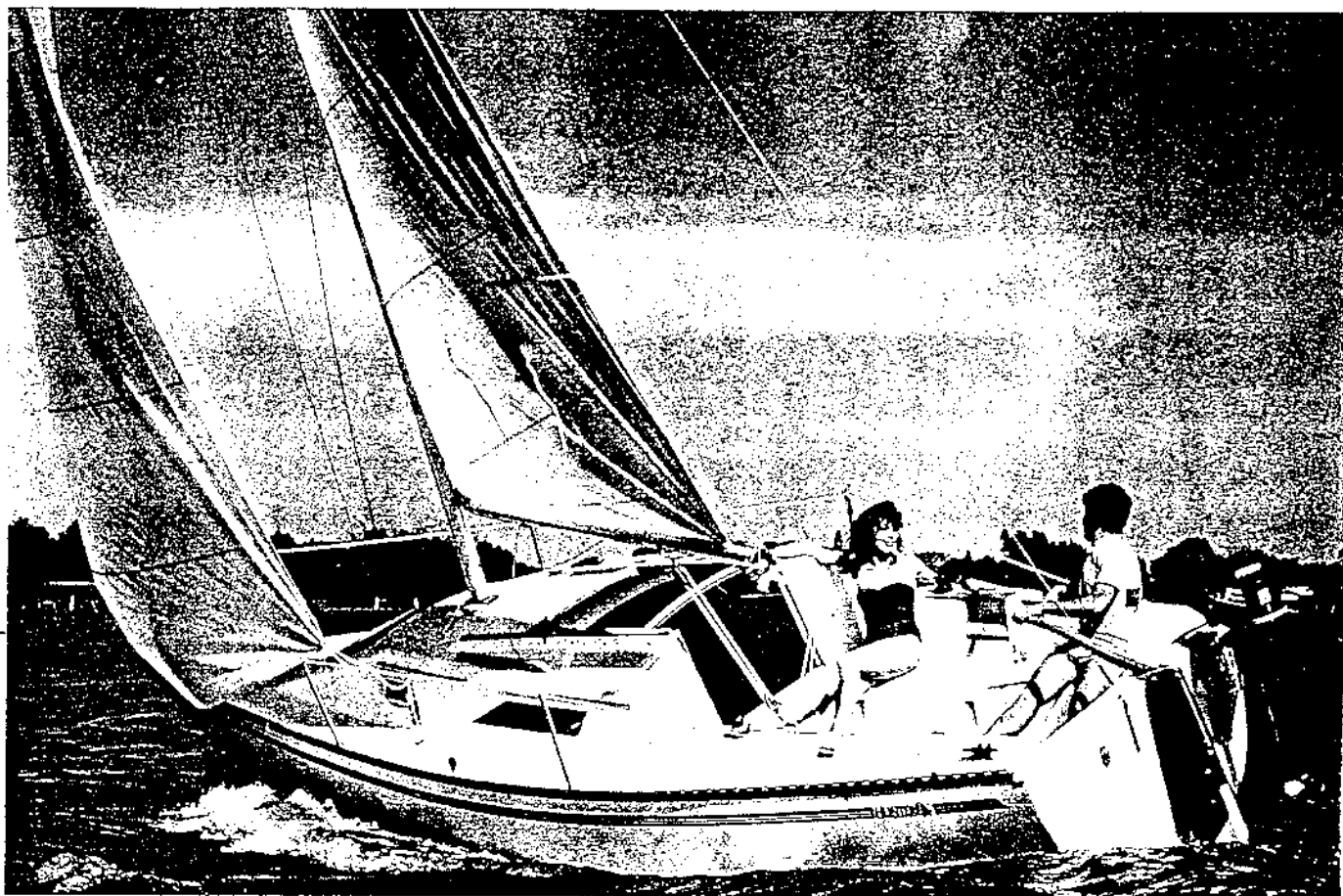

DOING THE TEST OF THE HUNTER 22 opened big doors in my mind. It seemed impossible to disassociate the boat from the bigger picture, of which this 22-footer was but a part. You'll know what I'm talking about when I refer to the Hunter 22, not as just another sailboat — a relatively small sailboat, in a low price range — but as a *small cruiser*. Changes the picture, doesn't it? And well it might. Because as you come with me to evaluate this clever small cruiser — and it is that — you'll see that quite possibly what we are really doing is examining a way of life.

I consider a small cruiser as anything from 22 feet down to maybe 17 feet. The small cruiser, like its larger cousins, must obviously have good sleeping accommodations below decks, plus a galley, and a head. It's assumed that it has good sailing characteristics, an adequate cockpit, some sort of auxiliary power and — you name them — all the other amenities, like ample stowage, dinette, and the rest of it.

But there is so much, much more that the small cruiser has — and the larger cruiser doesn't have! That the larger cruiser could never have!

First, the small cruiser is trailerable. This is a big plus. The small

HUNTER 22



One of the best uses of space yet seen on a sailboat this size

By Dave Kitz

cruiser can go virtually anywhere, at minimal cost, at any time of the year. In the large cruiser you're talking time — lots of time.

Secondly, the small cruiser, because of its size, is more flexible. This means out-of-the-way docks and anchorages. It means shallow draft, and limitless possibilities for gunkholing. Running aground? A very minor problem, usually of no consequence.

Thirdly, and I think most important, is simplicity. That is, not having to worry about sophisticated equipment, multiple through-hulls, and fancy gear that could interfere with safety rather than promote it.

I'm sure you are beginning to get the picture. And I haven't even mentioned original cost, maintenance, storage, and just plain having fun. So now the Hunter 22 is not just another small sailboat. It's possibly the biggest small cruiser money will buy!

A proud owner, Charles Eldredge of Miami, Florida, lent me his boat for the test. He was along to help out, and so was his son, Charley, and without them I don't mind telling you I would have had a time navigating the four bridges we had pass under. Two of them opened up for us, and two of them we cleared by inches. The Sunday afternoon traffic was awesome, and the 9.9 Evinrude auxiliary performed indefatigably in the pinches.

Once out in Biscayne Bay's sparkling broadness, the Hunter got right down to business. We had up the full main and full 110 percent roller furling genoa, and in the 13 to 15-knot breeze she really hustled. And was fun to sail. Designer Cort Streck states the 22 was designed with minimum wetted surface. This means you don't have to pile on the canvas to make her go. She is easily powered, in fact, and is designed to sail upright.

How to combine clean lines with volume in 22 feet. Top to bottom: A sizeable cockpit; bulkhead separates vee berths with stowage bags from main cabin with folding dinette over centerboard trunk; companion step converts to galley space.

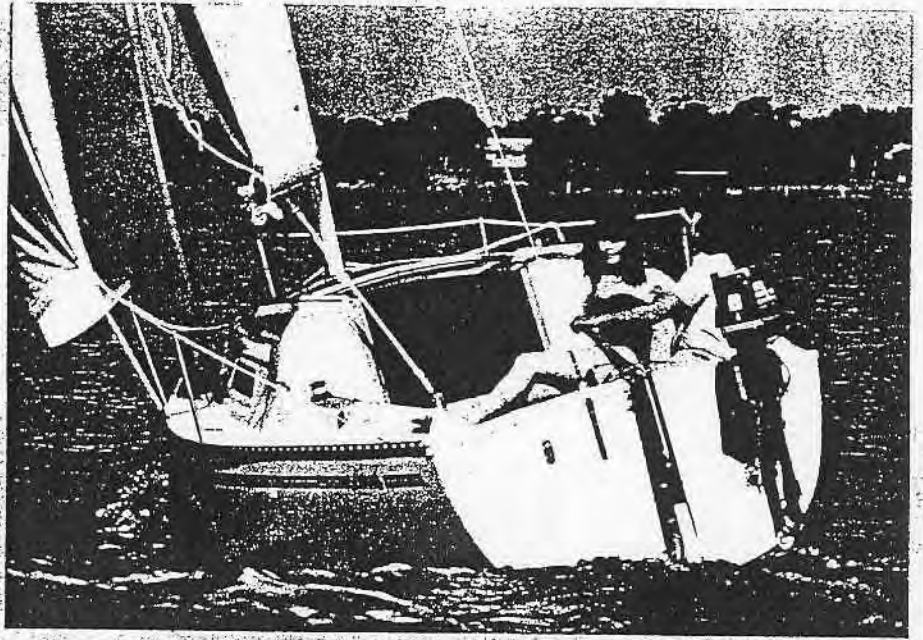

With everything strapped in, I felt the weather helm to be a little hefty, and on a couple of occasions the boat rounded up on me. The Hunter is a centerboarder, but with 1300 pounds of internal lead ballast under her teak and holly cabin sole, I was satisfied she would be stiff enough in heavier winds. I could minimize the weatherliness by reefing, and with the genoa rolled up a tad, we sailed more comfortably in the groove. With no effort we notched out a tacking angle of 80 degrees.

The rudder on the Hunter 22 is a novel arrangement. If it strikes anything it will float right up, and to get it back down, you simply pull up on a lanyard, and presto! Down goes the rudder again. Sounds foolproof, and I thought it to be one of the best arrangements I had ever seen, but talking later to Streck, I learned that the line could stretch and that the rudder might sneak up an inch or two. When this happens, the load on the rudder is moved farther aft, and it introduces substantial weather helm. Some owners drill a hole and put in a dowel, which will break off in the event the boat runs aground.

Reaching, the Hunter was sensitive and docile, and with everything drawing she scooted right along. Checking speed against larger boats cruising in our area, the Hunter seemed quick. It was easy to picture her moving smartly along some shoreline in the Great Lakes.

The cockpit on the Hunter felt secure and comfortable. The seats were wide, with good back support, and the stowage beneath the cockpit seats left nothing to be desired. There was deep storage on the port side; and plenty of room for fuel, miscellaneous gear, and table legs for a cockpit table un-

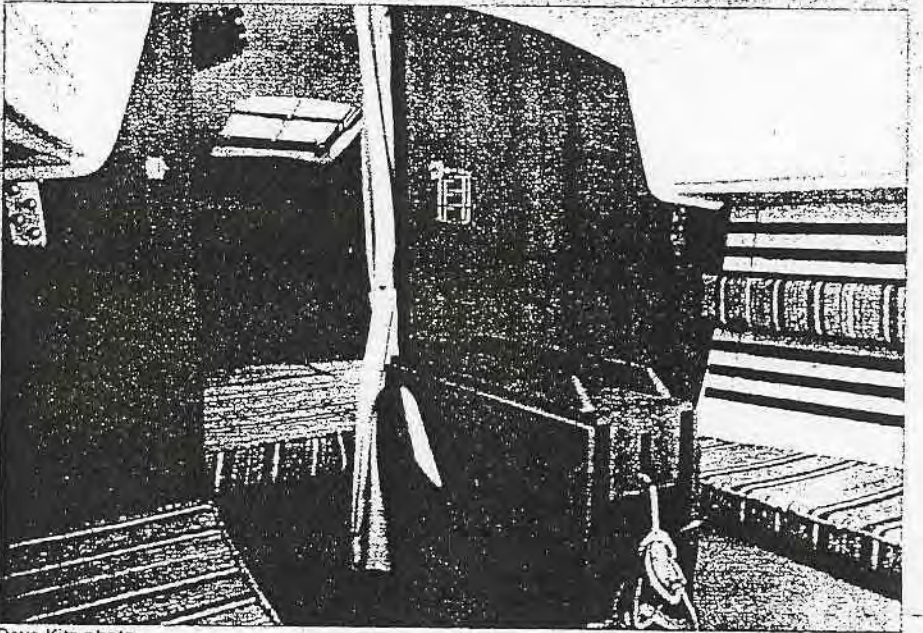

Dave Kitz photo

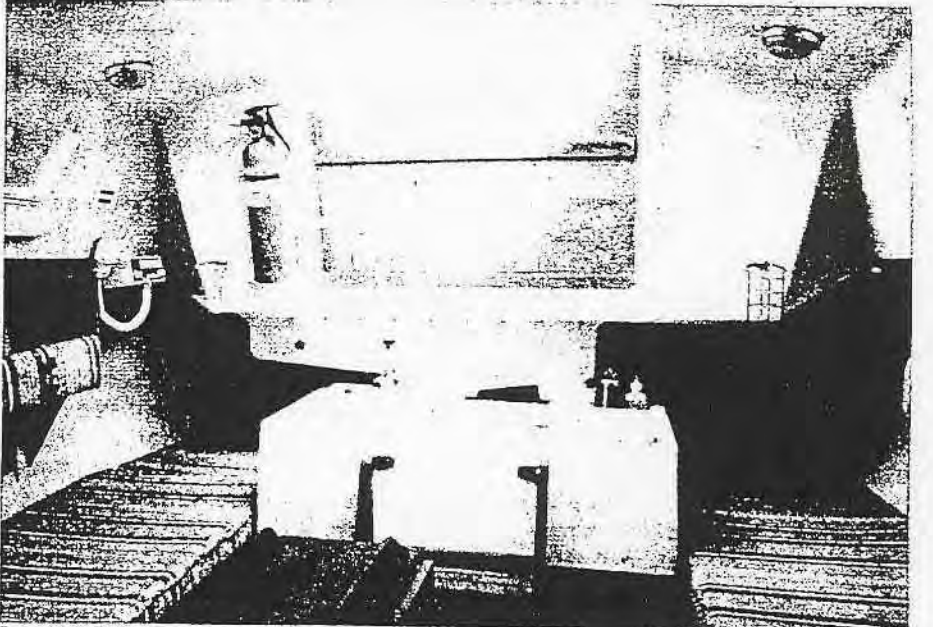

Dave Kitz photo

derneath the starboard seat. Forward of that is a shallow insulated locker for drinks, that drains into the cockpit scuppers.

But it's the Hunter's features belowdecks that are so likely to make her a truly successful design. To begin with, headroom at the companionway is five feet, and I could stand easily in the cabin by just bending over slightly. At the very least, the Hunter has "honest" sitting room, providing good comfort for lounging around, and this is super important. Most ladies would be comfortable standing erect. With the large hatch open, of course, you can stand in the companionway while working in the galley.

Vee berths are wide and comfortable, and in place of the usual shelf running fore and aft above them, are "vee berth bags" that snap onto the hull sides and can be detached and loaded at home, completely eliminating the need for luggage or other gear that's so difficult to stow. There is also substantial storage beneath the vee berths.

The head is positioned to starboard and just aft of the vee berths, giving as much privacy as you can expect in a cruiser of this size.

In the main salon, a drop leaf table has leaves on both sides and also houses the centerboard rope, which I found to work almost effortlessly. Under the settee on the port side are two lockers. The aftermost is molded in with either top or front loading; ideal for storage of an outboard or even sails, since it is lined and clean. On the starboard side are three lockers, the center one also being molded in for food storage or anything that needs to be kept dry.

The galley features a sink, another dry storage bin, and a single burner alcohol stove, which pulls out of a drawer on the starboard side, permitting the stove to be used in the cockpit, on the beach, or wherever. Underneath the galley is a 48-quart Igloo ice chest.

So far, the Hunter 22 has qualified eminently as a small cruiser. We have found she will go to weather, which is an absolute must when beating near a lee shore in a stiff breeze; she can be managed easily; and she has the accommodations needed for our great inland seas. Now, what about trailerability?

In the design of the Hunter, trailerability obviously received high priority. The spreaders are

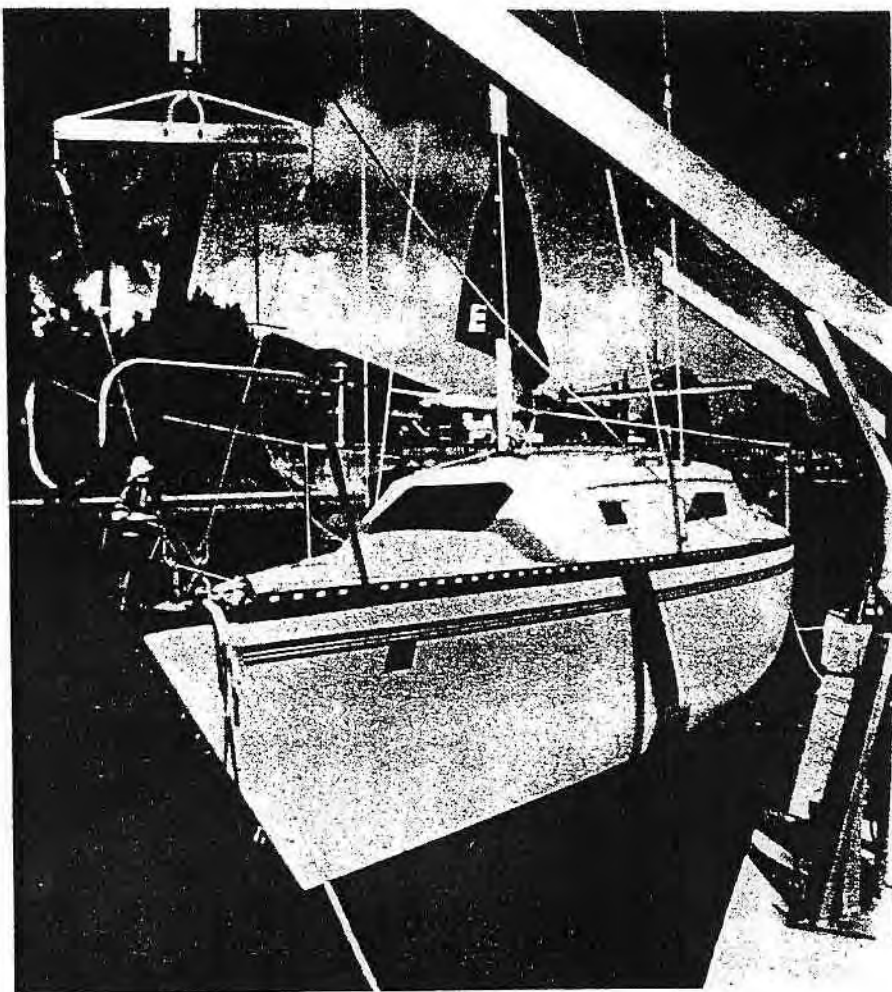

The Hunter 22's bow pulpit has a radius bend in it to cradle one end of the mast when trailering; the other end of the mast hooks into the gudgeons at the stern.

modestly swept back, enabling all the rigging to be pre-hooked. As a consequence, the factory claims that one person can pretty much raise the mast into position by pulling on the forestay. The manufacturer supplies a carrier for the mast which hooks into the gudgeons at the stern, and the bow pulpit has a radius bend in it to cradle the other end of the mast. Thus, the factory points out, the boat can be launched *before* stepping the mast if you are in a crowded area or when there are problems presented by trees or power lines.

Lastly, the manufacturer includes as standard everything — within the limits of reason — you will need for safety and comfort in what is called their "Cruise Pac." Life jackets, blocks, bow and stern pulpit, stanchions and life lines, cabin lights, opening hatch, side-opening ports, stove, freshwater tank and pump, running lights, anchor and rope in bow anchor well, bilge pump, bell, horn, and all other Coast Guard required equipment are standard.

So, welcome to the world of the small cruiser. You'll sharpen your

sailing skills, go places you'd never see in a large cruiser, and the chances are you'll be unhurried, unharried, and unhassled by all the burdensome gear you think you must carry in a big boat. You'll sail off in airs that won't budge some big boats; entering a strange harbor won't necessarily mean only looking for a repair man to fix some exotic piece of equipment; and think of the dough you'll save.

But, most important of all, you don't have to wait until you can afford the large cruiser. Go now! □

SPECIFICATIONS

LOA	22-ft. 3-in
LWL	18-ft. 4-in
Beam	7-ft. 11-in
Draft Board up	2'-in
Board down	5-ft. 0-in
Sail Area	225 sq. ft.
Rudder draft	27-in
Displacement	3,200 lbs
Ballast	1,300 lbs
Price as tested	
Manufactured by:	
	Hunter Marine
	P.O. box 1030
	Alachua, Florida 32615

TANDING RIGGING

1 HEADSTAY	5/32"	1x19	28'1 1/4"
1 BACKSTAY	5/32"	1x19	29'11"
2 UPPER SHROUDS	5/32"	1x19	26'9 1/4"
0 LOWERS SHROUDS	5/32"	1x19	14'

UNNING RIGGING

1 MAIN HALYARD	3/8"	61'
1 JIB HALYARD	3/8"	61'
1 MAIN SHEET	3/8"	50'
1 JIB SHEET	3/8"	70'
1 VANG	3/8"	25'
1 DOWNHAUL	3/8"	5'
2 JIFFY REEF	1/4"	18'

TOPPING LIFT TAIL 1/4" 6'