



HUNTER®

MARINE CORPORATION

AN EMPLOYEE OWNERSHIP COMPANY

We Go The Distance



Operator's Manual

H18



Thank You!
From the General Manager

Dear Hunter Owner,

Congratulations and welcome to the Hunter family! As a Hunter owner, you will enjoy the quality and the attention to detail for which Hunter Boats are renowned. Hunter and your dealer are committed to your service and total satisfaction.

This Operator's Manual will acquaint you with the proper operation and maintenance of your new Hunter boat, as well as boating safety, which is our primary concern, whether in ports or at sea.

The new boat warranty registration form you signed at the time of delivery will be sent to us by your dealer. This registers the one year warranty and establishes your contact information in our system. It will also activate Hunter's Customer Satisfaction program (CSS), our effort to insure the highest level of satisfaction and enjoyment with your new Hunter. Within a few weeks of delivery you will receive a letter asking you to complete an online questionnaire primarily about your experience with the dealer. Several months later you will receive a second letter asking you to evaluate the boat. We value your opinion and hope that you will take the time to complete both surveys.

As you already know, we work with the highest quality equipment manufacturers to supply the components for your boat. To receive full warranty coverage on all the individual components, such as engine and rigging, be sure to complete and return to the Original Equipment Manufacturers (OEM) warranty cards to activate the individual warranties for these important components. You will find them in the owner's packet that also contains the OEM manuals for this equipment. Please remember all the information contained in the OEM manuals supersedes the information contained in this manual.

Finally, if you are new to boating, be certain to learn the proper rules of seamanship to ensure the safety of your passengers. Refer to Chapman's Piloting, Seamanship, and Small Boat Handling Manual for important and useful information concerning this aspect of boating. Attend a safe boating course offered by the United States Coast Guard Auxiliary, United States Power Squadron, or any enterprise experienced in conducting safe boating courses.

Thank you for choosing Hunter. I am confident your new boat will provide you and your family with years of enjoyable boating.

Thanks from Hunter G.M.

Mike Williams
General Manager

As the owner of a Hunter, you have chosen one of the finest boats money can buy.

Hunter Corporation, is one of America's oldest privately held boating companies. In February 1996 Hunter became an employee ownership company. We continue to be dedicated to giving you a quality boat that will bring you years of enjoyment whether you're spending a day at the marina or cruising down a waterway. Performance, dependability, safety, and comfort is more than just a catchy phrase at Hunter. It is the basis for every step of design and construction to assure you of many pleasure-filled years of boating.

A Proud Heritage

With every Hunter, three generations of experience combine with modern engineering and production techniques provide you one of the most affordable, full featured sailing boats in the industry today.

From the stem to the stern, every piece of equipment and its placement has been engineered to provide the most seasoned sailer with the best advantage on the water. Hunter has included everything to make ours the most complete sailing vessel on the market today.

How to Use this Manual

Many people read their operator's manual from beginning to end when they first receive their new boat. If you do this, it will help you learn about the features and controls for your new boat. In this manual, you'll find that pictures and words work together to explain things quickly.

Table of Contents

A good place to look for what you need is in the Table of Contents in the beginning of this manual. It is a list of the chapters and the page number where you'll find them.

Safety Warnings and Symbols

In Boating Safety section you will find a number of cautions, warnings, and danger symbols to tell you about things that could hurt you.

In this chapter we tell you where the hazards are. Then we tell you what to do to help avoid or reduce them. Please read this chapter carefully, to prevent yourself or someone else from possible injury.

Any questions regarding your Hunter ® or this manual contact Customer Service at:

Hunter Corporation
Route 441, Post Office Box 1030
Alachua, FL. USA 32616
Phone: (386) 462-3077
Fax: (386) 462-4077
e-mail: customerservice@huntermarine.com
(8am to 5pm EST) 1-800-771-5556

Operator's Manual at a Glance

1. Introduction

2. Documents and Forms

3. Warranty

4. Boating Safety

5. Sails and Rigging

6. Getting Underway

7. Maintenance

8. Glossary

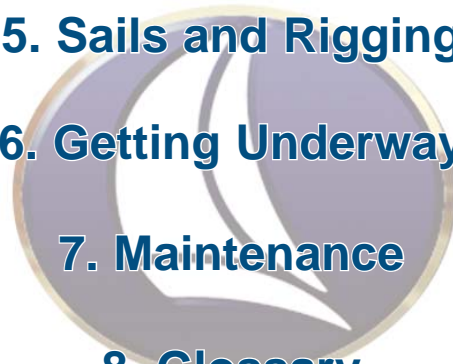

Table of Contents

1. Introduction	1.1	5. Sails and Rigging	5.1
1.1 The Manual Packet	1.2	5.1 Main Rig Components	5.2
1.2 Your Responsibilities	1.2	5.2 The Mast	5.2
1.3 Dealers Responsibilities	1.3	5.3 The Boom	5.2
1.4 Sources of Information	1.3	5.4 The Sails	5.2
1.5 Equipment Manufacturer Manuals	1.4	5.5 Reefing Instructions	5.2
1.6 Warranties	1.4	5.6 Shaking Out a Reef	5.3
1.7 Hull Identification Number	1.4	5.7 Spinnaker (Option)	5.3
1.8 Manufacturers Certifications	1.4	5.8 Protecting your Rigging	5.4
1.9 Service Parts and Repair	1.5	Sailplans & Sail Specification	5.5
		Standing Rigging Detail	5.6
2. Documents and Forms	2.1	Standing Rigging Details (Furling)	5.7
Documents and Forms overview	2.2	Mast Detail	5.8
Out of Water Inspection	2.4	Mast and Boom Detail	5.9
In Water Inspection	2.4	Spreader Detail	5.10
Pre-Departure Checklist	2.5	Main Sheet Detail	5.11
After Sailing Checklist	2.5	Reefing Layout	5.12
Pre-Delivery Service record	2.6	Vang Detail	5.13
Float Plan	2.7	Optional Spinnaker	5.14
Maintenance Log	2.8	Center Board Detail	5.15
		Rudder And Tiller Detail	5.16
3. Limited Warranty	3.1	Trailing Detail	5.17
Intentional Blank	3.2		
Warranty Information	3.3	6. Getting Underway	6.1
Restrictions to Warranties	3.5	6.1 Boarding your Boat	6.2
Owner Information Card	3.6	6.2 Launching	6.2
Warranty registration	3.7	6.3 Getting Underway	6.3
Sample Form Letter	3.8	6.4 Returning to Port	6.4
		6.5 Emergency Operations	6.5
4. Boating Safety	4.1		
4.1 Safety	4.2	7. Maintenance	7.1
4.2 Carbon Monoxide Hazard	4.4	7.1 Maintenance Materials	7.2
4.3 Other Dangers	4.10	7.2 Exterior	7.2
4.4 Fire	4.12	7.3 Mechanical Systems	7.4
4.5 Distress Signals	4.12	7.4 Periodic Maintenance	7.4
Lightning Illustration	4.14	7.5 Storage and Lifting	7.5
Deck Arrangement	4.15	7.6 Fitting out after Storage	7.6
General Arangement	4.16	Routine Maintenance	7.7
Dimensions and Capacities	4.17		
Deck Hardware	4.18	8. Glossary	15.1

THIS PAGE INTENTIONALLY LEFT BLANK



H U N T E R[®]

MARINE CORPORATION

AN EMPLOYEE OWNERSHIP COMPANY

We Go The Distance

Chapter 1

Introduction

H18



1.1 The Manual Packet

This operator's manual, along with your owner's packet, has been compiled to help you to operate your boat with safety and pleasure. The Owner's / Operator's Manual:

- Describes basic safety information;
- Describes some of the features of your boat;
- Describes the equipment on your boat;
- Contains fundamentals of the use of that equipment;
- Contains fundamentals of the use of your boat.

However, please note that the information in this manual only summarizes more detailed information in the equipment manuals. The summaries are intended to be a convenient reference for daily use. OEM manuals take precedence over the information in the manufactures documents.

This information does not give you a course in boating safety, or how to navigate, anchor, or dock your boat. Operating a boat, sail or power, requires more skills, knowledge and awareness than is necessary to operate a car or truck.

1.2 Your Responsibilities

Please keep this manual in a dry and secure but readily accessible place and leave it on the boat at all times! Make sure to hand over this manual to the new owner if you decide to sell the boat.

If this is your first boat of this type or you are changing to a new boat you are not familiar with, please insure that you obtain handling and operating experience before assuming command. For your safety, and the safety of your passengers you must:

- Take a course in Boating Safety;
- Get instruction, or aid in the safe and proper handling of your boat;
- Familiarize yourself and your passengers of the locations, and use of all safety, and essential operating equipment.

Understand and follow the rules of the road;

- Learn how to navigate a boat in all sea, and weather conditions;
- Register your boat, contact state boating authorities, or the marine dealer for the registration requirements.

Boating Safety courses provide owners and operators with the opportunity to gain knowledge and experience in a variety of skills:

- Navigation
- Seamanship and boat handling
- Rules of the Road
- Knowledge of federal, state, and local regulations
- Weather prediction
- Safety at sea
- Survival in bad weather
- Respect for others on the water
- First aid
- Radio communication
- Distress signals
- Rendering assistance to others
- Use of lifesaving equipment
- Pollution control
- Knowledge of the boat and its systems
- Seaworthiness
- Leaving or approaching a dock mooring
- Anchoring and weighing anchor
- Beaching the boat and shallow water operations
- Towing and being towed
- Handling mooring lines and tying up
- Procedures for emergencies including fire, flooding, collision, and medical emergencies, etc.

Even when your boat is categorized for them, the sea and wind conditions corresponding to the design categories A, B, C, or D (see the design category example at the end of this section.) can range from strong gale to severe conditions where only a competent, fit and trained crew handling a well maintained boat can safely operate.

We would like to hear your comments or suggestions concerning our manuals. Did you find the information helpful? Was the information delivered in a clear precise manner? Was the information thorough enough to help you with your new boat? Please call us at (386) 462-3077 to speak to our Manual Department, if you have questions, or comments, concerning the manual. Please note, this department does not have design or warranty information you will need to contact those departments for such information.

Fig. 1.1 Design Categories

Sea and wind conditions for which a boat is assessed by the International Standard to be suitable, provided the craft is correctly handled in the sense of good seamanship and operated at a speed appropriate to the prevailing sea state.

Design Category A (“ocean”)

Category of boats considered suitable to operate in seas with significant wave heights above 4 m and wind speeds in excess of Beaufort Force 8, but excluding abnormal conditions, e.g. hurricanes.

Design Category B (“coastal”)

Category of boats considered suitable to operate in seas with significant wave heights up to 4 m and winds of Beaufort Force 8 or less

Design Category C (“inshore”)

Category of boats considered suitable to operate in seas with significant wave heights up to 2 m and a typical steady wind force of Beaufort Force 6 or less.

Design Category D (“sheltered waters”)

Category of boats considered suitable to operate in waters with significant wave heights up to and including 0,30 m with occasional waves of 0,5 m height, for example from passing vessels, and a typical steady wind force of Beaufort 4 or less.

REF: EN ISO 12217

An orientation in the general operation and mechanical systems of your boat;

An explanation of the Hunter CSI Program and Hot Alert process for same.

A copy of the Product Delivery Service Record form” completed by you and the dealer during your inspection of the boat;

A review of all warranty information and how to obtain warranty service;

The complete Owner’s Packet.

If you do not receive these materials, forms, or information, or you have any questions contact your dealer, or call 1-800-771-5556

1.4 Sources of Information

In North America, contact one of the following for Boating courses:

- U.S. Coast Guard Auxiliary
- U.S. Power Squadron
- Canadian Power and Sail Squadrons
- Red Cross
- State Boating Offices
- Yacht Clubs

Contact your dealer or the Boat/U.S. Foundation at 1-800-336-2628

Outside of North America, contact your boat dealer, or your government boating agency for assistance.

Hunter recommends that you read the following:

Piloting, Seamanship and Small Yacht Handling (Chapman)
Motor Yacht and Sailing
P.O. Box 2319, FDR Station
New York , NY 10002

1.3 Dealer's Responsibilities

In addition to a pre-delivery check and service of your boat, your dealer should give to you:

A description and demonstration of the safety systems, features, instruments, and controls of your boat;

Hunter recommends that you purchase and read the following:

Yachtsman Handbook
by Tom Bottomly
Motor Yacht and Sailing
P.O. Box 2319, FDR Station
New York, NY 10002

The Complete Book of Maintenance and Repair
by Dave Kendall
Doubleday and Co.
Garden City, NY 11530

Pleasure Yachting and Seamanship
U.S. Coast Guard Auxiliary
306 Wilson Road Oaklands
Newark, DE 19711

1.5 Equipment Manufacturer Manuals

Hunter purchased various equipment and components from other manufacturers and installed them on your boat while it was being built. Examples include the engines, pumps, and the rigging. Most OEMs (Original Equipment Manufacturers) have provided operation and maintenance manuals for your boat's equipment. Keep OEM manuals with your Hunter Operator's Manual in a safe and accessible place. Be sure to pass them along to the new owner if you sell your boat.

NOTE: The OEM manuals take precedence over the Hunter Operator's Manual. If information in the Hunter Operator's Manual differs from that in the OEM manuals, follow the information in the OEM manuals.

1.6 Warranties

Nearly all OEM equipment has its own limited warranties. Warranty registration cards are in your Operator's packet.

Locate and read the individual warranties; put them together for easy, future reference.

For international owner's; your warranty can be found in your CE compliant Owner's Manual.

For U.S. and non-EU compliant countries, your warranty

info can be found in the Warranty section, chapter 3 of the Operator's Manual.

1.7 Hull Identification Number (HIN)

The "Hull Identification Number" located on the starboard aft side, is the most important identifying factor, and must be included in all correspondence and orders. Failure to include it creates delays. Also of vital importance are the engine serial numbers and part numbers when writing about or ordering parts for your engine. Refer to the engine manufacturers manuals for locations of engine serial numbers, and record them for future reference.

US-HUNPCXXXDXXX

Hull Number format:

"US" - country origin, "HUN" - Manufacturer, "C" - length code, "XXX" - hull number, "D" - month code, "X" - year code, "XX" - model year

1.8 Manufacturers Certifications

As a boat manufacturer, Hunter builds their products to guidelines established under the Federal Boat Safety Act of 1971. The act is promulgated by the U.S. Coast Guard who has authority to enforce these laws on boat manufacturers that sell products in the United States. Hunter ensures that all of its products comply with these laws.

The NMMA, National Marine Manufacturers Association, provides Hunter with a third party certification. The NMMA is an organization that represents the marine industry and assists manufacturers, boat dealers, marinas, repair yards and component suppliers in areas of legislation, environmental concerns, marine business growth, and state and federal government agency interaction. The third party certification that Hunter participates in, uses well known Standards and Recommended Practices of the ABYC, American Boat and Safety Council.

We at Hunter participate extensively in the ABYC, which is all non-profit, and develops and publishes voluntary standards and recommended practices for boat and equipment design, construction, service and repair. We utilize all applicable ABYC standards in the construction of Hunter boats.

Finally Hunter sells their products worldwide, and as such must conform to the various rules and regulations required by other countries. Most notably are the ISO

standards in Europe which require the application of the CE (Common European) mark. This mark, much like the NMMA certification here in the U.S., gives you the boat owner specific information concerning your boat.

1.9 Service, Parts, and Repair for your Boat

When your boat needs serviced, parts, or repair, take it to an authorized Hunter dealer. To find a dealer in your area call 800-771-5556, or internationally you can call 01-305-824600. To find repair and parts facilities for the equipment installed on your boat, refer to the manual for that component.

If a problem is not handled to your satisfaction:

Discuss any warranty related problems directly with the service manager of the dealership or your sales person. Give the dealer an opportunity to help the service department resolve the matter for you.

If a problem arises that has not been resolved to your satisfaction by your dealer, contact Hunter at 800-771-5556, and the appropriate customer service department information will be provided to you.



H U N T E R[®]

MARINE CORPORATION

AN EMPLOYEE OWNERSHIP COMPANY

We Go The Distance

Chapter 2

Documents
and
Forms
H18



Hunter 18 • Documents and Forms

Your Hunter dealer completes the Pre-Delivery Inspection Report (Fig. 2.1) before you take delivery of your boat. It is the dealer's responsibility to both you and to Hunter to give your boat a final inspection. The purpose of this inspection is to assure proper adjustment and operation of the entire vessel. Your dealer should provide you with the Pre-Delivery Inspection Report at the time of delivery.

Hunter will not pay warranty costs for items that should have been covered in the pre-delivery service inspection and recorded on the Pre-Delivery Inspection Report.

Owners must coordinate with the dealer to insure Hunter warranty registration is completed and returned to Hunter.

Inserted at the end of this section are several records you will find helpful.

Use the BOAT RECORD (Fig. 2.2) to record all important information about your boat and its equipment. After your dealer has recorded all the information, remove the record from your Owner's Manual and store in a safe place. Do not keep this form aboard your boat.

The FLOAT PLAN (Fig 2.4) provides a record of your destination, departure and return times, boat description, passenger list, and other information about the trip you have planned. At the bottom of the form is space for listing emergency phone numbers in case your return is delayed past the expected time. It also has space for indicating information about the person filing the report. Leave the completed form ashore with a responsible person. We recommend you make several copies of this form each boating season to make sure you have a good supply.

The MAINTENANCE LOG (Fig 2.5) helps to keep maintenance records in one place. Using this log will allow you to track maintenance work that has been completed and to determine when maintenance is required. Your dealer will also find this information helpful. If you decide to sell your boat, the maintenance record will make your boat seeable because it tells prospective buyers that you have taken good care of your boat.

The ACCIDENT REPORT. No one likes to think about having a boating accident, but boating accidents do happen. You must file an accident report after a boating accident just as you must file an accident report after an automobile accident. A copy of the U.S. Coast Guard Accident Report is included at the end of this section.

You can get more copies of the report by calling the U.S. Coast Guard Boating Safety Hotline at 1-800-368-5674.

You must file this report with the U.S. Coast Guard within 48 hours after an accident resulting in one of the following:

A person disappears from a vessel under circumstances that indicate death or injury

Personal injury requiring medical treatment beyond first aid

Damage to the vessel or property damage

Complete loss of the vessel

State statutes determine whether you must file an accident report in this case. An accident report must be filed if the damage exceeds a threshold dollar value as established by the states, the threshold is \$100-\$200. Call the Boating Safety Hotline (800-368-5647) to verify the threshold for a particular state.

Note: State and local agencies may also have accident reporting requirements. Check with local enforcement agencies or with your local Hunter dealer regarding local requirements.

All Hunter boats are built in compliance with applicable United States Coast Guard regulations and recommendations at the time of construction.

Hunter boats comply with the standards developed by the National Marine Manufacturers Association (NMMA) for its Boat Certification Program.

The locator drawings will help you find the location of devices and equipment.

NOTE: Efforts have been made to make the drawings in this manual consistent with production. However, in the effort to improve this vessel, modifications have been made in the design that may date some of the drawings in this manual.

On the next few pages you will find sample forms for some of the issues dealing with your new boat. Familiarize yourself with these forms, use them, they can be very handy.

Dear Hunter Owner,

Attached you will find a list of items and recommendations that we believe should be incorporated into your own ongoing list of preventative maintenance items and safety check points. THIS LIST SHOULD NOT BE CONSIDERED A COMPLETE SERVICE MANUAL OR THE ONLY ITEMS ON YOUR BOAT IN NEED OF ROUTINE MAINTENANCE, INSPECTION OR ATTENTION.

You will find that we address commonly found optional equipment items installed on Hunter boats, as well as most standard equipment from Hunter Marine. Owner's need to familiarize themselves with individual equipment manuals on all such items, especially aftermarket purchases or optional equipment installed by your dealer or Hunter Marine. This should insure that you are following the manufacturer's recommendations for proper maintenance and up-keep.

We strongly recommend that all owners complete a Power Squadron course followed with a complementary boat inspection before leaving the dock. To locate a Power Squadron in your area please visit < www.usps.org >.

Reviewing and familiarizing yourself with the Chapman's Piloting Manual is also highly recommended for every boat owner. This manual contains demonstrations for safety drills which should be practiced routinely, dealing with adverse conditions, general boat handling and recommended safety equipment. Our opinion is that no boat owner should operate a boat without first reviewing this manual and without having ready access to it while sailing.

We hope that this list will be beneficial to you in your ongoing maintenance and upkeep. Safe boating!

Thank You

Hunter Marine

Preliminary care and maintenance checklist

A qualified Technician should be used if you are not completely confident in your ability to make repairs or inspections.

Out of Water Inspection

Pre-launch inspection

- Drain plug installed
- Rudder swings easily
- Rudder and post inspected for cracks and/or concealed damage (may require removing rudder)
- Tiller handle properly aligned, fits securely and operational
- Hull freshly cleaned and waxed (free of gelcoat damage)
- Mooring, safety lines and fenders onboard and in good condition
- Boat is free of internal and external water leaks above water line

(Failure to stop water intrusion could result in permanent damage or deterioration of structural coring materials, internal wiring and cause mildew and molding)

Mast Assembly

- Review manufacturers manual for maintenance and up-keep
- Spreaders securely fastened
- Mast and spreaders free of corrosion and stress cracks
- Standing rigging and pins inspected for wear, tear, corrosion and cracking
- Manual wind indicator installed on masthead
- Headsail furling system installed inspected per manufacturers recommendation
- Running rigging inspected for wear and tear
- Mast step stand-up blocks secured and operational
- Main Sail, jib sail inspected for wear and tear.
- Specified pre-bend and diagonal tensions attained in mast. See mast owners manual.

Topside Inspection

- Canvas properly cleaned and installed
- Rubrail sealed secured to hull
- Load bearing hardware securely fastened. This includes but is not limited to chainplates, winches and handrails
- Topside surface clean and free of gelcoat damage
- Safety gear onboard readily available and up to date.
See Chapman's Manual and US Coast Guard website at < www.uscg.mil >for details.
- Boat owner's manual onboard
- Lower unit oil at full mark (per engine manual)

In Water Inspection

Dockside inspection of Engine, Pre-start sequence and operating system

- Review engine manual for maintenance requirements and proper starting procedure
- Air bled from fuel lines and system
- No fuel leaks at any fittings
- Throttle linkages smooth and operational

- Shutdown system operational
- Correct Idle rpm (per engine manual)
- Fuel level indicators operational
- Throttle cable tension set properly
- Shifter operation correct
- No fuel / oil / water leaks on engine

Pre-departure Checklist

- Check weather conditions and tides
- Check food Supply
- Foul weather gear
- Fuel
- Water
- Sunscreen and sunglasses
- Tools
- Docking gear
- Check radio operation
- Float plan to a friend or Coast Guard
- Check steering lock to lock
- Check mast for rigging irregularities and tightness
- Halyards and sheets are ready to run
- no lines or obstructions near propeller or bow
- Stow all loose gear

After Sailing Checklist

When leaving your Hunter at the dock for more than a short time, it is a good idea to review the following checklist to make sure everything is in order. This will help protect the various parts of your boat and add considerably to their attractiveness and usable life.

- Flake or furl mainsail and cover, or remove and bag.
- Remove and stow all portable deck hardware such as snatch blocks, winch handles, etc.
- Secure the boom to the topping lifts and set it firmly amidships with the main sheet purchase or remove rig completely.
(It is also a good idea to rig a line from the steering wheel or tiller to a convenience cleat to keep the rudder from swinging back and forth with the motion of the water or employ the wheel brake if so equipped.)
- Attach the shackle ends of all halyards to convenient fittings and take up slack.
- Coil and stow all lines.

Fig. 2.1

Pre-delivery Service Record

DEALER: _____ ENGINE: _____
 MAKE: _____ OWNER: _____
 PORT ENGINE NO: _____ STBD. ENGINE NO: _____
 BOAT NAME: _____ REGISTRY NO: _____
 OPERATION _____ INITIALS _____ OPERATION _____ INITIALS _____

BEFORE LAUNCHING

1. Hull Side Clean and Gelcoat
2. Bright work clean and finish
3. Decks cleaned and gelcoat
4. Interior Finish
5. Upholstery clean and carpet in place
6. Bilge cleaned.
7. Bottom clean and paint
8. Both shafts turn freely
9. Engines and Generator intakes installed
10. All hull fittings sealed
11. All drain plugs tight, (hull, engines, generator, muffler)
12. Sacrificial Anodes installed

WITH BOAT IN WATER

13. Hose test for cabin and window leaks
14. No water leaks at thru hull fitting with seacocks
15. No water leaks at shaft or rudder
16. With all switches off - no spark when battery cable touched to post
17. All electrical equipment operating including: horn(); running light(); bilge pump()
18. Toilet operates
19. Water (pressure) system operates
20. Galley stove operates
21. With fuel tanks full, no fuel leaks at fill pipes, overflow vent, or at any fuel line connections
22. With coupling disconnected, engine and shaft alignment

INSPECTION DATE: _____

DEALERS SIGNATURE: _____

OWNERS SIGNATURE: _____

COMMENTS: _____

BEFORE STARTING ENGINES

23. All engine wiring in good order & tight
24. Throttle control and cable travel
25. Clutch control and cable travel
26. Crankcase oil level at FULL mark
27. Reverse gear oil level at FULL mark
28. No fuel leaks in fuel lines, at fittings, at fuel filter, fuel pump
29. No engine water or oil leaks
30. Oil pressure and exhaust water flow
31. Idling speed set at 700-800 RPM and is in proper adjustment

WATER TEST BOAT

33. Engine performance
34. Instruments are registering properly
35. Top RPM wide open throttle for one minute after warm-up
36. Boat performance

FINAL CHECK:

37. All accessory equipment operating
38. Carpets and drapes installed and clean
39. All loose equipment on boat ready for new owner.

Float Plan

Name of Operator _____ Age _____

Address _____

Phone _____

Boat Make _____ Model _____

Length _____ Hull Color _____ Deck Color _____

Registration No. _____ Home Port _____

Radio frequencies _____

Equipment on Board, PFDs, Flares, Anchor _____

Fuel Capacity _____ Water Capacity _____

Distinguishing Features _____

Departed from _____

Date _____ Time _____

Destination _____

Stops _____

Estimated time of Arrival: Date _____ Time _____

Name, age, address and phone number of other persons on board:



H U N T E R[®]

MARINE CORPORATION

AN EMPLOYEE OWNERSHIP COMPANY

We Go The Distance

Chapter 3

***Limited
Warranty***

This Page Intentionally Left Blank

Hunter • Limited Warranty



HUNTER®
MARINE CORPORATION
AN EMPLOYEE OWNERSHIP COMPANY
DISCOVER THE DIFFERENCE

Your Hunter Limited Warranty

Hunter offers a limited warranty on every Hunter boat sold through an authorized Hunter dealer. A copy of this warranty is included here, and in your Operator's Manual. If for some reason you are not able to understand, read, or view this manual, please contact your local dealer for a replacement copy.

We stand behind the quality of your boat with our limited warranty, which you should review. To insure the operation and validity of your limited warranty, please complete the attached card and send it to us within ten (10) days of the purchase date. Section 15 of the U.S. Federal Boat Safety Act requires registration of a boat's first owner. The warranty data should also be re-corded in the space below for your own reference.

The following warranties apply to all 2011 Model Year boats produced by
HUNTER MARINE CORPORATION:

LIMITED ONE-YEAR WARRANTY

Hunter Marine warrants to the first-use purchaser and any subsequent owner during the limited warranty period that any part manufactured by Hunter will be free of defects caused by faulty workmanship or materials for a period of twelve (12) months from the date of delivery to the first-use purchaser under normal use and service. During this period, as the sole and exclusive remedy, Hunter's obligation under the warranty is limited to the repair or replacement of any such defective part.

LIMITED FIVE-YEAR HULL STRUCTURE AND BOTTOM BLISTER WARRANTY

Hunter warrants to the first-use purchaser and any subsequent owner during the limited warranty period that the hull of each boat will be free from structural defects in materials and workmanship for a period of five (5) years from the date of delivery to the first-use purchaser under normal use and service.

This limited warranty applies only to the structural integrity of the hull and the supporting pan/grid or stringer system. Hulls, pan/grid or stringers modified in any way or powered with engines other than the type and size installed or specified by Hunter are not covered by this limited warranty. As the sole and exclusive remedy, Hunter's obligation under the warranty is limited to repair or replacement of any such defective part.

Hunter • Limited Warranty

Hunter also warrants to the first-use purchaser and any subsequent owner during the warranty period that the boat will be free from gelcoat blistering on underwater surfaces of the hull, excluding the keel and rudder, for a period of five (5) years from the date of delivery to the first-use purchaser under normal use and service. During this period, Hunter will supply or reimburse an authorized Hunter dealer for all of the parts and labor required to repair a blistered underwater surface of the hull. The labor cost reimbursement will be based on the Labor Allowance Schedule established by Hunter from time to time, however if the repair is performed by a non-Hunter dealer, the repair cost must be authorized by Hunter in advance and be based on a reasonable number of hours as determined by Hunter. Hunter will not pay transportation, hauling, launching, bottom paint, storage, dockage, cradling rental, rigging and derigging, or other similar costs. It is recommended that the repair be done during a seasonal haul out for service or storage.

PLEASE KEEP THIS MANUAL IN A SAFE PLACE AND HAND IT OVER TO THE
NEW OWNER IF YOU SELL THE CRAFT.

You should also complete the warranty cards for your engine, stove, head, electric water pump and other accessories. These are enclosed in the manufacturers' manuals that are packaged with your owner's manual.

HUNTER EXPRESSLY DISCLAIMS THE IMPLIED WARRANTIES OF
MERCHANTABILITY AND FITNESS. NEITHER HUNTER OR THE SELLING DEALER SHALL
HAVE ANY RESPONSIBILITY FOR LOSS OF USE OF A BOAT, LOSS OF TIME,
INCONVENIENCE, COMMERCIAL LOSS, OR CONSEQUENTIAL DAMAGES.

Hunter • Limited Warranty

The following circumstances will void the bottom blister limited warranty:

- (1) If the gel-coat has been sanded, sandblasted, or subjected to abrasion or impact.
- (2) If the instructions provided in the Hunter Owner's Manual are not followed according to Hunter's required bottom preparation procedures.

RESTRICTIONS APPLICABLE TO WARRANTIES

These limited warranties do not cover:

- (1.) Paint, sealants, adhesives, window glass, Gelcoat, upholstery damage, plastic finishes, engines, engine parts, bilge pumps, stoves, blowers, pressure water pumps, propellers, shafts, rudders, controls, instruments, keels and equipment not manufactured by HUNTER. Any warranty made and issued by the manufacturer of such items will be, if and where available, provided to the first use purchaser.
- (2.) Problems caused by improper maintenance, storage, cradling, blocking, normal wear and tear, misuse, neglect, accident, corrosion, electrolysis or improper operation.
- (3) Boats used for commercial activities including charter.

THESE LIMITED WARRANTIES ARE YOUR SOLE AND EXCLUSIVE REMEDIES AND ARE EXPRESSLY IN LIEU OF ANY AND ALL OTHER REMEDIES AND WARRANTIES EXPRESSED AND IMPLIED, INCLUDING THE WARRANTIES OF MERCHANTABILITY AND FITNESS FOR A PARTICULAR PURPOSE, WHETHER ARISING BY LAW, CUSTOM, CONDUCT, OR USAGE OF TRADE. SOME STATES DO NOT ALLOW LIMITATIONS ON HOW LONG AN IMPLIED WARRANTY LASTS, SO THE ABOVE LIMITATION MAY NOT APPLY TO YOU. IN THE EVENT THAT IMPLIED WARRANTIES ARE FOUND TO EXIST UNDER THE LAW OF A PARTICULAR STATE, NOTWITHSTANDING THE EXCLUSION CONTAINED HEREIN, THE DURATION OF ANY SUCH IMPLIED WARRANTY SHALL BE LIMITED TO THE DURATION OF THE APPLICABLE LIMITED WARRANTY STATED HEREIN. THE PURCHASER ACKNOWLEDGES THAT NO OTHER REPRESENTATIONS WERE MADE TO HIM OR HER WITH RESPECT TO THE QUALITY OR FUNCTION OF THE BOAT. ANY ORAL STATEMENT OR PRINTED MATERIAL ADVERTISING THE BOAT WHICH SPEAKS TO ANY PERFORMANCE CHARACTERISTIC OF THE BOAT OR ANY OF ITS COMPONENTS SHALL BE CONSIDERED AND CONSTRUED AS AN ESTIMATED DESCRIPTION ONLY AND SHOULD NOT BE RELIED UPON AS AN EXPRESS WARRANTY OR AS THE BASIS OF THE BARGAIN FOR THE BOAT OR ANY OF ITS COMPONENTS.

ANY CONSEQUENTIAL, INDIRECT OR INCIDENTAL DAMAGES WHICH MAY BE INCURRED ARE EXCLUDED AND PURCHASER'S REMEDY IS LIMITED TO REPAIRS OR REPLACEMENT OF ANY SUCH PART(S). SOME STATES DO NOT ALLOW THE EXCLUSION OR LIMITATION OF INCIDENTAL OR CONSEQUENTIAL OR INDIRECT DAMAGES, SO THE ABOVE LIMITATION OR EXCLUSION MAY NOT APPLY TO YOU. THIS WARRANTY GIVES YOU SPECIFIC LEGAL RIGHTS, AND YOU MAY ALSO HAVE OTHER RIGHTS WHICH VARY FROM STATE TO STATE.

Hunter • Limited Warranty

OWNER INFORMATION CARD

HULL IDENTIFICATION NUMBER IS ON THE STARBOARD AFT SIDE OF THE HULL OR TRANSOM. THIS NUMBER MUST BE GIVEN IN ALL NECESSARY CORRESPONDENCE.

HULL NO. _____

DATE DELIVERED TO OWNER _____

YACHT NAME _____

OWNER NAME _____

STREET ADDRESS _____

CITY _____ STATE/COUNTRY _____ ZIP CODE _____

HOME PORT _____

ENGINE MODEL _____ SERIAL NO. _____ PROPELLER SIZE _____

DEALER _____ PHONE _____

STREET ADDRESS _____

CITY _____ STATE/COUNTRY _____ ZIP CODE _____

CUSTOMER SERVICE / WARRANTY

Hunter • Limited Warranty

WARRANTY REGISTRATION

These limited warranties shall not be effective unless the HUNTER Warranty Registration Form and Pre-Delivery Service Record, which are furnished with each new boat, are filled out completely and re-turned to HUNTER within ten (10) days of delivery.

Return of the Warranty Registration Form to HUNTER, signed by both Dealer and Owner, is critical. Warranty coverage cannot be initiated until the completed form is received at HUNTER.

All repairs and/or replacements will be made by an authorized Hunter dealer, or at the option of Hunter, at the Hunter plant. If the repairs are of such a nature that the warranty work must be performed at the HUNTER plant, transportation costs to and from the HUNTER plant shall be paid by the owner. The labor cost reimbursement will be based on a Labor Allowance Schedule established by HUNTER and where not applicable, on a reasonable number of hours as determined by HUNTER. Any repairs and replacements must be approved in advance by an authorized HUNTER service representative.

TRANSFER OF LIMITED WARRANTIES

For 1995 and later hull numbers, the limited warranties will be transferred to a subsequent purchaser of the boat if:

- (1) A notice of the transfer of ownership of the boat is given by the subsequent purchaser in writing to Hunter within thirty (30) days of the transfer.
- (2) The notice shall include the name, address and telephone number of the subsequent purchaser, the date of purchase, the hull number and the name of the seller of the boat.

Hunter will mail to the subsequent purchaser notice of the expiration dates of the limited warranties (see form letter, attached). The transfer of the ownership of the boat will not extend the expiration dates of the limited warranties.

CUSTOMER SATISFACTION SURVEYS

During the first year of ownership, the first purchaser will receive two Customer Satisfaction Surveys - the first (CSS#1) will be received shortly after taking delivery and focuses on the dealer's ability to sell and commission the boat, and the Owner's initial satisfaction. The second survey (CSS#2), nine to ten months into ownership, "measures" dealer service capability and allows the owner to evaluate most of the boat's functional systems and characteristics. Both surveys are dependent upon receipt of the first purchaser's Warranty Registration Form.

Hunter • Limited Warranty

SAMPLE FORM LETTER

March 12, 1997

Mr. John Smith
1456 Joy Street
Sarasota, FL 34266

Dear Mr. Smith,

Thank you for providing written notice of transfer of ownership. We are pleased you have selected a Hunter sailboat and we will make every effort to assure Hunter ownership will be a satisfying experience for you.

Based on the information you have provided, we are pleased to notify you of the expiration dates of the limited warranties.

- The limited one-year New Boat warranty expires (d)_____.
- The limited five-year Hull Structure and Bottom Blister warranty expires (d)_____.

Should you require assistance at any time during ownership, we encourage you to contact your Hunter dealer or to call us directly at 386-462-3077.

Please confirm the information at the bottom of the page and advise us if any corrections are required.

Customer Service Manager

Hull No: HUN_____ Model:_____

Telephone: (H)_____ (B)_____

Date of Purchase:_____

Purchased From: Name:_____

Address:_____

City/State_____ Zip_____

() Private Owner () Dealer

Hunter • Limited Warranty

GRAPHIC EXPLANATION OF WARRANTY COVERAGE

Internal fiberglass pan and fiberglass grid system are covered by the five-year limited warranty.

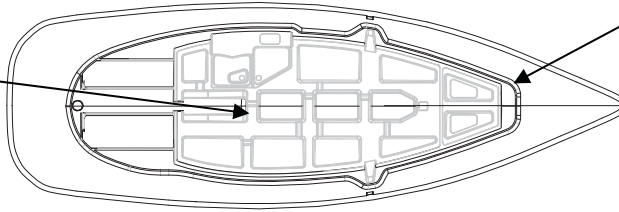

All fiberglass tabbing, overlays, adhesives, epoxy and secondary bonding are covered only by the one-year limited warranty. They are not covered by the five-year limited warranty.

Footnote 1. All wooden bulkheads, modular components, floors, floor supports, paneling, trim, coring materials, faceplates, countertops, fiberglass tabbing, overlays, secondary bonding, sealants, adhesives, gaskets and epoxies are covered only by the one-year limited warranty. They are not covered by the five-year limited warranty.

Footnote 2. Voids located within the deck or hulls gelcoat surface or build laminate are covered only by the one-year limited warranty. They are not covered by the five-year limited warranty.

Footnote 3. Keel and rudder are not covered under the blister warranty. They are not covered under the one-year or five-year limited warranty's.

Deck and deck floor-pans are covered only by the one-year limited warranty. Floor-pan sizes will vary by boat type and size. They are not covered by the five-year limited warranty.

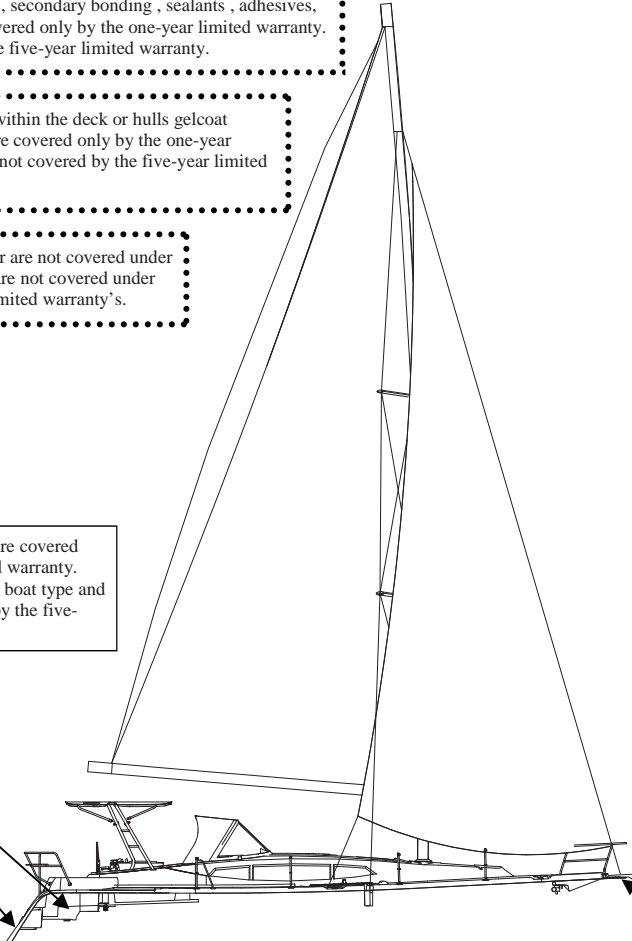

Internal fiberglass pan and fiberglass grid system are covered by the five-year limited warranty.

Hull to deck joint adhesives, epoxies and sealants are covered only by the one-year limited warranty. They are not covered by the five-year limited warranty.

Rudder, keel and centerboards (small boats) are excluded from all warranties. Keel and centerboard leaks at the attachment point are excluded from all warranties.

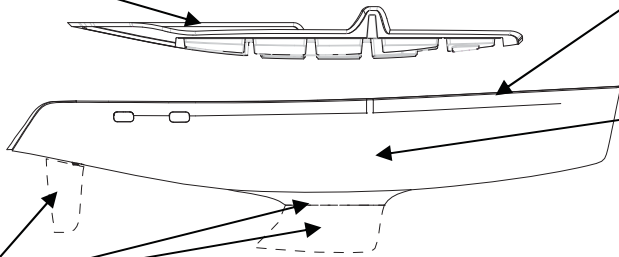

The fiberglass hull component is covered by the five-year limited warranty. Installed items such as (but not limited to) ports, shafting, thru-hulls, vents and struts are not covered by the five-year limited warranty. The rudder and keel are excluded from all warranties.

Hunter • Limited Warranty

GRAPHIC EXPLANATION OF WARRANTY COVERAGE

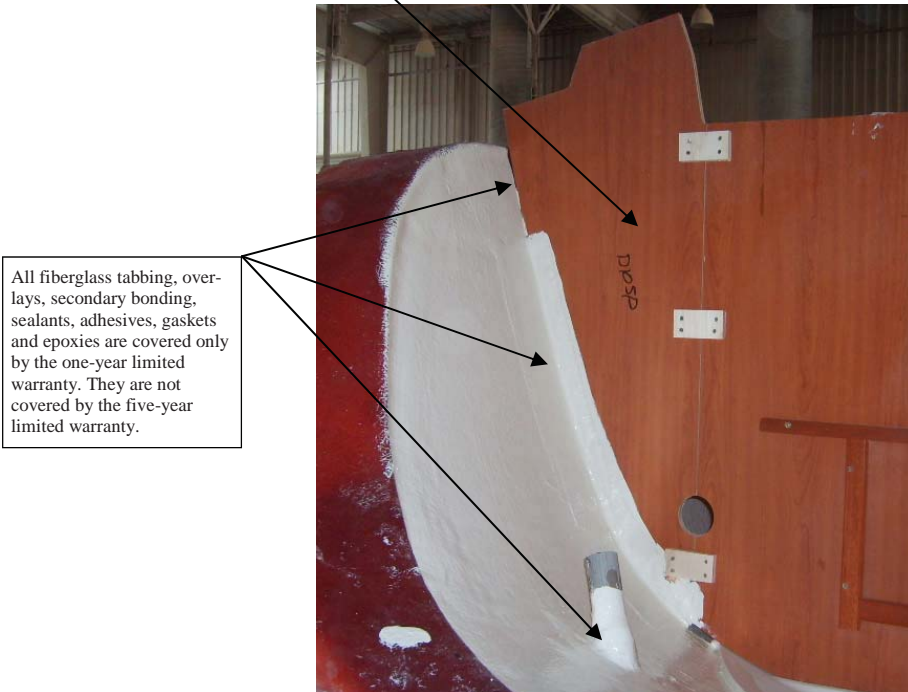
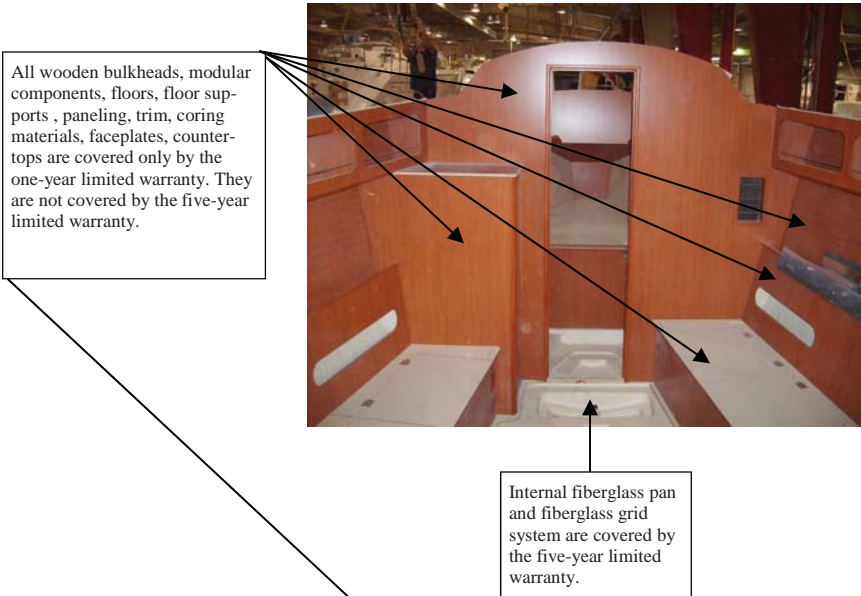



H U N T E R[®]

MARINE CORPORATION

AN EMPLOYEE OWNERSHIP COMPANY

We Go The Distance

Chapter 4

Boating

Safety

H18



As you read your owner's manual, please note hazard warnings which alert you to safety and precautions and unsafe conditions or operating procedures. We have included these warnings because we are concerned about your safety and the safety of your passengers. Hazard statements generally have five parts:

1. The hazard symbol.
2. A signal word which indicates the severity of the hazard.
3. A concise description of the hazard.
4. The results of ignoring the hazard.
5. Steps for avoiding the hazard:

The three signal words which indicate the severity of a hazard are danger, warning, and caution. The meanings they convey are as follows:



Calls attention to immediate hazards that will result in severe injury or death.



Identifies hazards or unsafe practices that could result in personal injury or death.



Indicates hazards or unsafe practices that could result in minor personal injuries, property damage, or component damage.

Also included in this manual are owner advisory statements identified as "Important" or "Note". Unlike the hazard communication statements, they alert you to conditions affecting equipment operation, maintenance, and servicing practices.

Important: This is a general advisory statement or procedure intended to prevent damage to the equipment or associated component.

Note: This is a general advisory statement relating to equipment operating and maintenance procedures. Its intent is to call attention to information more important than normal text.

4.1 Safety

Boating safety and the safety of your passengers are your responsibility. You should fully understand and become familiar with the operating and safety procedures and precautions in this manual and the other manuals in the owner's packet before you launch your new boat.

4.1.1 Safe Operation

Following is general information about safe operation.

Keep your boat and equipment in safe operating condition. Inspect the hull, engines, safety equipment, and all boating gear regularly.

Important: Federal law requires you, the owner, or operator to provide and maintain safety equipment on your new boat. Consult your Coast Guard, state, and local regulations to ensure your boat has all required safety equipment on board. Additional equipment may be recommended for your safety and that of your passengers. Make yourself aware of its availability and use.

BE VERY CAREFUL when fueling your boat. Be sure you know the capacity of your boat's fuel tank and the amount of fuel you use when operating at frequently used engine speeds (RPMs).

Always know all the area's on the boat, know the nautical terms for the different areas of your boat. On the following page, at the end of this chapter we show you a general layout of these terms and illustrate the areas that may be of importance to you.

Make sure you have enough fuel on board for anticipated cruising requirements. In general, use 1/3 of your supply to reach your destination and 1/3 to return. Keep 1/3 in reserve for changes in your plans due to weather or other circumstances.

Be sure lifesaving and fire extinguishing equipment is on board. This equipment must meet regulatory agency standards, and it should be noticeable, accessible, and in a safe operating condition. Your passengers should know where this equipment is and how to use it.

- Keep an eye on the weather. Be aware of possible changing conditions by checking a local weather report before your departure. Monitor strong winds and electrical storms closely.

- Always keep accurate, updated charts of the area on board your boat.
- Before you leave the port or harbor, file a float plan with a family member, relative, friend, or other responsible person ashore.
- Always operate your boat with care, courtesy, and common sense.
- Instruct at least one other passenger aboard in the operating procedures in handling your boat. This person can take over if you unexpectedly become unable to do so.
- Do not allow passengers to ride on parts of your boat other than designated seating areas.
- Ask all passengers to remain seated while the boat is in motion.
- Do not use the swim platform or boarding ladder while engines are running.
- Understand and obey the “Rules of the Road.” Always maintain complete control of your boat.
- Do not overload or improperly load your boat.

4.1.2 Safe Boating Courses

Your local U.S. Coast Guard Auxiliary and the U.S. Power Squadrons offer comprehensive safe boating classes several times a year. You may contact the Boat/U.S. Foundation at 1-800-335-BOAT (2628), or in Virginia 1-800-245-BOAT (2628). For a course schedule in your area, you may also contact your local U.S. Coast Guard Auxiliary or Power Squadron Flotilla for the time and place of their next scheduled classes.

4.1.3 Voluntary Inspections

State boating officials in many states or the U.S. Coast Guard Auxiliary offer courtesy inspections to check out your craft. They check your boat for compliance with safety standards and required safety equipment. You may voluntarily consent to one of these inspections and are allowed time to make correction without prosecution. Check with the appropriate state agency or the Coast Guard Auxiliary for details.

4.1.4 Rules of the Road

Navigating a boat is much the same as driving an automobile. Operating either one responsibly means complying with a set of rules intended to prevent accidents. Just as you assume other car drivers know what they are doing, other boaters assume you know what you are doing.

As a responsible yachtsman, you will comply with the “Rules of the Road”, the marine traffic laws enforced by the U.S. Coast Guard. There are two sets of rules: The United States Inland Navigational Rules and the International Rules. The United States Inland Rules apply to all vessels inside the demarcation line separating inland and international waters. The Coast Guard publishes the “Rules of the Road” in its publication “Navigational Rules, International-Inland.” You can get a copy from your local U.S. Coast Guard Unit or the United States Coast Guard Headquarters, 1300 E Street NW, Washington, D.C. 20226.

4.1.5 Safety Equipment

Not all models are provided with safety gear from the factory. Compliance with local regulations are the responsibility of the operator.

Important: Federal law requires you, the owner, to provide and maintain safety equipment on your boat. Consult your Coast Guard, state, and local regulations, to ensure your boat has all required safety equipment on board. Additional equipment may be recommended for your safety and that of your passengers. Make yourself aware of its availability and use.

On certain models, we have provided the following safety equipment in your Loose Gear Kit (Does not apply to UK boats):

- (6) Adult Form Life Vests (PID)
- (1) White Form Cushion
- (1) United States Coast Guard Pamphlet
- (1) Air Horn

4.1.6. Additional Equipment

You should consider having additional equipment on board to help make your boating experience safer and more enjoyable. Some examples include the following:

- Anchor and line *
- Boat hook
- Bucket & Sponge
- Commonly used spare parts
- Distress signal kit*

- Docking lines
- Engine and accessory manuals*
- Fenders
- First aid kit
- Flashlight & extra batteries
- Navigational charts
- Owner's Manual
- VHF radio
- Tool kit

4.1.7 Personal Flotation Devices (PFDs)

There must be one United States Coast Guard approved wearable personal flotation device of Type I, II, or III for each person on board your boat. The PFDs must be in serviceable condition and readily accessible. A minimum of three PFDs (two wearable and one throwable) is required regardless of the number of persons on board.

(A) PFD Type I, Wearable:

This offshore life jacket has the greatest buoyancy. It is effective for all waters where rescue may be delayed. Its design allows for turning most unconscious persons in the water from face down position to a vertical or face-up position.

(B) PFD Type II, Wearable:

This near-shore buoyant vest provides less buoyancy than a Type I PFD. It is intended for calm inland waters or waters where there is a chance of quick rescue. It turns its wearer to a face-up position as does the Type I PFD, but the turning action is not as pronounced as the Type I, and it will not turn as many persons under the same conditions as a Type I.

(C) PFD Type III, Wearable:

Classified as a flotation aid, this PFD allows wearers to place themselves in a vertical or face-up position in the water. Type III PFD has the same minimum buoyancy as a Type II PFD. It has little or no turning ability. People participating in water sports often prefer this PFD because it is intended for use in waters where quick rescue is possible and it is generally the most comfortable for continuous wear.

(D) PFD Type IV, Throwable:

You must also have aboard at least one throwable PFD

Type IV device. The Type IV device can be thrown to a person in the water and held by the user until rescued. The design does not allow it to be worn. The most common Type IV PFD are buoyant cushions or ring buoys. This PFD must be immediately available for use and in serviceable condition.

4.2 Carbon Monoxide Hazard

(See enclosed brochure concerning Carbon Monoxide poisoning and preventing)

As all responsible yachtsmen know, there are unseen dangers when boating. One danger is serious enough that we feel the need to specifically bring it to your attention. It is odorless, colorless, and tasteless, but can be harmful or fatal if inhaled. Its name is CARBON MONOXIDE (CO)

4.2.1 Carbon Monoxide Safety

This section is intended to provide educational information about carbon monoxide relative to boats and boating. Carbon Monoxide accumulation is affected by boat geometry, hatch, window, and door openings, ventilation openings, proximity to other structures and boats, wind direction, boat speed, boat maintenance, and a multitude of other variables. This section discusses many of these and enables the boat owner to better understand all conceivable variables. Therefore, the boat owner is cautioned not to exclusively rely on it to prevent the accumulation of Carbon Monoxide.

4.2.2 What is Carbon Monoxide?

Carbon Monoxide is a highly poisonous gas formed by the combination of carbon and oxygen. Commonly referred to as CO, its chemical formula is C for carbon and O for oxygen. CO is a colorless, odorless, and tasteless gas that, by itself, cannot be detected by human senses. CO diffuses in the air much more rapidly than other gasses that are detectable by the human senses. The weight of CO is about the same as air so it does not rise or fall like other gasses but will distribute itself throughout the boat. CO is produced any time a material containing carbon is burned. In boating, these materials include, but are not limited to, gasoline, diesel fuel, or propane. All carbon based fuels produce varying amounts of CO, depending on their carbon content. Gasoline is high in carbon and, therefore, produces lower levels of CO. However, the exhaust of all engines and generators as well as any

open flame device, produce CO and the same precautions should be taken regardless of the type of fuel.

4.2.3 How Carbon Monoxide Can Enter Your Boat

Any device that burns fuel creates Carbon Monoxide. For example, a propane cook-top or a space heater are both potential sources for CO. But the most serious danger comes from the gasoline engines and generators aboard your own and neighboring boats. There are four basic ways that CO from a running engine or generator can enter your boat.

The “station wagon effect” results from the aerodynamics of deck cabins and flying bridges. With the boat underway, the air flow over the top forms a low pressure area behind the cabin or transom which can suck exhaust gasses into the cockpit and the cabin inefficient trim angles also can cause the station wagon effect.

4.2.4 Symptoms of Carbon Monoxide Poisoning

Most important is to know the causes, study the symptoms, and be trained in the emergency care. This is the best way to avoid, understand, and respond to any Carbon Monoxide emergency:

One or more of the following symptoms can signal the adverse effects of Carbon Monoxide accumulation. The order of this list is generally the sequence of symptoms. However, the number of symptoms and the order of their appearance may change for different people.

Watering and Itching eyes
Tightness in the chest
Flushed Appearance
 ringing in the ears
Throbbing Temples
Inattentiveness Convulsions
Drowsiness
Headache
Dizziness
Vomiting
Collapse
Nausea
Fatigue

4.2.5 Effects of Carbon Monoxide

When inhaled, Carbon Monoxide is absorbed by the lungs and reacts with the blood hemoglobin to form carbon hemoglobin, which reduces the oxygen carrying

capacity of the blood. The result is a lack of oxygen for the tissues, causing subsequent tissue death and, if prolonged, death of the individual. Carbon Monoxide in high concentrations can be fatal in a matter of minutes. Even lower concentrations must not be ignored because the affects of exposure to CO are cumulative and can be just as lethal. Certain health related problems and age increases the effects of CO. People who smoke or are exposed to high concentrations of cigarette smoke, consume alcohol, or have lung or heart disorders are particularly susceptible to an increase in the effects from CO. However, the health of all of the boat’s occupants should be considered. Physical exertion accelerates the rate at which the blood absorbs CO. The early effects of CO poisoning are easy to overlook because they are similar to the effects of other boating related stress such as eye strain, fatigue, sun exposure, seasickness, or alcohol consumption. But, as the concentration of CO in the air increases, it has increasingly adverse effects on your health.

4.2.6 When Overcome by Carbon Monoxide

When someone falls victim to Carbon Monoxide poisoning, fast and responsive action is crucial. Know the symptoms. The earlier the effects of CO are detected, the better the chances for recovery. The following list shows the sequences of events that must be done in an effort to revive a CO victim:

- Evacuate, Ventilate, Investigate, complete the Carbon Monoxide poisoning action sequence
- Move the victim to fresh air.
- Administer oxygen if available. If the victim is not breathing, perform artificial resuscitation per approved CPR procedures until medical help arrives and takes over. Prompt action can mean the difference between life and death.
- Ventilate the area.
- Investigate the source of CO and take corrective action.
- As always, you can contact the Red Cross to obtain information for training in CPR or emergency response care.

4.2.7 How to Minimize the Accumulation of Carbon Monoxide

Practice good inspection and maintenance habits. Be certain hull exhaust outlets are not blocked or restricted in any way.

Be alert for exhaust gasses from other boats. Always

provide adequate ventilation when weather enclosures are in place and engines or generator is running.

Do not run with a high bow angle. Use trim tabs or redistribute the load to maintain a low bow angle. Orient your boat to maximize the dispersion of CO.

We cannot identify or describe every possible variable or combination of variables, you must continually observe passengers for symptoms or Carbon Monoxide intoxication and be aware of the many possibilities of Carbon Monoxide accumulation. For instance, poorly maintained hoses and hose connections on the generator or engine exhaust system(s) can permit Carbon Monoxide to escape into the interior of your boat. Therefore, the exhaust system must be periodically examined and maintained in order to ensure its integrity. Moreover, all accommodation spaces constantly require proper ventilation.

4.2.8 Preventative Maintenance

Frequent inspections and proper maintenance of the engine, and exhaust system, as well as, other various areas of your boat are critical in preventing the accumulation of Carbon Monoxide. It is the owner's responsibility to make sure the entire boat is inspected and maintained against CO.

The exhaust systems of your engines and generator are under constant attack from salt water, gasses, vibration, and normal wear. Inspect every exhaust system component often. Start with a visual inspection. Check each joint for discoloration, carbon buildup, stains, water leaks, or other signs of damage. Inspect all metal parts for corrosion, discoloration, or flaking. Check that all hose clamps are in good condition and properly tightened. Carefully inspect all exhaust and cooling hoses for signs of wear, dry rot, cracking, discoloration, chafing, or swelling. If any of these conditions exist, have the entire system inspected and corrected by a qualified technician before starting the engines or generator.

Next, start each engine and generator one at a time. Follow the full run of the exhaust system, listening and looking for leaks. While doing this, make sure there is adequate ventilation and that your CO detector is on.

Other items to inspect are as follows: If your boat has access panels, check that the access panels around the engine and exhaust are in place and fit snugly to minimize the opportunity for CO to enter the cabin. There should be no large openings where CO could enter the

cabin. Ensure that all ventilation systems are in good working order and are not blocked or punctured. Check all sink drains to assure that they have a good water trap to prevent CO from coming in from the outside.

Finally, because poorly running engines produce excessive CO, make sure engines and generators are tuned up. They should run smoothly and not produce black smoke. The spark plugs (gas engines) and ignition systems should be maintained regularly, and the fuel system and air filters should be in good order.

4.2.9 Carbon Monoxide Detectors

If you carefully avoid potential CO accumulation and maintain your systems properly, you have made great strides towards protecting yourself and others from the dangers of Carbon Monoxide. We have assisted you in your endeavor by providing CO detectors in each living area aboard your boat. We use only those CO detectors that are UL approved for marine use. RV and residential models won't withstand the elements of the boating environment. Most CO detectors require specific maintenance procedures to remain accurate and functional. Follow the manufacturer's instructions for the use and maintenance of the CO detectors.

It's strongly recommended that you change CO and Smoke alarm batteries when changing the clocks for Daylight-Saving Time. **Replace Smoke Alarms every 10 years and replace Carbon Monoxide (CO) alarm every 5 years** since the sensors in these devices can degrade because of environmental contamination and from age. In addition to replacing batteries in smoke alarms at least once every year. Always make sure the followings:

1. Smoke/CO alarms should be tested monthly to make sure they are working in your boat.
2. Batteries should be changed once a year, when changing the time on clocks of your boat.

"A working smoke alarm can save lives. It's that simple and that important,"

If you would like to purchase additional CO detectors and receive a special purchase price, please contact our Customer Service Hotline at 800-771-5556,

On the next couple pages we will review some of the CO hazards.

4.2.10 Carbon Monoxide Review

Know the Dangers!



Swimming near or under the back deck or swim platform. Carbon monoxide from exhaust pipes of inboard engines, outboard engines and generators build up inside and outside the boat in areas near exhaust vents. **STAY AWAY** from these exhaust vent areas and **DO NOT** swim in these areas when the motor or generator is operating. On calm days, wait at least 15 minutes after the motor or generator has been shut off before entering these areas. **NEVER** enter an enclosed area under a swim platform where exhaust is vented, not even for a second. **It only takes one or two breaths of the air in this “death chamber” for it to be fatal.**

Blockage of exhaust outlets can cause carbon monoxide to accumulate in the cabin and cockpit area - even when hatches, windows, portholes, and doors are closed.

Exhaust from another vessel that is docked, beached, or anchored alongside your boat can emit poisonous carbon monoxide gas into the cabin and cockpit of your boat. Even with properly vented exhaust, your boat should be a minimum of 20 feet from the nearest boat that is running a generator or engine.

Slow speeds or idling in the water can cause carbon monoxide gas to accumulate in the cabin, cockpit, bridge, and aft deck, even in an open area. A tailwind (force of wind entering from aft section of the motorboat) can also increase accumulation.

The “station wagon effect,” or backdrafting can cause carbon monoxide to accumulate inside the cabin, cockpit, and bridge when operating the boat at a high bow angle, with improper or heavy loading or if there is an opening which draws in exhaust.

This effect can also cause carbon monoxide to accumulate inside the cabin, cockpit, aft deck, and bridge when protective coverings are used and the boat is underway.

Teak surfing, dragging and water-skiing within 20 feet of a moving watercraft can be fatal.

D

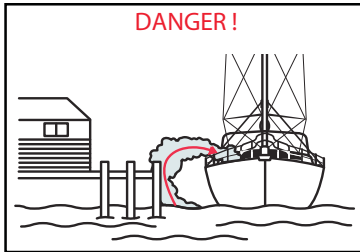

Moored to pier blocking exhaust!

Figure 4.3. Blocked hull exhaust outlets near a pier, dock, seawall, bulkhead or any other structure can cause excessive accumulation of Carbon Monoxide gas with the cabin areas of your boat. Be certain hull exhaust outlets are not blocked in any way.

A

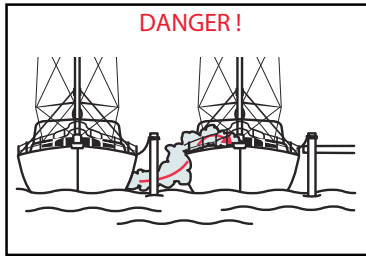

Exhaust from other vessels moored alongside!

Figure 4.4. Engine and generator exhaust from other vessels alongside your boat, while docked or anchored, can cause excessive accumulation of Carbon Monoxide gas within the cabin and cockpit areas of your boat. Be alert for exhaust from other vessels.

N

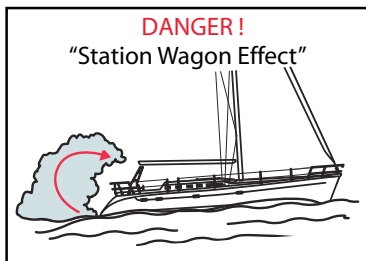

Caused by high bow angle!

Figure 4.5. Engine or generator exhaust from your boat while underway and operating with a high bow angle can cause excessive accumulation of Carbon Monoxide gas within the cabin and cockpit areas of your boat. Always provide adequate ventilation and redistribute the load to lower the boat angle.

G

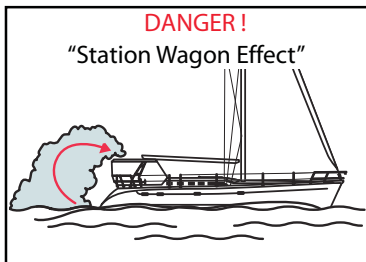

With protective coverings in place!

Figure 4.6. When protective weather coverings are in place, engine or generator exhaust from your boat, while docked and/or running, can cause excessive accumulation of Carbon Monoxide gas within the cabin and cockpit areas of your boat. Always provide adequate ventilation when the weather coverings are in place and either the engine or generator are running.

E

R

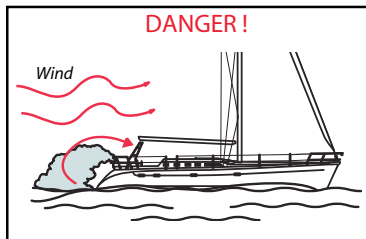

Slow speed, idle, or wind!

Figure 4.7. While underway or drifting slow speed can cause CO buildup, add a tailwind and this can intensify the effect.

Everyone is at risk for Carbon Monoxide poisoning! Particularly sensitive are children, pregnant women, the elderly, and people with lung disease, heart disease, or anemia!

WHY? Because Carbon Monoxide is an odorless, colorless gas that prevents the blood from carrying oxygen to the vital organs. CO (Carbon Monoxide) is 200 times more likely to replace oxygen in the blood.

Check the symptoms of Carbon Monoxide poisoning in this chapter (4.2.4) again right now, so you will be able to recognize these symptoms should they ever arise.

! DANGER !

Mild Exposure	100 – 400 PPM (parts per million)	causes headaches and fatigue resembling the flu.
Medium exposure	400 – 800 PPM	causes severe headaches, drowsiness, nausea, and rapid heart rate.
Extreme exposure	over 800 PPM	results in unconsciousness, convulsions, heart or respiratory failure, and death.

Many reported cases of Carbon Monoxide poisoning determined that while victims are aware they are not well, they become so disoriented, they are unable to save themselves by either exiting the building or calling for assistance. Also, children and pets may be affected first.

Carbon Monoxide gas is produced when any type of fuel is incompletely burned. Gasoline engines and fuel burning appliances (furnace, fireplace, oven, stove, water heater, etc.) also, space heaters, gas, and charcoal grills produce CO.

Extended operation of unvented fuel burning appliances (range, oven, fireplace, etc.) can build up high CO levels.

! CAUTION !

This alarm will only indicate the presence of Carbon Monoxide gas at the sensor. Carbon Monoxide gas may be present in other areas.

! WARNING !

To reduce the risk of Carbon Monoxide poisoning, test

the alarm's operation after the boat has been in storage, before each trip, and once a week during use.

- DO NOT attempt to test the alarm by any other means than by using the Test/Reset button.
- DO NOT attempt to produce CO to test the alarm. The Test/Reset button tests all functions of the alarm and is the only safe way to be sure the alarm is working properly.

Once again, here and now, check in the DC Electric chapter on the operation of your CO detector. Learn how to use it, how it works, what the alarm signals are, and what your response should be.

! DANGER !

Actuation of your CO alarm indicates the presence of Carbon Monoxide (CO) which will KILL YOU! If the alarm sounds:

1. Press the Reset/Silence button.
2. Call Emergency Services: Write the number here _____.
3. Immediately move to fresh air, outdoors, or to an open window or door. Do a head count to check that all persons are accounted for. Do not re-enter the premises nor move away from an open door or window until the emergency responders have arrived, the premises have been aired out, and your alarm remains in its normal operation.
4. After following steps 1, 2, and 3, if your alarm reactivates in a 24 hour period, repeat steps 1 – 3 and call a qualified appliance technician:
Write the number here _____

Where to Install Alarms:

- For minimum protection, CO alarms should be installed near all sleeping areas.
- For maximum protection, CO alarms should be installed in all sleeping areas.
- Where not to Install Alarms:
 - Not behind furniture, drapes, closets, or areas that will block air flow to the alarm.

- Not within 12 inches of window openings, exterior doors, heating or return air vents, or any other drafty areas.
- The alarm should not be located within 5 (1.5 m) feet of any cooking appliance.
- For information on taking care of your CO alarm, see the Maintenance chapter of this manual.

Limitations of the CO alarm:

Carbon Monoxide alarms will not work without power. Some examples causing no alarm power are: A blown or missing fuse, broken wire, faulty connection, circuit breaker tripped, or a discharged battery.

This alarm will only detect the presence of CO gas at the sensor. Carbon Monoxide gas may be present in other areas.

Carbon Monoxide alarms may not be heard. The alarm loudness is designed to meet or exceed the regulatory standards. However, the alarm may not be heard if alarms are located in remote locations or behind closed doors. The alarm may not be heard by persons who are hard of hearing, have consumed alcoholic beverages, taken prescription or non-prescription medication, or illegal drugs.

This alarm is designed to detect Carbon Monoxide from any source of combustion. It is not designed to detect smoke, fire, or any other gasses. The alarm may not sound at low Carbon Monoxide levels. This product is intended for use in ordinary indoor locations of living spaces. It is not designed to measure compliance with Occupational Safety Health Administration (OSHA) commercial or industrial standards. Individuals with medical problems may consider using warning devices which provide audible and visual signals for levels under 30 PPM.

How else to protect your family from Carbon Monoxide:

Ensure alarms are installed properly. Carefully read and follow ALL the instructions in this manual. Test your unit every week. Alarms that do not work, do not alert you to the presence of Carbon Monoxide.

Make regular visual inspections of all fuel burning equipment including gas water heaters, kitchen gas stoves, space heaters, gas dryers, or other pilots. Check the color of the flame! The color should be blue.

Make regular visual inspections of the engine and generator exhaust systems. Cracked exhaust systems can allow Carbon Monoxide to enter the living area.

Professionally maintain your engine and generator. Although all gas engines and generators produce Carbon Monoxide, a poorly tuned engine and generator will produce greater amounts of Carbon Monoxide.

4.3 Other Dangers

4.3.1 Weather

Storms rarely appear without advanced notice. Check the weather forecast before you begin a day of boating. Be aware, however, that weather conditions can change rapidly. If you have a marine radio, listen to the weather reports issued by the U.S. Coast Guard and others. If you have a portable radio, keep it tuned to a station broadcasting frequent weather reports. Many boating clubs fly weather signals. Learn to recognize these signals and listen to your local forecasts before leaving port.

Your surroundings can also be a good indicator of changing weather conditions. Watch for changes in wind direction or cloud formations. There is no substitute for a good understanding of weather conditions and what to do when the weather takes a turn for the worse.

Page 4.15 will explain the dangers of Lightning strikes, with an overview of your protection area.

- Refer to the Chapman's Manual for instructions and precautions in operating a craft in heavy weather.

4.3.2 Fog

You can judge the likelihood of fog formation by periodically measuring the air temperature and the dew point temperature. If the difference between these two temperatures is small, fog is likely to develop.

Foggy conditions include mist, snowstorm, or heavy rain.

Avoid operation in such weather, especially if your boat is not equipped with radar or other

4.3.3 Remember these guidelines:

- Unless your boat is well equipped with charts, head for shore at the first sign of fog and wait until conditions improve. If you have charts on board, take bearings as fog sets in, mark your position, and continue to log your course and speed.
- Make sure all persons on board are wearing their personal flotation devices (PFDs). If your boat has sounding equipment, take soundings regularly and match them with known depths on your charts.
- Station a person forward in the boat as a lookout.
- Reduce your speed. From time to time, stop engines and listen for other fog signals.
- Sound the horn or bell at approximately 2 minute intervals.
- If there is any doubt about continuing your excursion, anchor. Listen for other fog signals while continuing to sound your fog horn.

4.3.4 Drugs and Alcohol

Drugs and alcohol affect a person's ability to make sound judgments and react quickly. As a responsible boater, you will refrain from using drugs or alcohol (singly or combined) while operating your boat. Operation of motorized vessels while under the influence carries a significant penalty. Drugs and alcohol decrease your reaction time, impair your judgment, and inhibit your ability to safely operate your boat.

4.3.5 Collision

If a serious collision occurs, first check the persons on board for injuries. Then inspect the boat to determine the extent of the damage.

Prepare to help the other craft unless your boat or its passengers are in danger.

Prepare to help the other craft if your bow penetrated the other boat or its passengers are in danger.

If the bow of the other boat penetrated your boat's hull, prepare to plug the fracture once the boats are separate.

4.3.6 Running Aground

If your boat runs aground, check everyone for injury and inspect damage to the boat or propellers. If lightly grounded, shift weight of passengers or gear to heel the boat while reversing engines. If towing becomes necessary, we recommend using a commercial towing service.

4.3.7 Swamped or Capsized Boat

If your boat becomes swamped or capsized, put on a PFD immediately and set off a distress signal. Your boat has flotation foam installed to keep it afloat should it capsize. For this reason, stay with the boat. Do not leave the boat or try to swim to shore except under extreme conditions. A capsized boat is easier to see than a swimmer, and shore may be further away than it appears.

4.3.8 Falling Overboard

One of the most frightening emergencies that can occur aboard a boat is a crew member or yourself falling overboard. Although "man overboard" or "MOB" drills have been a part of boating safety for decades, they have been largely overlooked by many responsible boat owners.

Just as important as acquiring the knowledge to rescue a person is the ability to help yourself if you are the person overboard. Be sure and refer to your "Chapman Piloting", "Seamanship and Boat Handling" manual supplied with your new boat. It is packed with useful and essential safety and emergency procedures to ensure you have a safe and happy boating experience.

4.3.9 Hypothermia

If a person falls overboard, hypothermia may be an immediate concern. Hypothermia means a person's body loses heat to the water faster than the body can replace it. If not rescued, the person will become exhausted and likely drown. In general, the colder the water, the shorter the time for survival. PFDs will increase survival time because they provide insulation.

Water Temperature	Exhaustion or Unconsciousness	Expected Time of Survival
32.5	Under 15 min	Under 15 to 45 min
32.5 – 40	15 – 30 min	30 – 90 min
40 – 50	30 – 60 min	1 – 3 hrs
50 – 60	1 – 2 hrs	2 – 4 hrs
60 – 70	2 – 3 hrs	2 – 4 hrs
70 – 80	3 – 12 hrs	3 hrs – indefinite
Over 80	Indefinite	Indefinite

4.4 Fire



A fire aboard your boat is serious. Explosion is possible. Respond immediately. Develop a fire response plan.

4.4.1 Fire

Every boater should develop a fire response plan to determine what kind of fire (fuel, electrical, etc.) might break out, where it might break out, and the best way to react.

Important: Everyone on board should know where a fire extinguisher is and how to operate it.

Any fire requires stopping the engines immediately.

Keep the fire downwind if possible. If the fire is aft, head into the wind.

Have all persons on board put on their personal flotation devices (PFDs).

If you can get at the fire, aim the fire extinguisher at the base of the flames and use a sweeping action to put out the fire.

If the fire gets out of control, make a distress signal and call for help on the radio.

Deciding whether to stay with the boat or abandon ship will be difficult. If the decision is to abandon ship, all persons on board should jump overboard and swim a safe distance away from the burning boat.

4.5 Distress Signals

4.5.1 Mayday

If you have a VHF radio, heed storm warnings and answer any distress calls from other boats. The word “MAYDAY” spoken three times is the international signal of distress. Monitor marine radio channel 16, which is reserved for emergency and safety messages. You can also use this channel to contact the Coast Guard or other boaters if you have trouble.

Never send a “MAYDAY” message unless there is a serious emergency and you are in need of immediately assistance.

4.5.2 Visual Distress Signals

The U.S. Coast Guard requires that all boats operating on U.S. Coastal Waters have visual distress signal equipment on board. In general, coastal waters include all waters except rivers, streams, and inland lakes. The Great Lakes are considered coastal waters, as is a river mouth more than two miles wide. Boats owned in the United States and operating on the high seas must also carry visual distress signal equipment.

Visual distress equipment must be in serviceable condition and stowed in a readily accessible location. Equipment having a date showing useful service life must be within the specified usage date shown. Both pyrotechnic and non-pyrotechnic equipment must be U.S. Coast Guard approved.

Pyrotechnic U.S. Coast Guard approved visual distress signals and associated equipment include: Red flares, handheld or aerial Orange smoke, hand held or floating Launchers for aerial red meteor or parachute flares. Non-pyrotechnic equipment includes an orange distress flag, dye markers, and an electric distress light.

No single signaling device is ideal under all conditions for all purposes. Consider carrying various types of equipment. Careful selection and proper stowage of visual distress equipment is very important. If young children are frequently aboard, you should select devices with packages which children, but not adults, will find difficult

to open.

Other helpful publications available from the U. S. Coast Guard include “Aids to Navigation” (U.S. Coast Guard pamphlet #123), which explains the significance of various lights and buoys, the “Boating Safety Training Manual”, and “Federal Requirements for Recreational Boats”. Check with your local Coast Guard Station, your new dealer, or a local marina about navigational aids unique to your area.

4.5.3 Running and Navigation Lights

Your boat is designed as a "day sailor" and therefore is not provided with running and navigation lights for safe operation after dark. Always use common sense and good judgment.

The following is presented for reference only since your boat is not designed to be used after dark.

Operating at night can present some special challenges. Not only is your depth perception lessened, bright lights on the shore can cast misleading reflections on the water and if you wear glasses, or worse yet, bifocals, you simply don't see as well at night as you do during the day. It is not only important that you be able to identify other vessels operating in your proximity, it is equally important that other vessels see you. Most recreational vessels are less than 30 feet in length and, according to “The Rules of the Road”, shall be equipped with navigation lights. These lights not only have a certain arc through which they can be seen but must be seen from a minimum distance. Table 1, on page 4.14 will show you the following lighting requirements for recreational vessels both less than 12 meters in length (approximately 39.4’), and over 12 meters in length to 20 meters (65’)

Light	Arc	Color	Visible Range
Masthead Light	225	Wht	2
Starboard	112.5	Grn	1
Port Sidelight	112.5	Red	1
Sternlight	135	Wht	2

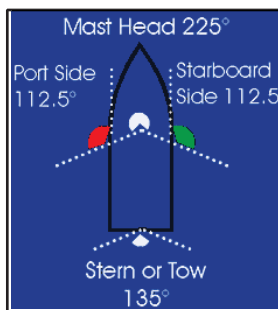

The arc of the lights and color allows you to determine the direction a vessel is moving. How good are your lights? You should test them to see how visible you might be at night. Whether on a trailer or at the marina, switch on your lights and see how well they can be seen. Walk

away from the boat or row away, if you are at anchor or at a mooring, and see how visible the lights are as you move further away. How easy are they to see against the background of lights on shore?

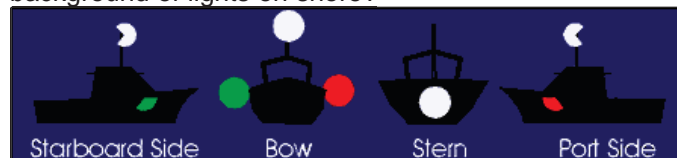

You should always check that your masthead light disappears at the same time each sidelight disappears and they both disappear when the stern light appears.

Check your sidelights from dead ahead. You should see both red and green. However, by moving toward one side by 1-3 degrees, you should then see only one light. If you still see two lights, an approaching vessel won't be able to tell which direction you are going.

When boating at night, remember the following: “When two lights you see ahead, turn your helm and show your red.”

4.5.4 Sound Signaling Device

Your boat is provided with a horn which conforms with U.S. Coast Guard requirements for boats of this size. All class A boats are recommended to carry a hand, mouth, or whistle, as well as a power operated horn. The device should be used to promote safe passing, as well as a warning to other vessels in fog, or confined areas, or as a signal to operators of locks or drawbridges. Following are standard whistle signals:

One Prolonged Blast	Warning Signal
One Short Blast	Pass on my port side
Two Short Blasts	Pass on my starboard side
Three Short Blasts	Engines in Reverse
Five or More Blasts	Danger Signal

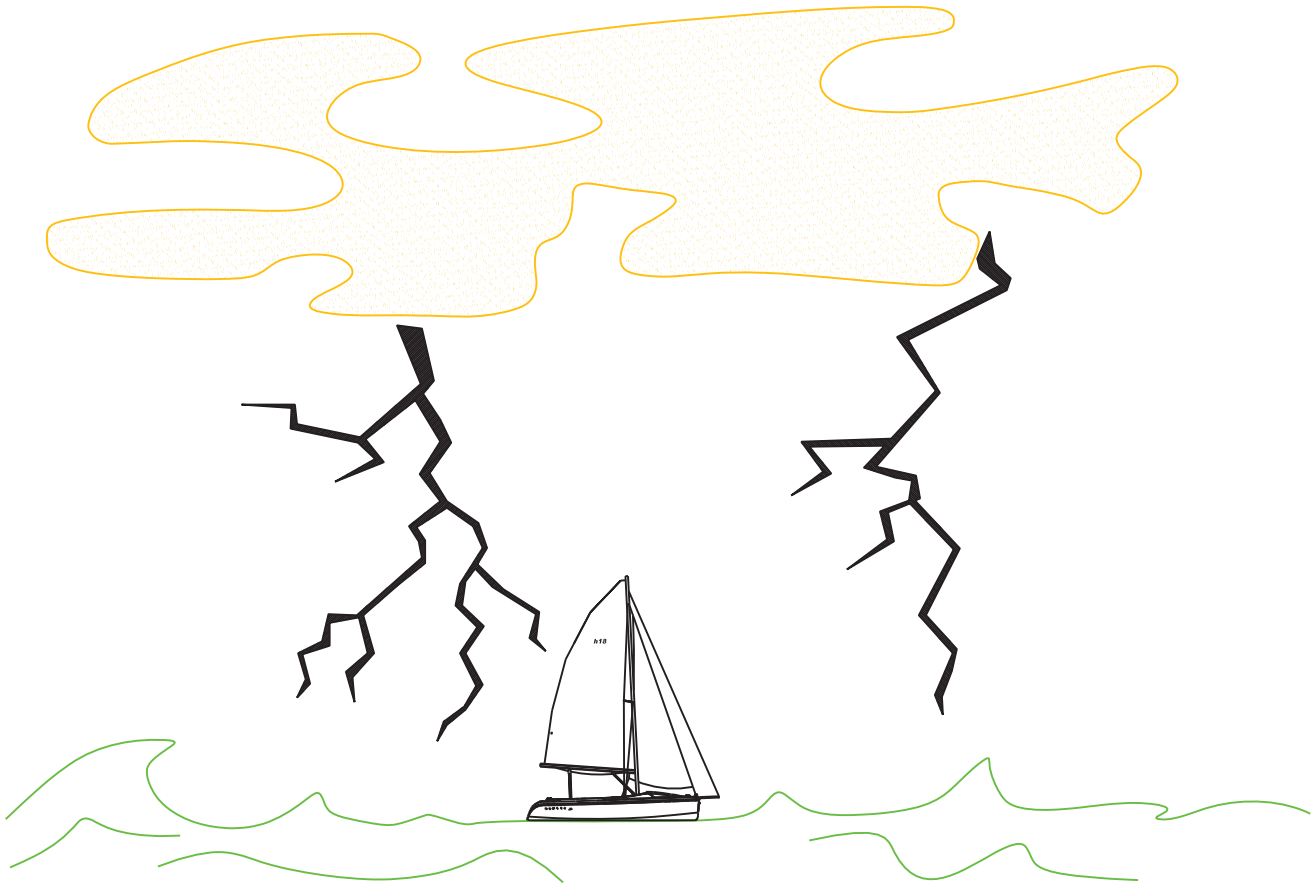

LIGHTNING STORM WARNING:

- 1. DO NOT OPERATE YOUR BOAT IN WEATHER WHERE LIGHTNING MAY BE PRESENT.**
- 2. PRECAUTIONS: DURING LIGHTNING STORMS: A. SEEK IMMEDIATE SHELTER. B. OCCUPANTS SHOULD NOT HAVE ANY BODY PARTS IN THE WATER. C. AVOID CONTACT WITH ANY METAL OBJECTS.**

FAILURE TO FOLLOW PRECAUTIONS MAY RESULT IN SEVERE INJURY OR DEATH

Deck Arrangement

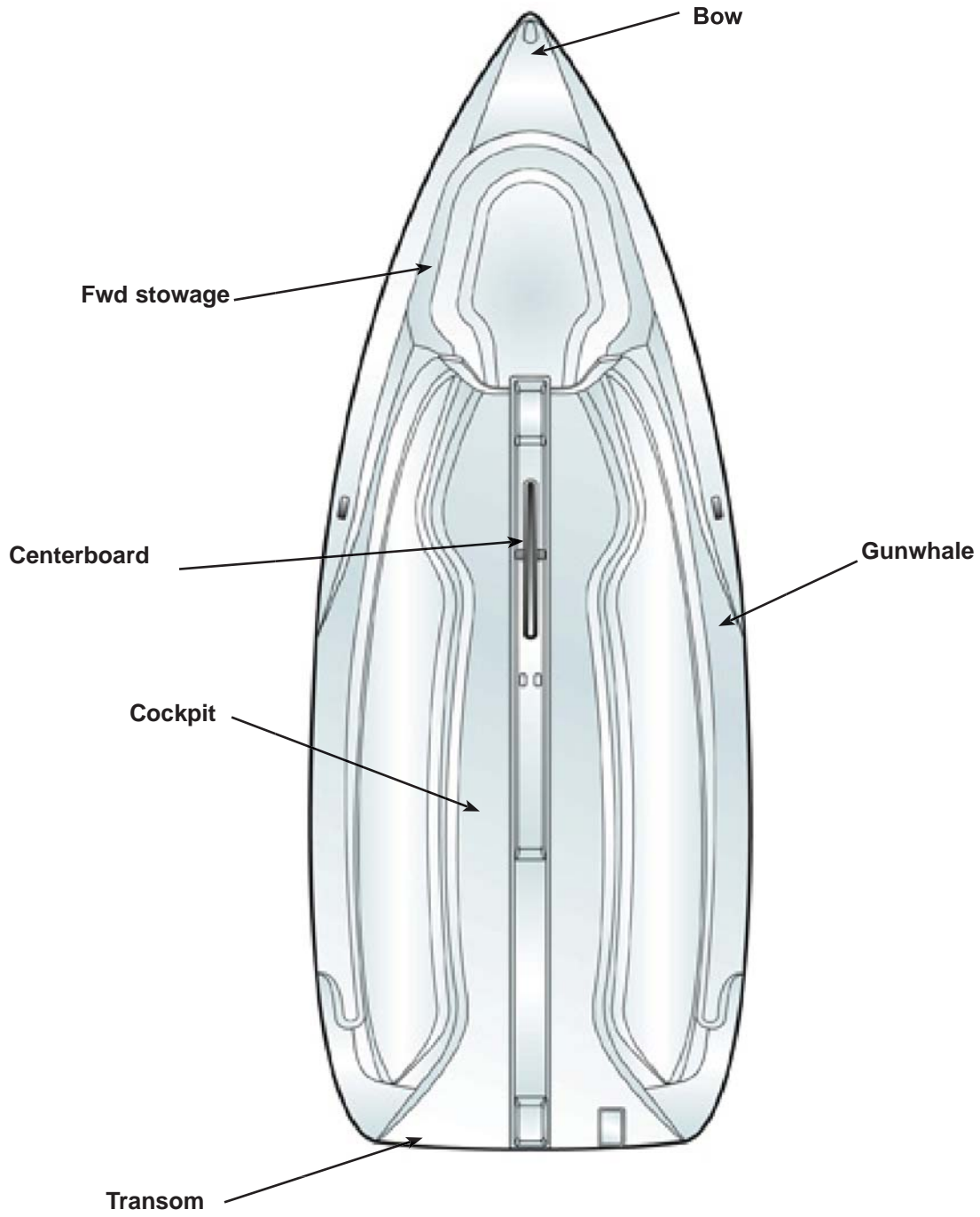

General Boat Arrangements

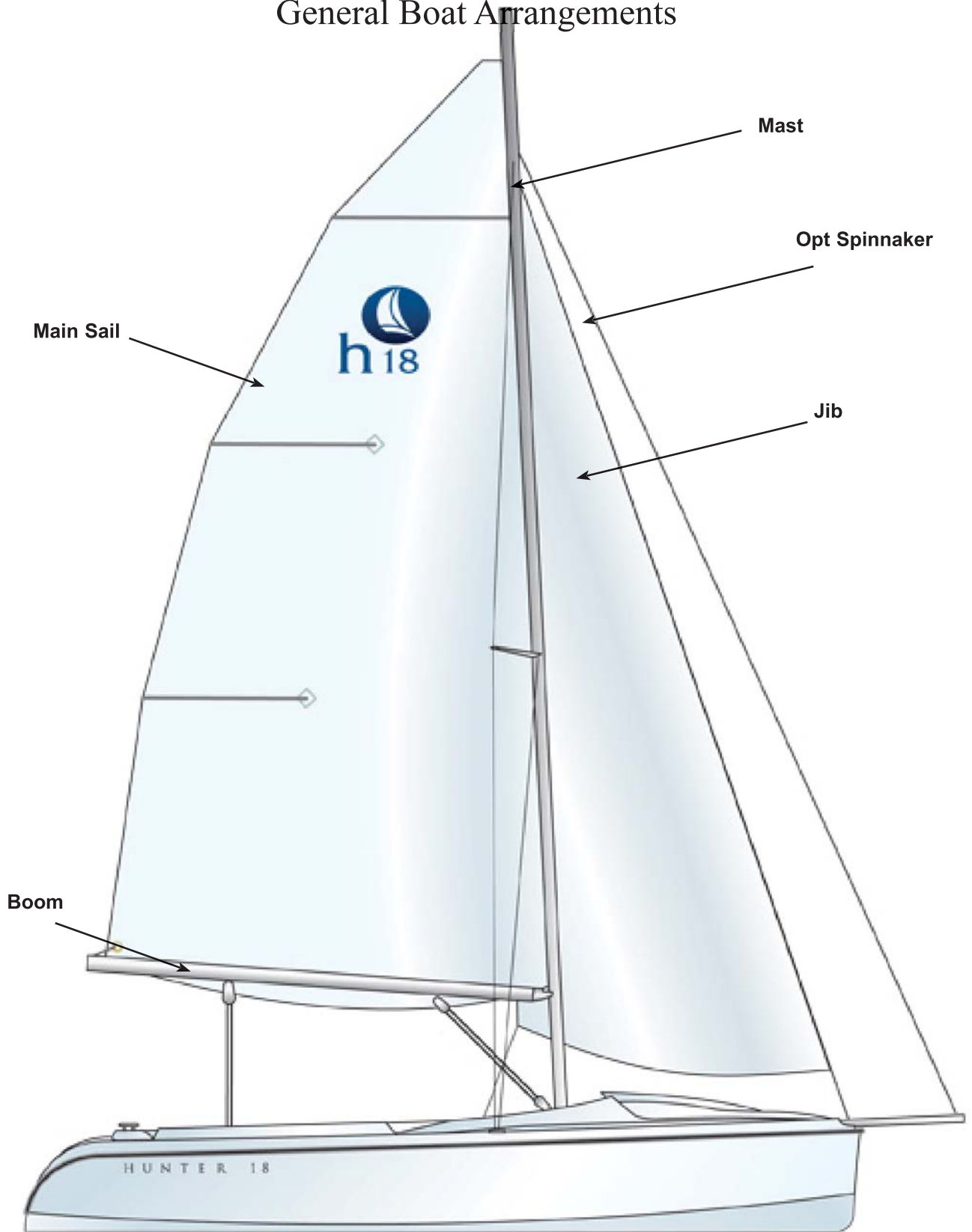

H18 Dimensions, Capacities, Etc.

DESCRIPTION:	H18
Length overall (LOA).....	18' 5" (5,61m)
Beam (MAX).....	7' 2" (2.18m)
Draft centerboard up.....	6" (114 mm)
centerboard down	4' 6" (1371mm)
Displacement.....	836lbs (380 kg)
Sail Area (total).....	170sq. ft (15.8 sq.m)
Mast height (waterline).....	24.5' (7.5m)
Engine (not supplied) size recommendation..	3 H.P. MAX (2.2 kW)
Maximum loading (Persons/Luggage).....	4 Persons + luggage = 760 lbs. (345 kg.)

Deck Hardware

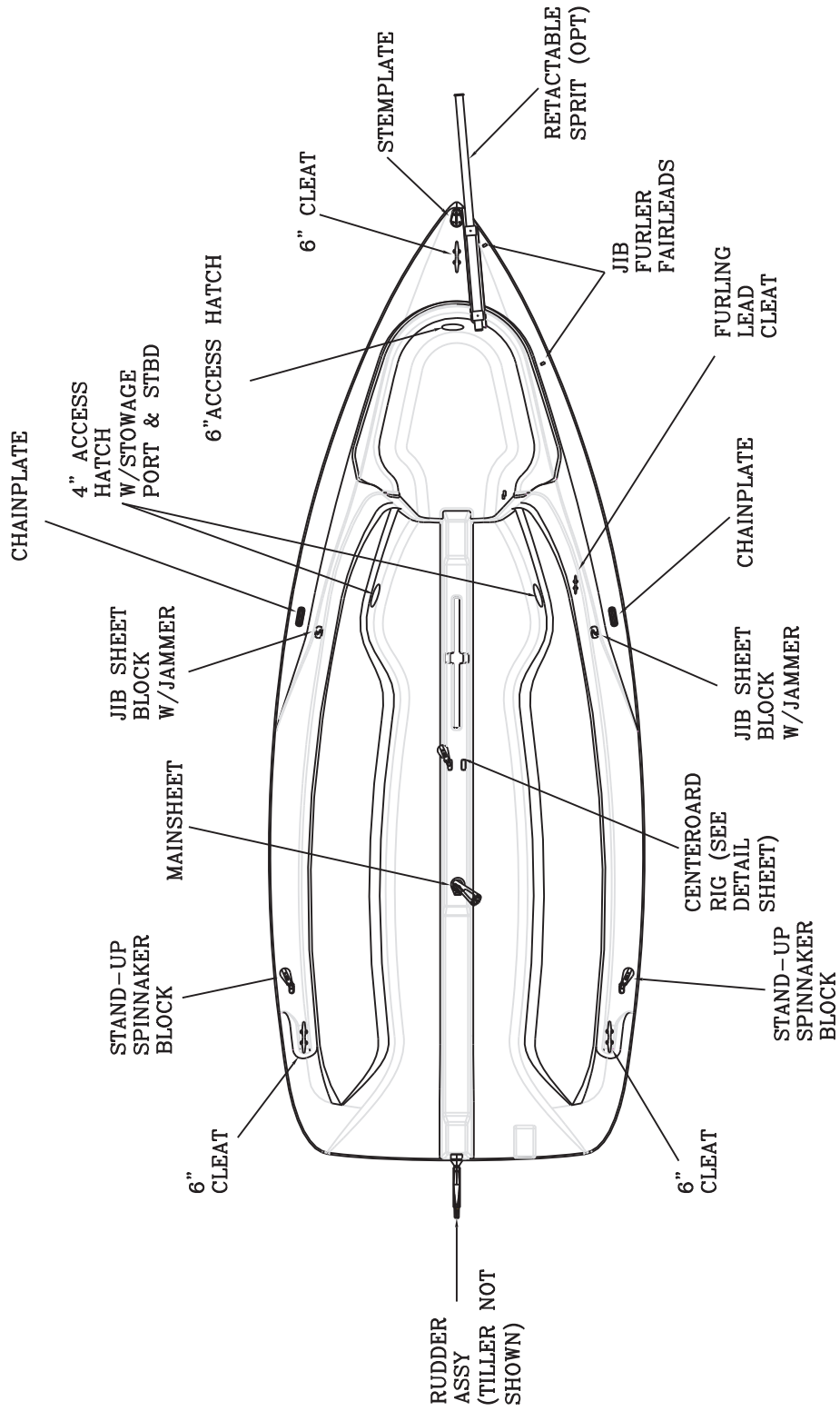

THIS PAGE INTENTIONALLY LEFT BLANK



HUNTER®

MARINE CORPORATION

AN EMPLOYEE OWNERSHIP COMPANY

We Go The Distance

Chapter 5

***Sails
and
Rigging
H18***



Sails & Rigging

Most sailors believe that sailing is hard work: all those lines to tend, halyards to yank and sails to lug. Hunter Marine has dispelled that myth once and for all! Innovations by the crew at Hunter Marine have made sailing easier, safer and more comfortable. The result - much more sailing fun!

Whether you are ready to set sail for the day or just around the buoys, your Hunter can really make a difference. Starting with the tall, fractional rig, which is a direct descendent of the B&R rig, Hunter has engineered the mast to carry less weight aloft with a smaller sections. This is accomplished by utilizing swept-back spreaders and reverse diagonals. This combination provides superior strength without a backstay and increases the stability at the same time. By using a large roach main as the power sail, Hunter has eased the effort in sail handling and allowed for real versatility for all wind and sea conditions.

Your benefit: better performance with less effort. The deck layout reflects the innovation that accompanies the rig.



Refer to Boating Safety, and the Getting Underway chapters for safe boat handling information.

If this is your first boat of this type or you are changing to a new boat you are not familiar with, please ensure that you obtain handling and operating experience before assuming command of the boat. This document is not a course on boating safety or seamanship. Your dealer or national sailing federation or yacht club will be pleased to advise you of local sea schools, or competent instructors.

Never underestimate the potentially dangerous power of wind, tide and the sea. Always ensure there is sufficient trained and proficient crew on board to handle the boat and its operating systems even in adverse conditions.

NOTE: Standing rigging will stretch slightly when initially loaded. Therefore, the rigging may have to be further tensioned slightly after a few sails in a strong breeze to compensate for this initial stretch. Once the mast is tuned and initial stretch is taken out, the rig should need retuning only at the beginning of each season.

5.1 Main Rig Components

- Anodized B&R Rig Mast
- Boom
- Single Line Reefing System
- Furling Jib
- Internal Halyards led to Cockpit
- Large Roach Mainsail w/Flaking System
- Mainsheet and vang

Over the course of the next few pages we will outline some of the components featured here, along with some of the optional components of your sails and rigging aboard your Hunter sailboat.

5.2 The Mast

Your main and most vital rig component is the mast. It carries the sails and is supported by the standing rigging as shown on page 12.11.

5.3 The Boom

The boom carries the lower sheeting point of your main sail and is controlled by the main sheet and the vang. Page 4.12 contains illustrations demonstrating the boom with reefing layout and the Mainsheet Purchase layout.

5.4 The Sails

As standard your Hunter is equipped with a furling jib sail and a drop down main sail. The mainsail is the sail attached to the aft track of the mast and hoisted with the main halyard from the cockpit. The jib sail is attached to the forestay and like the mainsail hoisted with the jib halyard from the cockpit.

Most Hunter sailboats feature the control of the most important sail controls from the cockpit. The jib is controlled with the jib sheet control lines lead back to the cockpit coming either side. In addition the jib furling line located to the starboard side of the cockpit allows the safe and easy unfurling and furling in of the jib sail.

5.5 Reefing Instructions

1. Run reefing line as illustrated in the boom & reef layout.

2. Ease the mainsheet and vang.
3. Raise the main sail.
3. Check the topping lift for adequate boom support and lower the main sail to approximately the first reef position.
5. Take up the slack in the reef line until the tack and the clew are down to about 2" above the boom.
6. Adjust the main halyard so that the tack reef point is not contacting the goose neck on the front of the spar and is applying tension to the luff of the main above the reef, not below.
7. Confirm that the tack reef point is still clear of the tack shackle and that only the main luff above the reef cringle is tensioned, not the luff between the cringle and the top stacked sail slide. Ease the reef line and readjust the halyard if necessary.

5.5 Shaking Out a Reef

1. Head up into the wind.
2. Ease the mainsheet and vang. Release the tension on the topping. Lift (if needed).
3. Release the line stopper.
4. Tension the main halyard to raise sail, making sure reef lines run freely while sail is being raised. Apply stopper to main halyard.
5. Re-tension vang and mainsheet, ease the topping lift (if needed).

5.6 Spinnaker (Optional)

To set the optional spinnaker using the dedicated halyard, first attach the halyard to the head ring on the sail. Next, tie the tack downhaul line to the tack ring, lead it through the sprit to the jamming cleat in the cockpit near the mast. Set up the tack downhaul so the tack of the sail is about five inches above the deck when the sail is hoisted. Attach the spinnaker sheet to the clew ring of the spinnaker and make sure the line is led aft outside the

lifelines to a turning block on the gunwhale located just forward of the stern cleat. The sheet that is not being used — the lazy sheet — should also be attached to the clew of the spinnaker, led forward *in front of the headstay*, and then back on the other side of the boat — outside the shrouds — to the turning block positioned just forward of the stern cleat. Then take that sheet and tie a knot in the end, with the slack in the sheet. Now you are ready to hoist the spinnaker. Start by heading off to a square run. Leave the mainsail fully out during the hoisting procedure as it will blanket the spinnaker and keep it from filling until you are ready for it to be set. A good place to raise the sail is from the leeward side, just ahead of the boom. Once it is fully hoisted, slowly head up to your desired course and pull in the sheet until the sail sets. Now you are off and sailing with your cruising spinnaker.

H18 B&R Rig Description

The B&R rig, utilized on the Hunter 18, eliminates the need for a backstay to allow for a more efficient mainsail shape. Fixed backstays are commonly being designed out of today's performance-oriented boats to allow the mainsail to incorporate a full roach design - a more aerodynamic shape both for racing and cruising performance.

To accomplish this, the B&R rig has 30 degree swept spreaders, creating 120 degrees between each rigging point. This tri-pod arrangement has excellent strength for sailboat rigs, and has been used for years to support huge radio towers.

The B&R rig is designed to be pre-bent to further add rigidity to the mast section and eliminate the need for adjustable rigging (like backstay adjusters). This design should prove more reliable than a rig with adjustable backstays or runners, as there is less chance for error.

The large main, small jib, sail plan on the 18 also eliminates the need for large overlapping headsails (genoas), as the driving power comes from the much improved shape and size of the mainsail. This offers an easier tacking small jib, creating good performance and more comfortable sailing as it is less work for the crew.

B&R rigs have been used on thousands of sailboats, and we are proud to incorporate this successful design on your new Hunter.

5.7 Protecting Your Rigging

Without careful inspection and proper maintenance, the rigging is subject to fatigue, wear, discoloration, and therefore, product failure. Remember: regular inspection and cleaning will increase the life of your investment and secure your rigging. We suggest the following:

- Always rinse your rigging with fresh water after sailing, especially salt-water sailing. Salt can create corrosion pits, causing cracks and deterioration.
- Clean with a water-soluble chlorine-free detergent. Nonabrasive cleansers are best for hard white vinyl coated cables.
- Inspect rigging for stains. Rust stains may indicate stress cracks or corrosion. Remove stains with synthetic or brass pads. Never use steel wool pads.
- Look for broken wires- a sign of fatigue in rigging. Replace standing rigging if wires are broken.
- Never mix stainless steel and galvanized metals on cable, fittings, pins, cotter keys, etc. If mixing dissimilar metals, electric currents may conduct between metal causing rapid deterioration
- Store rigging in a dry place. Never store in a plastic bag, which can cause corrosion.

with fine-grained emery paper if necessary. Also, replace any missing or damaged cotter pins in turnbuckles and shackles, and either tape them or use them or use protective covers manufactured for that purpose.

5.7.1 Sail Care

Sunlight is a sail's worst enemy, so **cover the mainsail when not in use**. An ultraviolet guard, fitted down the leech of a roller headsail will protect the exposed part from the weathering effect of the sun and from dirt and grit. Mildew, can be prevented by storing sails dry and by hand washing twice a season. Check all sails regularly for chafe, particularly where they chafe on deck fittings or rigging, at reef points, batten sleeves and the foot of the headsail. Sail batten pockets should be inspected on a regular basis.

To stow the mainsail, start at the leech and flake it onto the boom, left and right, in about 18-in. (46 cm) folds, while pulling the leech aft. Secure with a sail tie and continue to the luff. Lash to the boom with sail ties or shock cord.

5.7.2 General Hardware Maintenance

Check all fittings regularly to be sure screws are tight. Occasionally lubricate (use silicone lubricants) all moving parts on such fittings as blocks, turnbuckles and cam cleats, as well as the locking pins of snatch blocks, track slides, spinnaker poles, etc. Inspect cleat and fairleads for roughness and smooth

Standing Rigging Details

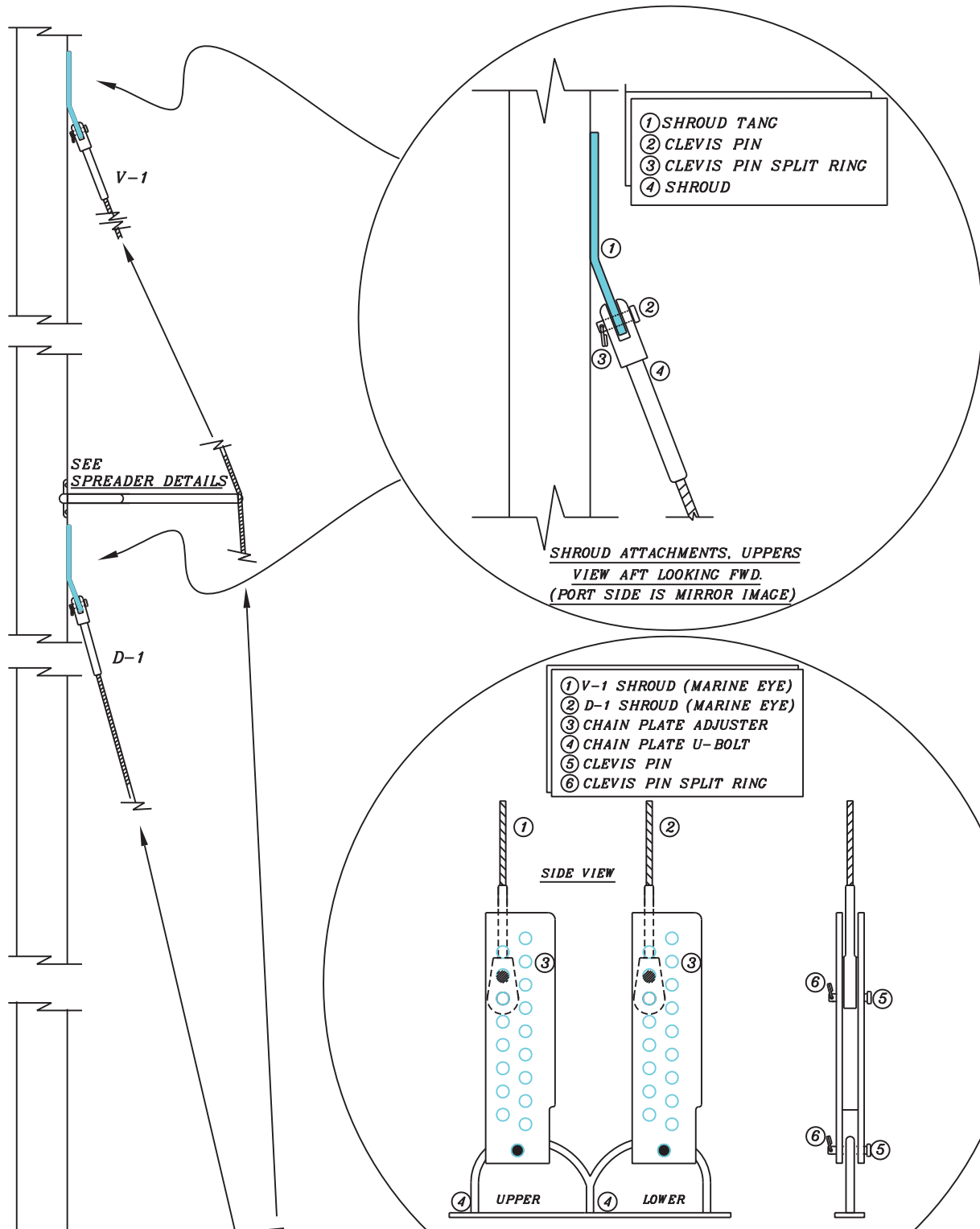

Standing Rigging Details(Furling)

UPPER FORESTAY/SHROUD/TOPPING LIFT ATTACHMENT

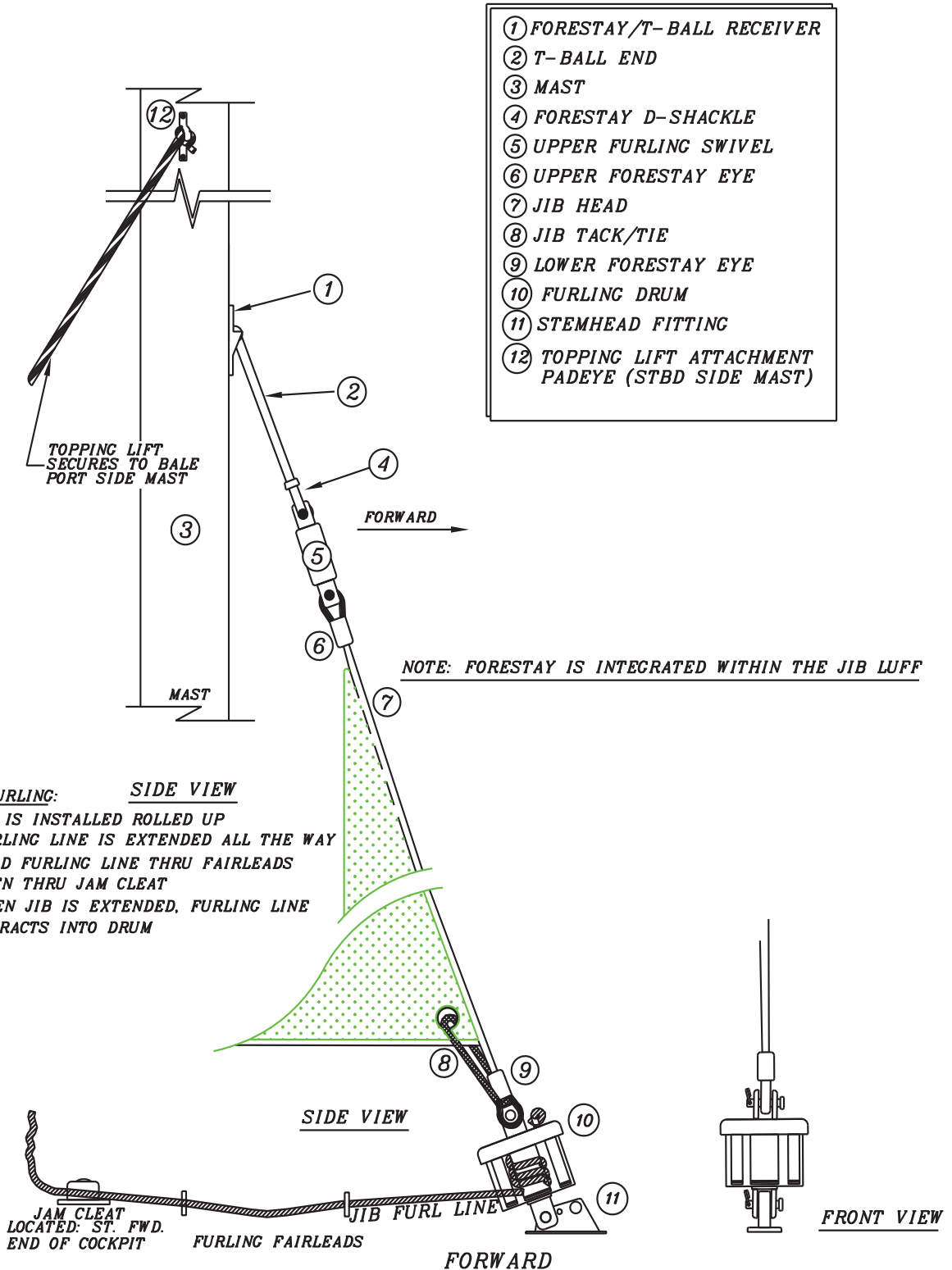

Mast Details

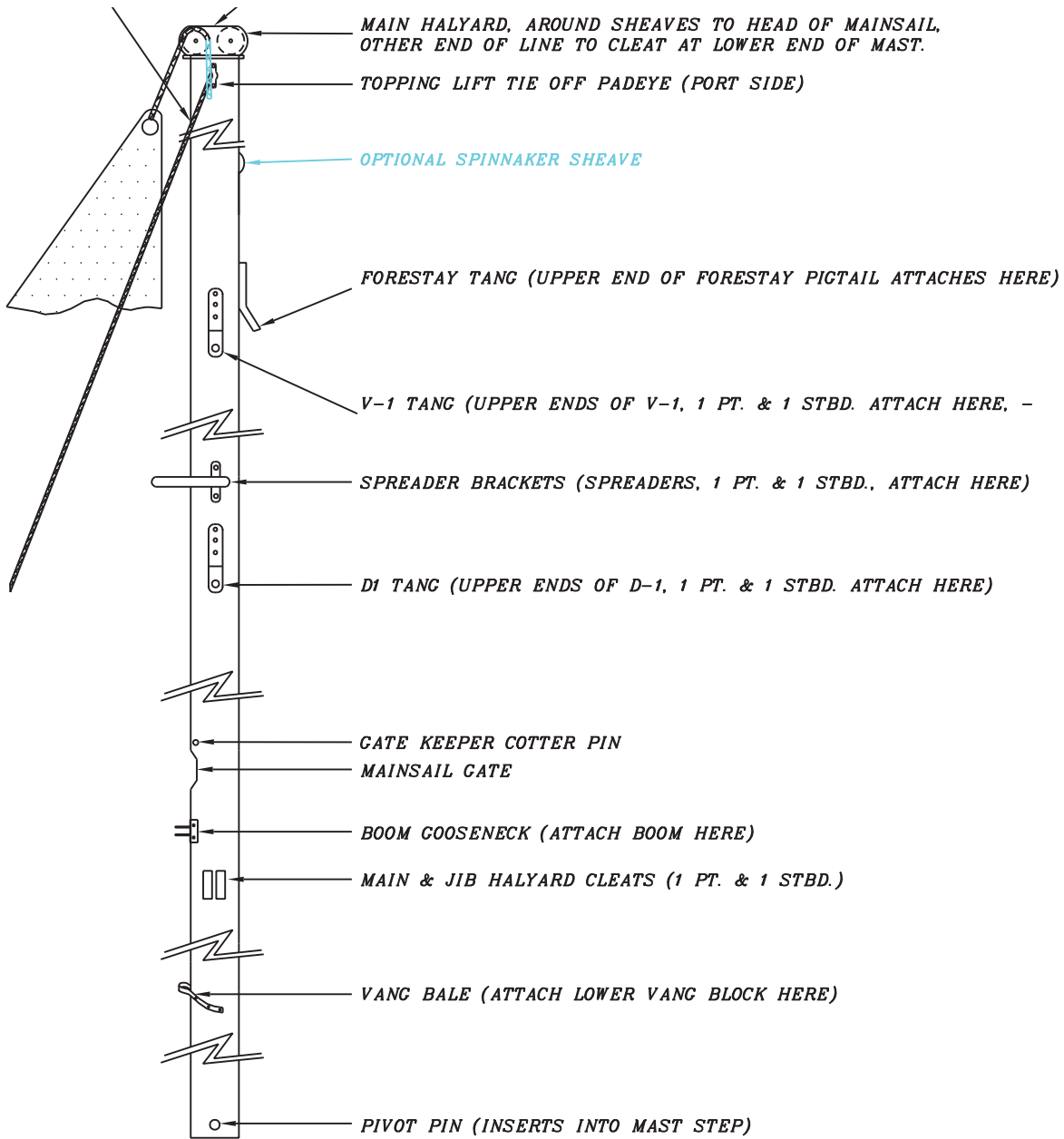

MAST BASE

FWD. →

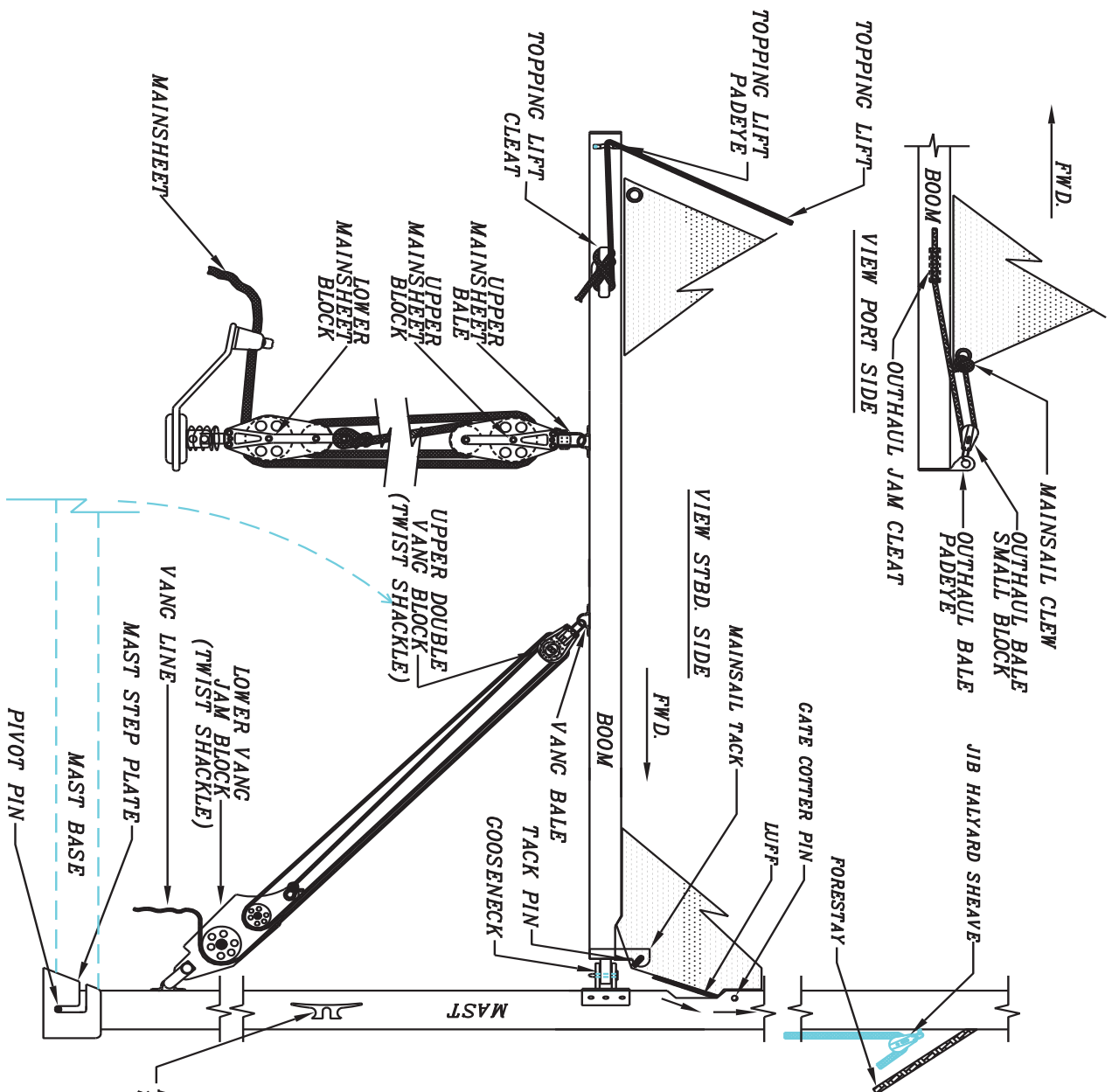

ASSEMBLY ORDER

1. AFTER ATTACHING SHROUDS & FORESTAY (SEE PAGE 34C-1) & BOOM TOPPING LIFT TO TOP OF MAST. (SEE PG. 34C-3) INSTALL MAST BASE INTO MAST STEP. (SEE PAGE 34B-9) RAISE MAST & ATTACH FORESTAY AND SHROUDS TO DECK FITTINGS, AS SHOWN ON PAGE 34C-1.
2. ATTACH BOOM TO GOOSENECK
3. ATTACH TOPPING LIFT TO BOOM.
4. ATTACH MAINSHEET PURCHASE
5. ATTACH VANG
6. SLIDE MAINSAIL CLEW INTO THE GROOVE ON THE BOOM. ATTACH THE MAINSAIL OUTHAUL LINE AND BEGIN EXTENDING THE SAIL AFT BY PULLING THE OUTHAUL LINE AS YOU GUIDE THE SAIL INTO THE GROOVE.
7. REMOVE GATE COTTER PIN
8. SLIDE MAINSAIL LUFF INTO THE LUFF GROOVE ON MAST. RAISE MAINSAIL WHILE "FEEDING" LUFF INTO THE LUFF GATE TO AVOID "BINDING" THE SAIL.
9. ATTACH MAINSAIL TACK TO GOOSENECK TACK PIN
10. RAISE MAINSAIL BY PULLING ON HALYARD AS YOU GUIDE SAIL LUFF INTO LUFF GROOVE ON MAST
11. INSTALL GATE COTTER PIN (SEE PAGE 31 FOR REEF LINE INSTALLATION)

MAIN/JIB HALYARD CLEATS
1 FOR EA. PT. & STBD.

Mast Upper Spreader Details

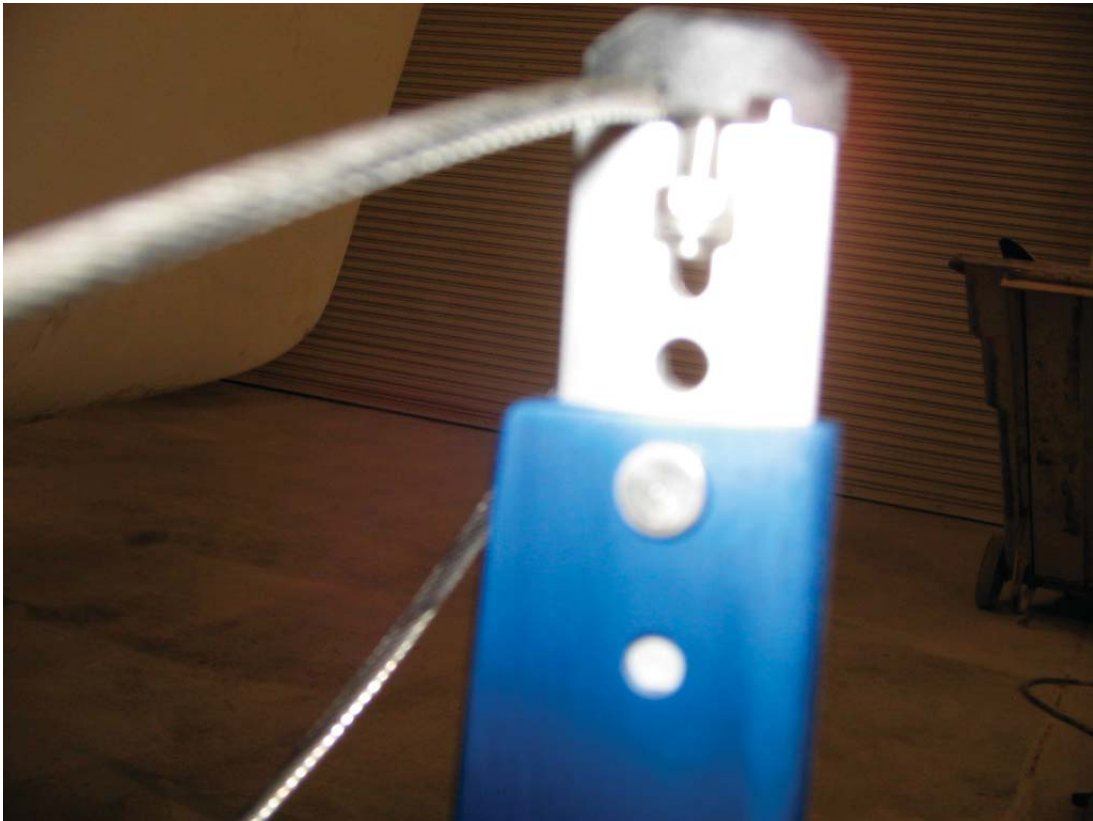

SPREADER TIPS SHOULD BE APPROX. 52" TIP TO TIP

Mainsheet Purchase Layout

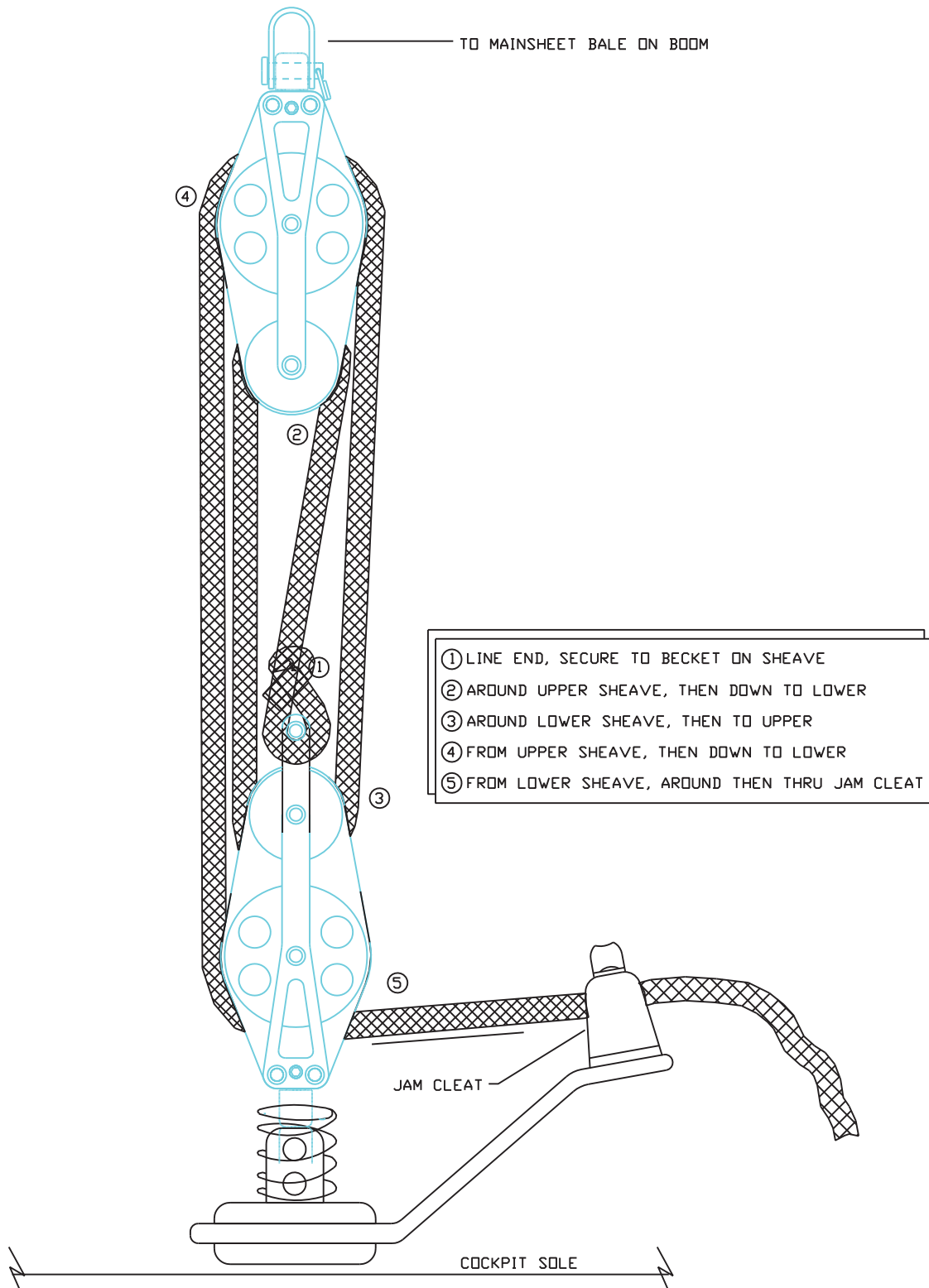

Typical Boom Reefing Layout

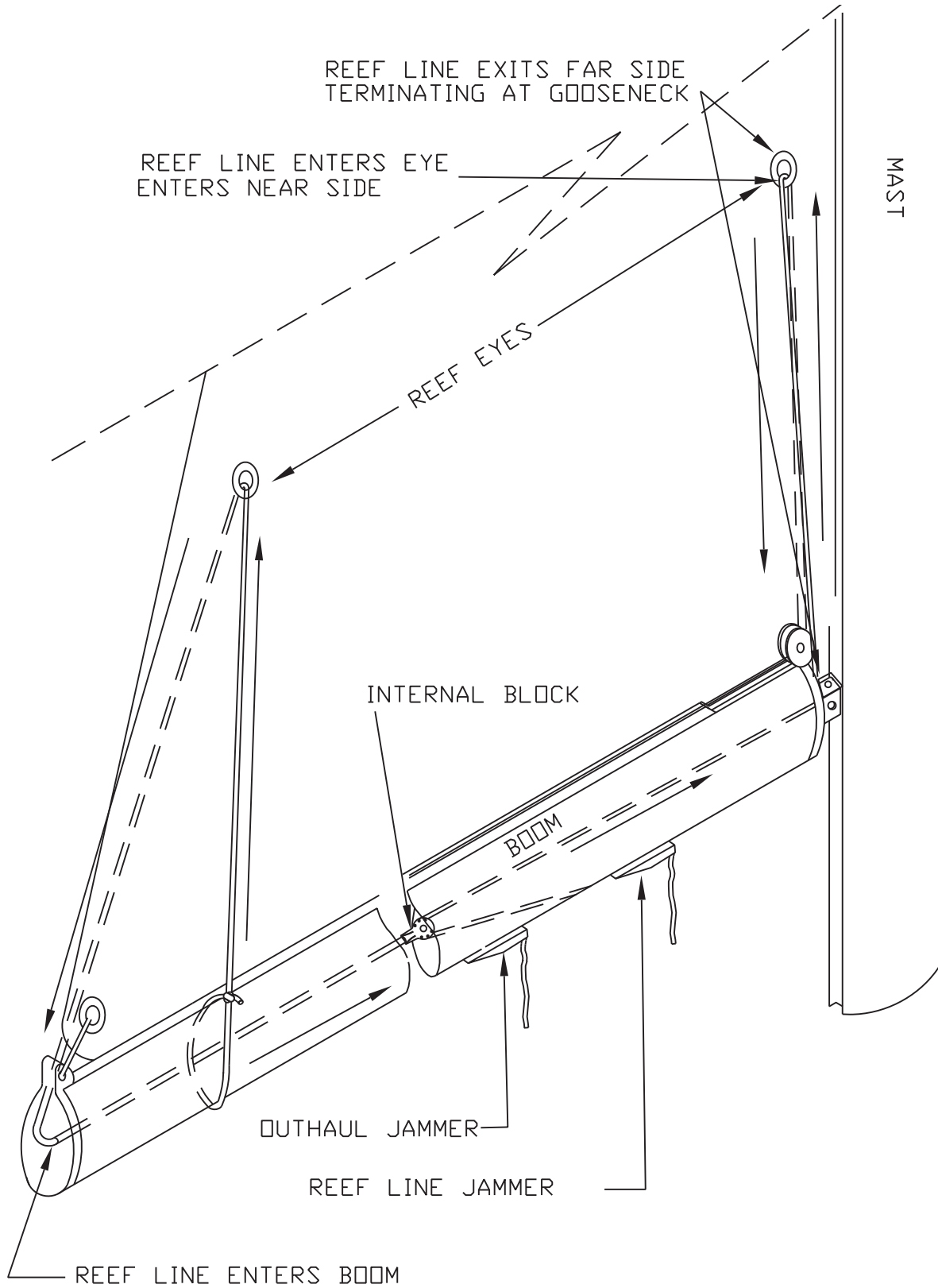

Standard Vang Details

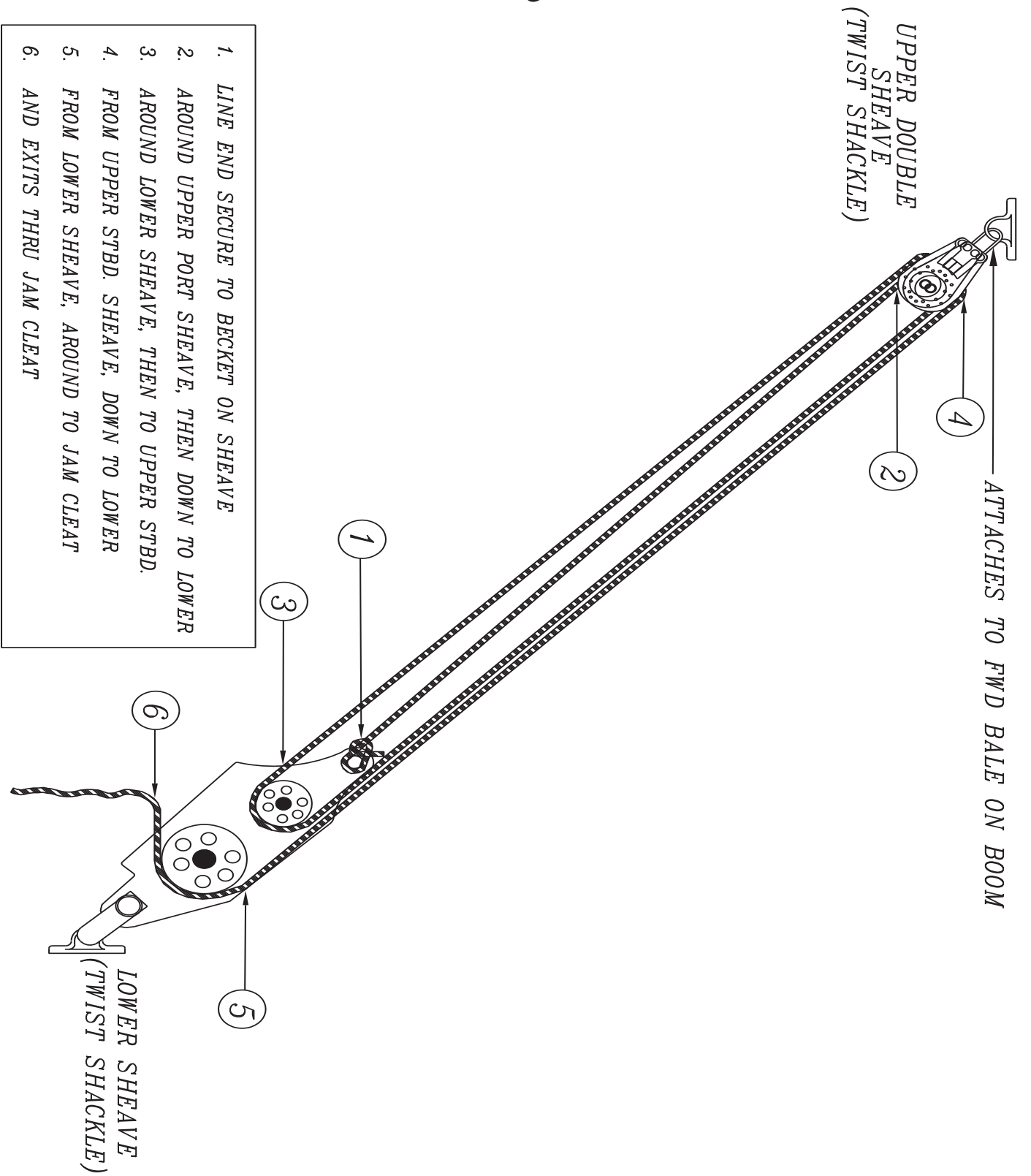

Optional Spinnaker Layout

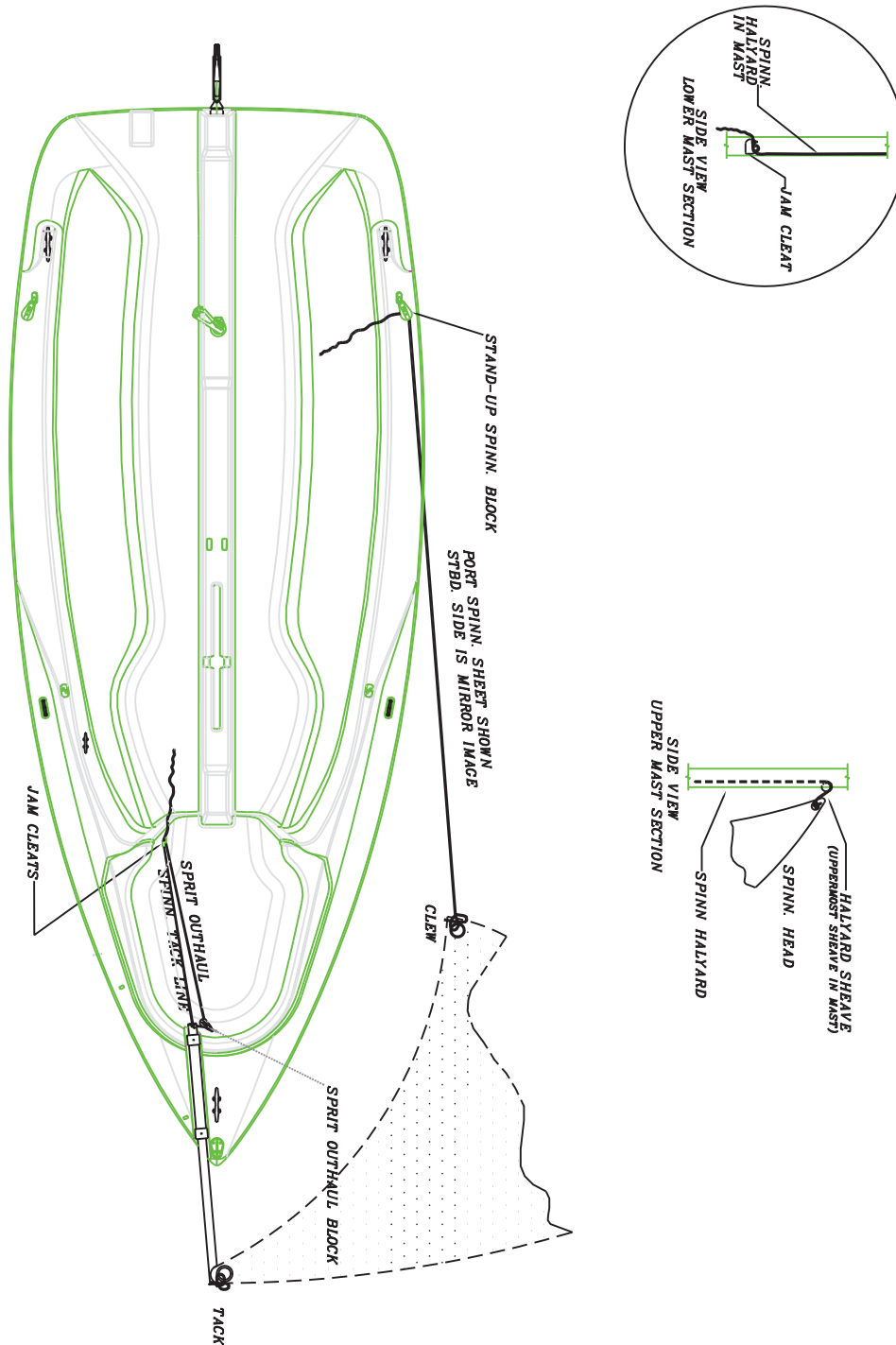



H U N T E R[®]

MARINE CORPORATION

AN EMPLOYEE OWNERSHIP COMPANY

We Go The Distance

Chapter 6

Getting Underway

H18



Before you go on the first cruise, you should be able to answer “yes” to the following questions:

- Has your dealer completed the pre-delivery service inspection? Have you and your dealer signed the Pre-Delivery Inspection Report?
- Have you filled out and mailed all warranty registration cards?
- Have you read and do you understand this owner’s manual and the OEM manuals?
- Has your boat been registered with the proper authorities? Does your hull display the proper identification?
- Has your dealer reviewed with you the operation of the boat and its systems? Has your dealer answered all your questions?

If you have taken care of these preliminary steps, you are ready to take your first cruise. Before you start, give some thought to the cruise itself. Choose a calm day if you can.

6.1 Boarding your Boat

Make it a routine to visually inspect the exterior of your boat every time you approach it to board. Look for signs of damage that could be caused by the dock or other boats.

6.1.1 Preparing to Board

As you board your boat, you should make sure you have all gear safety gear aboard and a plan for exiting the boat ramp. If your boat is equipped with an engine, please remember that CO fumes can be deadly. Since your boat may be equipped with an outboard engine that is exterior mounted and there is no enclosed cabin, there is no CO alarm installed which would indicate the presence of deadly Carbon Monoxide gas. The dangers of Carbon Monoxide are detailed at length in the Boating Safety Chapter of this manual, and in the insert that is placed in the Boating Safety Chapter.

Accumulation of CO can be deadly. Be sure to operate your engine in a well ventilated area and be mindful of the smell of exhaust fumes as these are a sign of the presence of CO gas.

6.1.2 Upon Boarding

If you detect fuel fumes, follow the procedures listed here and in the Fuel Chapter of this manual.

6.1.3 Strong Fuel Fumes

Fuel fumes are heavier than air and can collect in the bilge area. These fumes are extremely hazardous. If you detect strong fumes, proceed as follows:



Leaking fuel is a fire and explosion hazard. Personal injury or death could occur.



Explosive fuel vapors can become trapped in the lower portions of the boat. Close all hatch covers, windows, doors, and compartments while fueling your boat.

1. Evacuate all occupied enclosures immediately.
2. Shut down engine.
3. Turn off all electrical circuits.
4. Inform the dockmaster if possible. Have a qualified technician check the boat immediately to determine the source of the odor.
5. Open the boat for natural ventilation.
6. When you can no longer smell fumes, locate the source. Dispose of fuel in a safe, approved manner.

6.2 Launching

1. Remove all tie down straps securing the boat to the trailer as well as any lines securing the rudder in the upright position or on centerline. The only attachment of the boat to the trailer should be the strap from the bow eye to the trailer winch.

⚠ DANGER ⚠

Be aware of nearby power lines. Contact with power lines and the spar may result in electric shock causing severe injury or death.

2. The spar can be raised before or after launch, depending on the docking facilities after launch. **BE AWARE OF POWER LINES IN THE AREA!**

3. Attach the necessary mooring lines and fenders if necessary. Do not lower the fenders over the side until the boat is clear of the trailer.

4. Initially slacken the trailer winch and familiarize yourself with its gear switch action and return the winch to the locked position.

5. Loose gear may now be loaded if necessary. The rudder and centerboard should be in the up position

6. Back the boat and trailer down the ramp until the trailer wheels are just clear of the surface of the water. Retrieve the bow and stern lines as necessary. Loosen the trailer winch and bow strap.

7. Once the boat is floating free, push the boat clear of the trailer guides to the available dock maintaining control with the mooring lines.

8. Slowly pull the empty trailer out of the water being careful that the boat and people are clear.

6.2.1 Running the Engines

Now it is time to start the engines. This is accomplished by the following procedures:

1. First, move the throttle to the neutral position.
2. Next, turn the switch to the "On" position.
3. Start the engine by pulling the start chord.
4. Once the engine warms up to operating temp (check manufacturer's recommendations for correct warm-up procedure), move the shift lever to Fwd and Reverse to make sure that the transmission will engage.

⚠ WARNING ⚠

Exhaust gasses contain Carbon Monoxide. This is a poisonous gas and can cause death. Shut down

engines immediately.

Important: Always be careful when starting the engines. Use common sense and good judgment. Shut down the engine immediately if you observe any unsafe operating conditions.

6.3 Getting Underway

Verify that you have up to date safety equipment.

Make sure you have the required safety equipment for your passengers.

Check wind, tide, and current to determine the best way to maneuver your boat away from the dock. Lower the rudder and centerboard to the proper depth and cast off mooring lines.

Shift your boat's engine into forward or reverse, depending on whether you want to move the bow or the stern away from the dock first. Your engines should be running at a slow speed as you move away from the dock.

Once your boat is in open water, you can safely accelerate to cruising speed. Advance throttle to setting which provides your desired engine speed (RPM's).

6.3.1 Getting Ready to Sail

Note: This is not intended to provide a complete guide on sailing! The 'art' of managing a sailboat in all weather, tidal and day/night conditions can not even be taught by reading even the best instruction book. If you are not proficient in handling sail boats please refrain from handling this boat and obtain professional training and certificates of which some might be required for you to navigate this boat in certain areas or countries.

The following is a simple guide only:

⚠ WARNING ⚠

Be sure the rudder and centerboard have been lowered prior to raising any sail

1. Place the mast base into its step and raise it to its upright position. Attach the forestay and shrouds per the sails and rigging section of this manual.
2. Install the boom onto the gooseneck and secure the topping lift to the aft side of the boom.

3. Connect the main sheet purchase to the boom and install the vang as the sails and rigging section shows.

4. Run the jib furling line through the leads and finally through the jammer cleat located on the starboard side of the deck.

5. Install the battens in the mainsail (if required) and install the mainsail onto the boom from the aft end. Remove the stop pin or open the sail gate in the mast and install the luff slides into the track on the back of the spar. Reinstall the stop pin or close the sail gate to prevent the slides from falling back out again. Connect the main sail to its halyard and pack the sail on your boom.

2. Install the out haul line in the boom with the messenger line provided and lead from the sheave at the back of the boom through the lower cringle at the back of the sail and aft to the end of the casting.

3. Install reefing lines in the boom with the messenger line provided per the diagram in the sails and rigging section. Pull enough slack into the reef line so that the sail can be fully raised unimpeded by the reef lines. Tie the mainsail onto the boom with the sail ties provided.

4. Install the jib sheet onto the jib and lead the sheets inside the shrouds to the lead jammer blocks on the gunwales. Tie figure eight knots in the end of the sheets to prevent them from running back through the jams.

5. Raise and unfurl sails, beginning with the main and then the jib while powering into the wind. Once each halyard is tensioned, the halyard can be pushed down into its respective rope clutches. However, care should be taken not to inadvertently open the rope clutches, since the sails will lower rapidly if this is done. When the sails are raised, the boat can be laid off and the engine turned off.

6. Once the main is sheeted in and you are sailing upwind, confirm the main topping lift position. The main should be capable of sheeting in hard without the topping lift being tight. With the main sheeted in hard, the topping lift should have eight to ten inches of sag and should be adjusted accordingly.

7. After a day of sailing, the sails should be lowered/furled in while again powering into the wind, with the jib furled in first and then by lowering the main. Protect your sails by covering them with the sail cover or furling them completely up.

6.4 Returning to Port

After completing the day's cruise and mooring your boat, shut down the engine.

* Reduce engine speed to idle. Place transmission control in neutral. Allow engine to idle for a few minutes.

* Move switch to OFF to shut down the engine.

Before going ashore, check the following items:

- Boat securely tied to dock
- Sails are secured
- Centerboard and rudder are up if trailering.

A thorough washdown of your hull, decks, and rigging with soap and fresh water will help keep your boat looking like new for years.

6.4.1 Retrieving



Be aware of nearby power lines. Contact with powerlines and the spar may result in electric shock causing severe injury or death.

1. Raise Centerboard and rudder.
2. Back trailer into water remembering boat will be floating lower if there is more gear on board than when you started.
3. Maneuver boat between trailer guides and up to the winch with the mooring lines.
4. Connect the bow strap and with the winch in gear, winch boat up snug against bow stop.
5. Center boat between upright aft trailer guides.
6. Slowly pull the boat from the water until the weight of the boat is on the trailer.
7. Confirm alignment on the trailer. Put trailer back in the water to re-align if necessary.
8. make sure the rudder is pinned or tied in the upright position to prevent it from dragging on the ground.
9. De-rig and unstep mast if not already done. **BE AWARE OF POWERLINES WHEN LOWERING MAST!**

10. Tie boat to trailer and secure the mast and rigging.

6.5 Emergency Operations

You should always understand and be prepared to engage in Emergency Operations aboard your boat. The sea is unforgiving in this area, and you can find yourself in very bad trouble in a very short time, even if you are prepared.

Do not rely on this manual to educate you in all the emergency procedures aboard your boat.

Always insure that you, and all aboard know the outlines for emergency operations.



H U N T E R[®]

MARINE CORPORATION

AN EMPLOYEE OWNERSHIP COMPANY

We Go The Distance

Chapter 7

Maintenance

H18



Maintenance

(The information below is Hunter Marine's opinion and should not be considered complete or exact list of recommendations.)

You have made the investment to purchase your boat. Now is the time to take care of it. Here we will supply you with the knowledge to do just that.

We will separate this chapter into sections that deal with each part of your boat. The exterior, the interior, and the mechanical components. At the end of the chapter, we will offer you some maintenance tips and also give you a schedule of maintenance to be performed. Remember that any manufacturer's recommended maintenance schedules supersedes ours and their specific schedules or tasks should be performed.

7.1 Maintenance Materials

Following is a list of tools we recommend that you carry on board your yacht. Note that this list is the minimum required:

- Flashlight
- Vise grips (small and medium)
- Needle nose pliers
- Screw and nut driver set with ratchet handle
- Multi-bladed knife
- Set of screwdrivers (Phillips and flat blade, including "shorty" in both)
- Offset screwdriver
- Set of combination wrenches (box at one end, open end at the other)
- Extra batteries for flashlight
- Set of tubing wrenches
- Hacksaw

7.1.1 Recommended Maintenance Materials

We recommend that you carry the following on board your yacht:

- Plastic marine tape
- Instant glue
- Silicone rubber
- Electrical tape
- Two-part epoxy adhesive
- Spray lubricant

7.1.2 Recommended Spare Parts

We recommend that you carry the following spare parts on board your boat:

- Pull start chord for engine (if installed)
- Assorted fasteners

To keep the exterior of your boat in good condition, you should follow a periodic preventive maintenance program and practice good storage habits. In this section, are important suggestions that will help keep your boat in the best possible condition.

7.2 Exterior

7.2.1 Care and Maintenance During Summer Months

Before storing your boat, remove loose items such as cushions, towels, and similar items. Water trapped under these items can cause gelcoat discoloration and mildew.

After each use, rinse the entire boat with fresh water. If the boat has been used in brackish or salt water, use a mild soap during the washdown.

Covering your boat between uses will protect the finish from direct sunlight. Do not cover it with anything that will not allow moisture to evaporate, for example, sheet plastic.

7.2.2 Finish Protection

Waxing two or four times a year is recommended. If you are in a climate where you use your boat year round, wax your boat every three months. If you have a summer boating season, wax at the beginning of the season and before winter storage.

Waxing helps protect your boat from everyday elements. Use a wax recommended for fiberglass (gelcoat) finishes. Many automatic, over-the-counter waxes can be used. Check the product label for recommended surfaces and applications.

7.2.3 Color Fading and Yellowing

Darker colors are more prone to fading because they absorb more of the sun's ultraviolet rays. Whites and off-whites will yellow, usually on the deck radii. If the finish on your boat has started to fade or yellow, and waxing will not restore the finish, compounding with a fine grit

compound and a low speed buffer may be necessary. An automotive, fine grit rubbing compound will work well in most cases.

* Follow the manufacturer's application instructions. Do not apply compound or wax in direct sunlight.

* Never place the buffer in such a manner that the pad touches the ground. The pad will pick up dirt which will cause deep scratches in the finish.

* After compounding, clean the surface with soap and water. Apply a good coat of wax.

7.2.4 Minor Scratches

If you have light surface scratches and rubbing compound does not remove them, wet sanding may be necessary.

** To wet sand:

* Clean the area with soap and water. During sanding, try to keep the area free of dust and dirt.

* Use a 500 or 600 grit wet and dry sandpaper. Use a sanding block. Sandpaper and sanding blocks can be purchased from automotive supply stores.

* When sanding, keep the surface wet. On dry surfaces, press a wet sponge above the sanding area. Always keep the sanding block flat on the surface. Never use the edge or corner. Doing so will make scratches that rubbing compound will not remove.

* After completing wet sanding, compound the sanded area with a fine grit rubbing compound. Use a low speed (1200 – 2800 rpm) buffer. Several applications of rubbing compound will have to be applied before all the scratches are removed.

* Apply a good coat of wax.

7.2.5 Stains

You can remove stains using a cleaner specifically made for gelcoat surfaces. Any cleaner recommended for cultured marble or fiberglass tubs and sinks will work. Most of these cleaners can be purchased at a grocery store.

If a cleaner does not remove the stain, use a fine grit rubbing compound. By hand, apply a small amount of the compound to the stain area. Using a cotton cloth and medium pressure, rub the compound into the stained

area. After the stain is removed, wash the area with soap and water and apply a good coat of wax.

7.2.6 Stainless Steel

Your Boat Hardware is made from top quality stainless steel and with proper care and maintenance will give you many years of service.

Mirror Finish

The mirror finish on most of your stainless hardware is produced by a series of progressive machine and hand polishing operations. It is this careful polishing that makes the stainless finish so beautiful...and easier to clean and maintain.

Recommended Cleansers

We have reviewed several general stainless cleansers/polishers to determine their effectiveness in cleaning and protecting your stainless steel. Even though opinions will certainly differ, our opinion is that one of the most effective cleaning and polishing products is Collinite® # 850 Metal Wax. To help maintain the factory finish of your stainless steel hardware, try the recommended cleanser because you may agree with us.

Recommendations for Cleaning

- Do...Apply an even layer of the polishing compound onto a clean soft rag and distribute over a manageable area of the stainless surface with a soft rotational motion.
- Do...Repeat the application if some surface stains remain until all the finish is back to the original clean shiny finish.
- Do...Remove any excess polishing compound and polish out the stainless finish for a mirror shine.
- Do...Rinse thoroughly with fresh water after each cruise. Thorough rinsing can prevent a lot of the surface staining that stainless steel produces when left in contact with salt water residue.
- Do...Dry after each use to prevent mineral deposits from building up on the surface of the finish.
- Don't...Scour the stainless. Scouring can damage the original finish.
- Most brands of cleansers contain chemical additives which will affect the original high polish finish if left on the stainless.
- Don't...Use a steel wool pad to clean your stainless. If a more abrasive product is needed, use a stainless polishing paste being sure to rub in the paste with a clean rag. Steel wool pads have a tendency to break apart and

small particles of steel can become embedded in the surface and will rust and will give the appearance that the stainless itself is rusting.

Following these recommendations for the care and cleaning of your stainless steel will help insure that it will provide you with many years of service.

Chlorides

Today, chlorides are found in almost all soaps, detergents, bleaches and cleansers; chlorides can be aggressive to stainless steel. However, chlorides are very water soluble. Therefore, THOROUGH RINSING of your bright work after each use will help to keep your stainless looking bright and shiny.

Scratches

Like many metallic surfaces, your stainless steel will scratch. These are merely usage scratches and over time will blend into the overall finish. Surface scratches can be polished out with a polishing paste but this can be a lengthy and work intense process.

7.2.7 Deck Hatches

Wax the rubber gaskets on all deck hatches with a carnauba wax to ensure gasket material does not stick to its mating surface.

7.2.8 Acrylic and Plexiglass

Important: Do not use glass cleaning sprays, scouring compounds, or solvents (such as acetone, gasoline, or thinners) to clean acrylic or Plexiglass.

Following are guidelines for cleaning acrylic and Plexiglass parts:

- * Wash acrylic hatches, windows, and any other acrylic compounds with mild soap and plenty of lukewarm water.
- * Use a clean, soft cloth.
- * Apply only a light pressure when cleaning.
- * Rinse with clear water, and blot dry with a damp cloth or chamois.

7.2.9 Caulking

All deck fitting, bow rails, windows, hatches, etc, have been caulked with the highest quality material to ensure a waterproof joint with the boat. However, normal use will flex the joint and eventually break down the seal.

Note: We recommend that all deck fittings, hatches, etc. be caulked periodically to prevent damaging leaks from developing.

7.3 Mechanical Systems and Components

Refer to the manuals supplied by the boat component manufacturers for their recommended periodic maintenance. The manuals may indicate maintenance requirement, in addition to, the minimum maintenance tasks listed in the following charts.

Note: In case of conflicts between the maintenance information in this manual and the manuals supplied by the equipment manufacturer, the equipment manuals take precedence.

7.3.1 Engine Gear Oil

See engine operating manual for recommended oils and correct procedures for checking and replenishing oil.

7.3.2 Fuel Line Connections

Check all fuel line connections for leaks at least once a year. Tighten as necessary.

Important: Be careful when tightening fittings. Over-tightening can crack the flair fittings and flair nuts. Use only tube wrenches when tightening connections.

7.4 Periodic Maintenance

Proper and timely maintenance is the best insurance you can buy for trouble free and pleasurable boating. Included in this section are maintenance charts which identify maintenance tasks and their frequency. Use the charts as a checklist.

Following are specific maintenance tasks that you should complete after the first 20 hours of operation:

- * Tighten all engine mounts.
- * Complete engine maintenance as recommended by engine manufacturer.
- * Tighten all hose clamps and lubricate them.

At the end of this chapter, you will find a maintenance schedule. It is important that you keep the manufacturer's documentation for the components and follow the maintenance schedules and procedures listed in that literature. This information takes precedence over what is supplied by the boat manufacturer.

7.5 Storage and Lifting

In most cases, the reason for storage is winter layup. The information in this section is a general guide. Your boat dealer or a competent boatyard should prepare your boat for winter storage. If you are removing your boat from the water for another reason, use the information in this section as a guideline. Following the procedures in this section helps to extend the life of your boat and its equipment and simplifies re-commencing in the spring.

Indoor storage is beneficial if you are storing your boat in a climate that produces ice and snow. However, the storage building should be adequately ventilated, not tightly closed. Ventilation around the boat, is very important.

If you use outdoor storage facilities, cover your boat with a canvas cover with provisions for ventilation to keep the boat from "sweating." Building a frame over the boat to support the canvas will allow the passage of air around the boat. The frame should be a few inches wider than the boat so the canvas will clear the rails.

Before preparing your boat for winter storage, check the condition of the boat and its systems and equipment. Note any repairs needed. The need for other repairs may become apparent during winterization. Make arrangements to have the repairs completed.

7.5.1 Lifting Your Boat

Following are guidelines which will help prevent damage to your boat as it is being lifted.

- * Never hoist the boat with a greater than normal accumulation of water in the bilge.
- * Use flat, wide slings made of belting and spreader bars

long enough to keep pressure off the gunwale. Do not use cable slings. Pressure by the slings on the gunwale can cause severe gelcoat crazing or more serious hull damage.

- * The spreader bar at each sling should be as long as the distance across the widest point the sling surrounds.

- * Your boat is designed to be stored on a trailer with longitudinal support on at least 2 rails. This will help distribute the weight and prevent stress cracking from point loading.

7.5.2 Draining Your Boat

Your boat has a drain plug on the transom for draining water from the bilges. The tongue of the trailer can be propped up so that the drain plug will be the lowest point and thereby drain the bilge when opened.

7.5.3 Preparing for Storage

- * Clean, scrub, and sponge the hull and deck as soon as the boat is pulled from the water and is still in the trailer. Cleaning marine growth from the hull is easier when it is still wet.

- * Clean the inside of all hull openings, through hull fittings, and screens. Inspect the hull and underwater gear for signs of wear, deterioration, or damage. Note any damage to the propulsion equipment, rudder and centerboard, etc. Make repairs, if at all possible, before covering your boat.

- * Fill the fuel tank with treated fuel to prevent condensation. If you use a stabilizer or conditioner, be sure to follow the instructions on the container.

Important: Do not overfill fuel tanks so fuel flows from the vent. Allow room in the tanks for fuel to expand.

**** Prepare the Engine for Storage:**

- * In areas where temperatures fall below freezing, the bilge area must be completely dry.

Note: Refer to the engine owner's manual for winterization and storage procedures.

- * Make sure all garbage is removed.

- * Scrub the inside of the boat.

* Stand or prop up cushions remaining on board to allow good air circulation around them. Hang life preserver and other equipment to prevent mildew.

* Remove any detachable and valuable equipment and electronics.

** Prepare Exterior of Boat for Storage:

* Apply a coat of wax to the entire boat. Put rust inhibitor on all metal parts.

* Cover the boat with a tarpaulin or mooring cover. If the boat is stored outside, you may need to place supports under the cover to shore up pockets where rain or snow can collect.

7.5.4 Draining Your Boat

Your boat has a drain plug for draining water from the bilges. Prop the trailer tongue and remove the drain plug so that any water that may enter will drain

7.5.6 Supporting Your Boat During Storage

A trailer is the ideal support for your boat whenever it is not in the water. Properly designed and located, the trailer will support the boat under the main frames. Support at these points is essential for preventing damage to the hull.

If a trailer is not available, the boat may be supported on two longitudinal timbers along the bottom of the boat. The timbers and the foundation must be substantial enough to prevent any change in shape while supporting the boat during storage. The weight carried by the supports should be evenly divided.

Store the boat with the bow up so any accumulation of moisture will run off.

7.6 Fitting out after Storage

Before launching your boat, do not load unneeded equipment and personal items until the launch and final checkout are complete.

7.6.1 Pre-Launch Checkout

** Before placing your boat in the water, check and perform the following:

* Check all lines and gear and replace, if necessary.

* Make sure all drain plugs are installed. Check all centerboard and rudder hardware for damage and tightness. Repair or adjust as needed.

* Launch your boat.

7.6.2 Post Launch Checkout

** After launching your boat, check the following:

* Check all sources of possible leaks from bow to stern. Make this check with boat fully in the water, but still in on the trailer!

Hunter 18 • Maintenance

Routine Maintenance					
Item	Daily (after use)	75hr	250hr	Yearly	
Check and tighten all deck fittings	X			X	
Wash	X			X	
Wax				X	
Change engine gear oil				X	
Inspect rigging	X			X	



H U N T E R[®]

MARINE CORPORATION

AN EMPLOYEE OWNERSHIP COMPANY

We Go The Distance

Chapter 8

Glossary

H18



A

Aback: describes a sail when the wind strikes it on the lee side.
Abaft: towards the boat's stern.
Abeam:
at right angles to the center-line of the boat.
Aft: at or near the stern.
Amidships: the center of the boat, athwartships and fore and aft.
Anti-fouling: a poisonous paint compound used to protect the underwater part of a hull from marine growths.
Apparent wind: The direction and speed of the wind felt by the crew. It is a combination of true wind and that created by the movement of the boat.
Astern: behind the boat; to go astern is to drive the boat in reverse.
Athwartships: at right angles to the fore and aft line of the boat.

B

Back: when a wind backs, it shifts anticlockwise.
Back a sail: to sheet it to windward so that the wind fills on the side that is normally to leeward.
Backstay: a stay that supports the mast from aft and prevents its forward movement.
Ballast: extra weight, usually lead or iron, placed low in the boat or externally on the keel to provide stability.
Ballast keel: a mass of ballast bolted to the keel to increase stability and prevent a keel boat from capsizing.
Batten: a light, flexible strip fed into a batten pocket at the leech of the sail to support the roach.
Beam: 1, the maximum breadth of a boat; 2, a transverse member that supports the deck; 3, on the beam means that an object is at right angles to the centerline.
Bear away: to steer the boat away from the wind.
the direction of an object from an observer, measured in degrees true or magnetic.
Beat: to sail a zigzag course towards the wind, close-hauled on alternate tacks.
Belay: to make fast a rope around a cleat, usually with a figure-of-eight knot.
Bend: 1, to secure a sail to a spar before hoisting; 2, to moor a boat; 3, a sleeping place on board.
Bight: a bend or loop in a rope.
Bilge: the lower, round part inside the hull where the water collects.
Block: a pulley in a wooden or plastic case, consisting of a sheave around which a rope runs. It is used to change the direction of pull.
Boot-topping: a narrow colored stripe painted between the bottom paint and the topside enamel.
Bottlescrew: see Rigging screw.

Broach: when a boat running downwind slews broadside to the wind and heels dangerously. It is caused by heavy following seas or helmsman's error.
Broad reach: the point of sailing between a beam reach and a run, when the wind blows over a quarter.
Bulkhead: a partition wall in a boat normally fitted athwartships

C

Caulk: to make the seams between wooden planks watertight by filling with cotton, oakum or a compound.
Cavitation: the formation of a vacuum around a propeller, causing a loss in efficiency.
Center-board: a board lowered through a slot in the keel to reduce leeway.
Center-line: center of the boat in a fore and aft line.
Center of effort (COE): the point at which all the forces acting on the sails are concentrated.
Center of lateral resistance (CLR): the underwater center of pressure about which a boat pivots when changing course.
Chain pawl: a short lug which drops into a toothed rack to prevent the anchor chain running back.
Chain plate: a metal plate bolted to the boat to which the shrouds or backstays are attached.
Chart datum: reference level on a chart below which the tide is unlikely to fall. Soundings are given below chart datum. The datum level varies according to country and area.
Chine: the line where the bottom of the hull meets the side at an angle.
Cleat: a wooden, metal or plastic fitting around which rope is secured.
Clevis pin: a locking pin through which a split ring is passed to prevent accidental withdraw.
Clew: the after, lower center of a sail where the foot and leech meet.
Close-hauled: the point of sailing closest to the wind; see also beat.
Close reach: the point of sailing between close-hauled and a beam reach, when the wind blows forward of the beam.
Close-winded: describes a boat able to sail very close to the wind.
Coaming: the raised structure surrounding a hatch, cockpit, etc., which prevents water entering.
Cotter pin: soft, metal pin folded back on itself to form an eye.
Course: the direction in which a vessel is steered, usually given in degrees; true, magnetic or compass.
Cringle: 1, a rope loop, found at either end of a line of reef points; 2, an eye in a sail.

D

Dead run: running with the wind blowing exactly aft, in line with the center-line.

Deviation: the difference between the direction indicated by the compass needle and the magnetic meridian; caused by object aboard.

Displacement: 1, the weight of water displaced by a boat is equal to the weight of the boat; 2, a displacement hull is one that displaces its own weight in water and is only supported by buoyancy, as opposed to a planning hull which can exceed its hull, or displacement, speed.

Downhaul: a rope fitted to pull down a sail or spar.

Draft: the vertical distance from the waterline to the lowest point of the keel.

Drag: 1, an anchor drags when it fails to hold; 2, the force of wind on the sails, or water on the hull, which impedes the boat's progress.

Drift: 1, to float with the current or wind; 2, US the speed of a current (rate UK); 3, UK: the distance a boat is carried by a current in a given time.

Drogue: a sea anchor put over the stern of a boat or life raft to retard drift.

Drop keel: a retractable keel which can be drawn into the hull, when entering shallow waters and recovering on to a trailer.

E

Eye of the wind: direction from which the true wind blows.

F

Fair: well-faired line or surface is smoother with no bumps, hollows or abrupt changes in directions.

Fairlead: a fitting through which a line is run to alter the lead of the line.

Fathom: the measurement used for depths of water and lengths of rope. 1 fathom = 6 ft. or 1.83m.

Fid: a tapered tool used for splicing heavy rope and for sail-making, often hollow.

Fiddle: a raised border for a cabin table, chart table etc., to prevent objects falling off when the boat heels.

Fix: the position of the vessel as plotted from two or more position lines.

Forestay: the foremost stay, running from the masthead to the stemhead, to which the headsail is hanked.

Freeboard: vertical distance between the waterline and the top of the deck.

G

Genoa: a large headsail, in various sizes, which overlaps the mainsail and is hoisted in light to fresh winds on all points of sailing.

Gimbals: two concentric rings, pivoted at right angles, which keeps objects horizontal despite the boat's motion, e. g. compass and cooker.

Go about: to turn the boat through the eye of the wind to change tack.

Gooseneck: the fitting attaching the boom to the mast, allowing it to move in all directions.

Goosewing: to boom-out the headsail to windward on a run by using a whisker pole to hold the sail on the opposite side to the mainsail.

Ground tackle: general term used for anchoring gear.

Guard rail: a metal rail fitted around the boat to prevent the crew falling overboard.

Gudgeon: a rudder fitting. It is the eye into which the pintle fits.

Guy: a steadying rope for a spar; a spinnaker guy controls the fore and aft position of the spinnaker pole; the foreguy holds the spinnaker pole forward and down.

Gybe: to change from one tack to another by turning the stern through the wind.

H

Halyard: rope used to hoist and lower sails.

Hank: fitting used to attach the luff of a sail to a stay.

Hatch: an opening in the deck giving access to the interior.

Hawes pipe: see Navel pipe.

Head-topwind: when the bows are pointing right into the wind.

Headfoil: a streamlined surround to a forestay, with a groove into which a headsail luff slides.

Heads: the toilet.

Headway: the forward movement of a boat through the water.

Heave-to: to back the jib and lash the tiller to leeward; used in heavy weather to encourage the boat to lie quietly and to reduce headway.

Heaving line: a light line suitable for throwing ashore.

Heel: to lean over to one side.

I

Isobars: lines on a weather map joining places of equal atmospheric pressure.

J

Jackstay: a line running fore and aft, on both sides of the boat, to which safety harnesses are clipped.

Jury: a temporary device to replace lost or damaged gear.

K

Keel: the main backbone of the boat to which a ballast keel is bolted or through which the centerboard passes.

Kicking strap: a line used to pull the boom down, to keep it horizontal, particularly on a reach or run.

L

Lanyard: a short line attached to one object, such as a knife, with which it is secured to another.

Leech: 1, the after edge of a triangle sail; 2, both side edges of a square sail.

Leehelm: the tendency of a boat to bear away from the wind.

Lee shore: a shore on to which the wind blows.

Leeward: away from the wind; the direction to which the wind blows.

Leeway: the sideways movement of a boat off its course as a result of the wind blowing on one side of the sails.

Lifeline: a wire or rope rigged around the deck to prevent the crew falling overboard.

Limber holes: gaps left at the lower end of frames above the keel to allow water to drain to the lowest point of the bilges.

List: a boat's more or less permanent lean to one side, owing to the improper distribution of weight, e.g., ballast or water.

Log: 1, an instrument for measuring a boat's speed and distance traveled through the water; 2, to record in a book the details of a voyage, usually distances covered and weather.

Luff: the forward edge of a sail. To luff up is to turn a boat's head right into the wind.

Luff groove: a groove in a wooden or metal spar into which the luff of a headsail is fed.

Lurch: the sudden roll of a boat.

M

Marlin spike: a pointed steel or wooden spike used to open up the strands of rope or wire then splicing.

Mast Step: the socket in which the base of the mast is located.

Measured mile: a distance of one nautical mile measured between buoys or transits/ranges ashore, and marked on the chart.

Member: a part of the skeleton of the hull, such as a stringer laminated into fiberglass hull to strengthen it.

Meridian: an imaginary line encircling the Earth that passes through the poles and cuts at right angles through the Equator. All lines of longitude are meridians.

Mizzen: 1, the shorter, after-mast on a ketch or yawl; 2, the fore and aft sail set on this mast.

N

Navel pipe: a metal pipe in the foredeck through which the anchor chain passes to the locker below.

Noon Sight: a vessel's latitude can be found, using a sextant, when a heavenly body on the observer's meridian is at its greatest altitude. The sight of the sun at noon is the one most frequently taken.

O

Off the wind: with the sheets slacked off, not close-hauled.

On the wind: close-hauled.

Out haul: a rope used to pull out the foot of a sail.

Overall length (OAL): the boat's extreme length, measured from the foremost part of the bow to the aftermost part of the stern, excluding bowsprit, self-steering gear etc.

P

Painter: the bow line by which a dinghy, or tender, is towed or made fast.

Pintle: a rudder fitting with a long pin that fits into the gudgeon to form a hinged pivot for the rudder.

Pitch: 1, the up and down motion of the bows of a boat plunging over the waves; 2, the angle of the propeller blades.

Point of sailing: the different angles from which a boat may sail; the boat's course relative to the direction of the wind.

Port: the left-hand side of the boat, looking forward (opp. of starboard).

Port tack: a boat is on a port tack when the wind strikes the port side first and the mainsail is out to starboard. A boat on the port tack gives way to a boat on a starboard tack.

Position line/ Line of position: a line drawn on a chart, as a result of taking a bearing, along which the boat's position must be, i.e. two position lines give a fix.

Pulpit: a metal guard rail fitted at the bows of a boat to provide safety for the crew.

Pushpit: a metal guard rail fitted at the stern.

Q

Quarter: the portion of the boat midway between the stern and the beam; on the quarter means about 45 degrees abaft the beam.

R

Rake: the fore and aft deviation from the perpendicular of a mast or other feature of a boat.

Range: 1, see transit; 2, of tides, the difference between the high and low water levels of a tide; 3, the distance at which a light can be seen.

Rating: a method of measuring certain dimensions of a yacht to enable it to take part in handicap races.

Reach: to sail with the wind approximately on the beam; all sailing points between running and close-hauled.

Reef: to reduce the sail area by folding or rolling surplus material on the boom or forestay.

Reefing pennant: strong line with which the luff or leech cringle is pulled down to the boom when reefing.

Rhumb line: a line cutting all meridians at the same angle; the course followed by a boat sailing in a fixed direction.

Riding light to anchor light: an all-around white light, usually hoisted on the forestay, to show that a boat

under 50 ft. (15m.) is at anchor. It must be visible for 2 mls. (3 km.).

Rigging screw: a deck fitting with which the tensions of standing rigging, e.g. stays, shrouds, etc. are adjusted.

Roach: the curved part of the leech of a sail that extends beyond the direct line from head to clew.

Run: to run with the wind aft and with the sheets eased well out.

Running rigging: all the moving lines, such as sheets and halyards, used in the setting and trimming of sails.

S

Scope: the length of rope or cable paid out when making anchoring.

Scuppers: 1, holes in the toe rail that allow water to drain off the deck; 2, drain cockpit through hull.

Seacock: a valve that shuts off an underwater inlet or outlet passing through the hull.

Seize: to bind two ropes together, or a rope to a spar, with a light line.

Serve: to cover and protect a splice or part of a rope with twine bound tightly against the lay.

Serving mallet: tool with a grooved head, used when serving a rope to keep the twine at a constant and high tension.

Set: 1, to hoist a sail; 2, the way in which the sails fit; 3, the direction of tidal current or steam.

Shackle: a metal link with a removable bolt across the end; of various shapes: D, U.

Sheave: a grooved wheel in a block or spar for a rope to run on.

Sheet: the rope attached to the clew of a sail or to the boom, enabling it to be controlled or trimmed.

Shrouds: ropes or wires, usually in pairs, led from the mast to the chain plates at deck level to prevent the mast falling sideways; part of the standing rigging.

Sloop: a single-masted sailing boat with a mainsail and one head sail.

Spar: a general term for any wooden or metal pole, e.g., mast or boom, used to carry or give shape to sails.

Spindrift: spray blown along the surface of the sea.

Spinnaker: a large, light, balloon shaped sail set when reaching or running.

Splice: to join ropes or wire by unlaying the strands and interweaving them.

Split pin: see cotter pin.

Spreaders: horizontal struts attached to the mast, which extend to the shrouds and help to support the mast.

Stall: a sail stalls when the airflow over it breaks up, causing the boat to lose way.

Stanchion: upright metal post bolted to the deck to support guardrails or lifelines.

Standing part: the part of a line not used when making

a knot; the part of a rope that is made fast, or around which the knot is tied.

Standing rigging: the shrouds and stays that are permanently set up and support the mast.

Starboard: right-hand side of a boat looking forward (opp. of port).

Starboard tack: a boat is on starboard tack when the wind strikes the starboard side first and the boom is out to the port.

Stay: wire or rope which supports the mast in a fore and aft direction; part of the standing rigging.

Steerage way: a boat has steerage way when it has sufficient speed to allow it to be steered, or to answer the helm.

Stem: the timber at the bow, from the keel upward, to which the planking is attached.

Sternway: the backward, stern-first movement of a boat.

Stringer: a fore and aft member, fitted to strengthen the frames.

T

Tack: 1, the lower forward corner of a sail; 2, to turn the boat through the wind so that it blows on the opposite sides of the sails.

Tacking: working to windward by sailing close-hauled on alternate courses so that the wind is first on one side of the boat, then on the other.

Tack pennant: a length of wire with an eye in each end, used to raise the tack of a headsail some distance off the deck.

Tackle: a purchase system comprising of rope and blocks that is used to gain mechanical advantage.

Tang: a strong metal fitting by which standing rigging is attached to the mast or other spar.

Tender of dinghy: a small boat used to ferry stores and people to a yacht.

Terminal fitting: fitting at the end of a wire rope by which a shroud or stay can be attached to the mast, a tang or a rigging screw/ turnbuckle.

Tide: the vertical rise and fall of the oceans caused by the gravitational attraction of the moon.

Toe rail: a low strip of metal or molding running around the edge of the deck.

Topping lift: a line from the masthead to a spar, normally the boom, which is used to raise it.

Topsides: the part of a boat's hull that is above the waterline.

Track: 1, the course a boat has made good; 2, a fitting on the mast or boom into which the slides on a sail fit; 3, a fitting along which a traveller runs, used to alter the angle of the sheets.

Transit: two fixed objects are in transit when seen in

line; two transit give position fix.

Traveller: 1, a ring or hoop that can be hauled along a spar; 2, a fitting that slides in a track and is used to alter the angle of the sheets.

Trim: 1, to adjust the angle of the sails, by means of sheets, so that they work most efficiently; 2, to adjust the boat's load, and thus the fore and aft angle at which it floats.

True wind: the direction and speed of the wind felt when stationary, at anchor or on land.

Turnbuckle: see Rigging screw.

U

Under way: a boat is under way when it is not made fast to shore, at anchor or aground.

Uphaul: a line used to raise something vertically, e.g., the spinnaker pole.

V

Veer: 1, the wind veers when it shifts in clockwise direction; 2, to pay out anchor cable or rope in a gradual, controlled way.

W

Wake: the disturbed water left astern of a boat.

Waterline: the line along the hull at which a boat floats.

Waterline length (WL): the length of a boat from stem to stern at the waterline. It governs the maximum speed of displacement hull and effects a boats rating.

Weather helm: (opp. of lee helm).

Weather side: the side of a boat on which the wind is blowing.

Wetted surface: the area of the hull under water.

Whisker pole: a light pole used to hold out the clew of a headsail when running.

Winch: a mechanical device, consisting usually of a metal drum turned by a handle, around which a line is wound to give the crew more purchasing power when hauling taut a line, e.g. a jib sheet.

Windage: those parts of a boat that increase drag, e.g., rigging, spars, crew, etc.

Windlass: a winch with a horizontal shaft and a vertical handle, used to haul up the anchor chain.

Windward: the direction from which the wind blows; towards the wind (opp. of leeward).

Y

Yawl: a two masted boat with a mizzen stepped aft of the rudder stock/ post.