

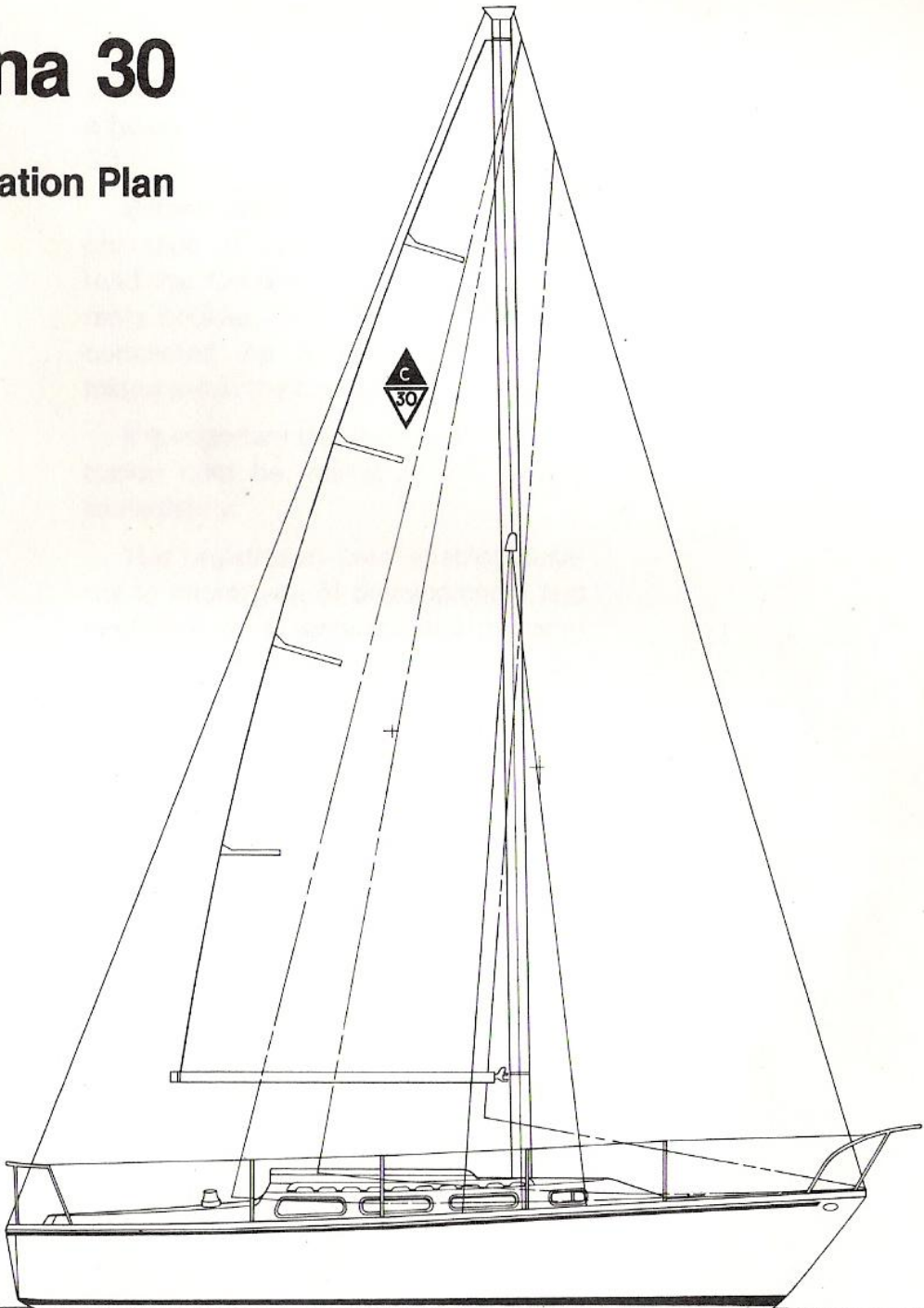

# **Catalina 30 Owner's Manual**

# Catalina 30

## Profile and Accommodation Plan



Designed by Frank Butler

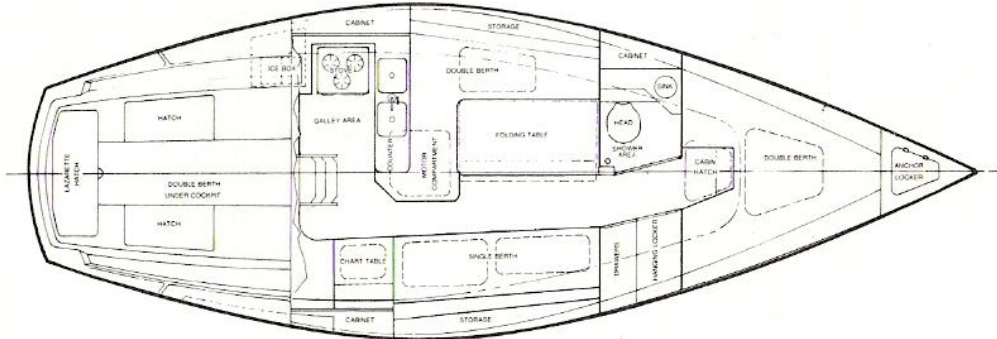

## FOREWORD

This manual is intended to serve as a guide to the features of the Catalina 30.

Before attempting maintenance or operation of your Catalina 30, please read the Catalina Yachts Limited Warranty booklet. Be sure your dealer has completed the registration card contained within the booklet.

It is important that the warranty registration card be mailed to the factory immediately.

The registration card enables Catalina to inform you of developments and modifications to enhance the performance or comfort of your yacht. It is also important to be able to contact owners to comply with Coast Guard defect notification requirements.

This manual should be used in conjunction with the GENERAL HANDBOOK which discusses care and maintenance and also includes practical sailing and safety tips.

The launching and rigging of the Catalina 30 should be handled by experienced boat yard personnel under the direction of your authorized dealer. After the boat is launched, the dealer will complete the last stages of rigging and mast tuning as described in this manual.

The last pages of this text contain a "Pre-Use Check List" and a "Before You Leave the Boat" check list. It will be useful to incorporate these checks into your sailing routine. A regular inspection is the best preventive maintenance. It will help keep your boat in good condition while in use and insure peace of mind when the boat is left unattended.



# CONTENTS

	Page	
<b>SPARS AND RIGGING</b>		
Tuning Your Mast . . . . .	6	
Fine Tuning While Sailing . . . . .	6	
Spar Maintenance . . . . .	7	
Spreaders . . . . .	7	
Rigging Maintenance . . . . .	7	
Catalina 30 Std. Rigging Specification Schedule . . . . .	8	
Catalina 30 Tall Rig Rigging Specification Schedule . . . . .	8	
<b>SAILS</b>		
Care of Sails, Refer to Handbook		
Catalina 30 Standard and Tall Rig Sail		
Areas and Rig Dimensions . . . . .	9	
<b>ELECTRICAL SYSTEM</b>		
Batteries . . . . .	10	
Main Battery Switch . . . . .	10	
110 Volt Shore Power System . . . . .	10	
Main Battery Switch Wiring Schematic . . . . .	11	
12 Volt System Wiring Diagram . . . . .	12	
12 Volt Wiring Schematic, Lamp and Circuit Schedule . . . . .	13	
<b>AUXILIARY POWER SYSTEM</b>		
General Engine Use Instructions . . . . .	14	
Engine Compartment Blower . . . . .	14	
Folding Propeller . . . . .	14	
Propeller Shaft Stuffing Box . . . . .	14	
Winterizing the Engine, General Notes . . . . .	14	
Fuel Tank . . . . .	15	
Cooling Water Intake . . . . .	15	
Engine, General . . . . .	15	
Engine Controls . . . . .	15	
<b>PLUMBING</b>		
Seacocks . . . . .	16	
Marine Head, Overboard Discharge . . . . .	16	
Holding Tank . . . . .	16	
Shower System . . . . .	16	
Galley and Head Fresh Water System . . . . .	16	
Manual Bilge Pump . . . . .	16	
<b>GENERAL OPERATION AND MAINTENANCE TIPS</b>		
Fire Extinguishers . . . . .	17	
Galley Stove . . . . .	17	
Anchors and Anchoring . . . . .	17	
Anti-Fouling Bottom Paint . . . . .	18	
Parts and Accessory Orders . . . . .	18	
<b>CLOSING WORDS</b> . . . . .		18
<b>CHECK LISTS</b>		
Pre-Use Check List . . . . .	19	
Before You Leave the Boat Check List . . . . .	19	

## TUNING YOUR MAST

Your mast is held aloft by the Standing Rigging (forestay, backstay, upper shrouds, double lower shrouds). The term "tuning" refers to adjustment of the standing rigging so that the mast remains "in column" (not bent) when under load. This is accomplished by following the procedure outlined below:

At the dock:

1. Adjust forestay and backstay so that the mast is straight up and down (perpendicular). Tie a bolt to a 6 to 7 foot long piece of light line to make a quick plumb bob, and tape the free end of the line to the front of the mast as high up as you can reach. This device will help you determine whether the mast is perpendicular or not, or sight your mast with a corner of a building.
2. Adjust upper shrouds so that the mast is straight up and down athwartships, that is, from side to side as opposed to from bow to stern.
3. The upper shrouds should be firm but not bar tight. A 50 pound push should deflect the upper shroud about 1" at shoulder height.
4. The lower shrouds (4 of them) should be adjusted so that they are looser than the upper shrouds. While at the dock they should have no slack but also have no tension on them. No lower shroud when pushed should deflect the mast more than any other shroud when pushed equally hard. If this can't be achieved, the upper shrouds are too tight. Back off one-half turn at a time on the upper shroud turnbuckles until the tension on the lower shrouds is brought into balance.

## FINE TUNING WHILE SAILING

The object of Fine Tuning is to have the mast "in column" (not bent fore or aft or athwartships) when sailing in conditions typical for your area. This is accomplished through adjustments to the lower shroud turnbuckles. Here are some points to look for:

1. When sailing on port tack, sight up the mast from the base. If the middle (where the spreaders are) is sagging to leeward, take up equally on both port lower shrouds until the mast is "in column." Repeat this procedure on starboard tack.
2. If, when sighting up the mast while on port tack, the middle is bent forward (but not to leeward) take up a turn on the port aft lower shroud and let out a turn on the port forward lower shroud turnbuckle. Reverse these adjustments if the middle of the mast is aft of the "in column position."
3. If a perfectly straight mast is not obtained, the mast head (top) may be curved aft and to leeward. The mast head should *never* be "hooked" forward nor to weather.

All rigging wire used on yachts has a tendency to stretch, especially on a new yacht, and after you have sailed in heavier wind than you normally experience. Therefore, you should periodically check the tension on the shrouds and stays, tightening them up if it is required.

Our masts are built to withstand any normal usage but improper tuning or handling can cause problems. Therefore, it is impossible to guarantee the mast of your Catalina 30 under our current warranty program. Rigging, as well as tuning, becomes all important



when setting up the mast. A knowledgeable person should oversee the rigging and tuning so as to eliminate the possibility of an eccentric load which might occur with an improperly loaded shroud. Special attention should be given to the initial stretch of the shrouds and a further gradual stretch of the wire over the first few hard outings.

When making the tuning adjustments while underway, it is advisable to keep the upper and lower nuts on each turnbuckle snug to keep from having the turnbuckle loosen. Upon completion of the tuning, tighten the nuts securely.

ALWAYS, before leaving the dock for a day's sail, check all your turnbuckle nuts for tightness. Also, visually inspect the fittings aloft. **MOST MAST FAILURES HAVE BEEN TRACED BACK TO LOOSENED TURNBUCKLES AND IMPROPER TUNING.**

## **SPAR MAINTENANCE**

Mill finish aluminum surfaces are protected against corrosion by a thin naturally formed film of aluminum oxide. Dust, dirt, smoke, salt and traffic fumes will adhere to this film, making the surface dull and unsightly. Coating the new surfaces with a good paste wax like Vista or Simonize, will help protect the aluminum oxide from foreign matter. If the surface has become tarnished, a good high grade cleaner, wax, or polish will help restore the original sheen. Heavier pitting can be removed by wet-sanding with #600 paper prior to polishing and waxing.

Natural aluminum spars may also be painted. Epoxy and polyurethane paint systems have been specially formulated for use on aluminum spars. The coating manufacturers' instructions should be followed.

## **SPREADERS**

The spreaders are of spruce and have received several coats of varnish. Due to sail chafe and weather, they require some maintenance to remain attractive and prevent deterioration of the wood. They should be sanded and revarnished every six months. At this time the anti-chafing tape at the ends should be replaced and the spreaders checked for rot which might cause spreader fatigue and subsequent mast failure.

## **RIGGING MAINTENANCE**

Salt water will gradually stiffen dacron line. Hosing with fresh water or soaking in warm soapy water will make the line soft and flexible again. Keep coiled and stowed in a dry spot below.

Clean rigging means clean sails. A quick trip aloft with damp rags takes care of this problem. While aloft, check the entire rig for loose screws, nuts, bolts, cotter pins and chafe which may have resulted from hard sailing. Periodic inspection of the rig from aloft is one of your best insurances against rigging and spar failure. Keeping halyards tied away from the mast stops the annoying dockside clanking and saves the mast finish.

# Rigging Specification Schedule C-30

## standard

Description	S.S. Wire Size	L = Length	No. Req'd
Main Halyard	1/8" 7x19	43' - 8"	1
Jib Halyard	1/8" 7x19	46' - 1"	1
Forestay	1/4" 1x19	41' - 6½"	1
Backstay	1/4" 1x19	38' - 5"	1
Forward Lower	3/16" 1x19	21' - 6½"	2
Aft Lower	3/16" 1x19	21' - 10½"	2
Upper Shrouds	1/4" 1x19	40' - 4"	2
Backstay Bridle	1/4" 1x19	5' - 8½"	2
Topping Lift (Option)	1/8" 7x19	38' - 0"	1

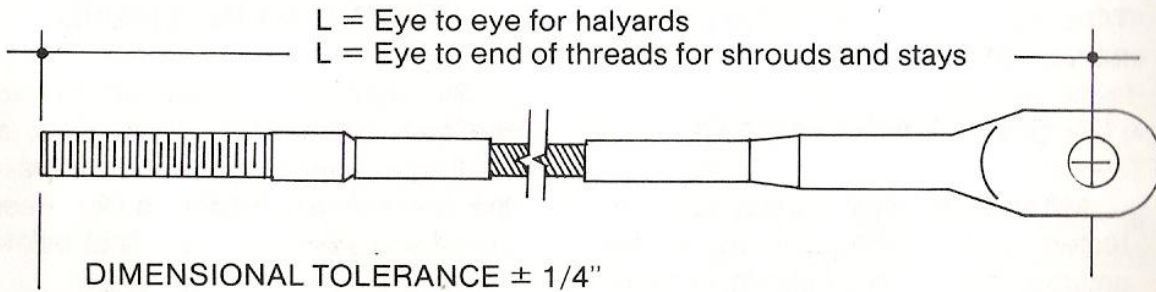

## tall rig

Description	S.S. Wire Size	"L" Length	No. Req'd
Main Halyard	1/8" 7x19	45' - 8"	1
Jib Halyard	1/8" 7x19	48' - 0"	1
Forestay	1/4" 1x19	43' - 2½"	1
Backstay	1/4" 1x19	40' - 6½"	1
Forward Lower	3/16" 1x19	21' - 7"	2
Aft Lower	3/16" 1x19	21' - 10¾"	2
Upper Shrouds	1/4" 1x19	42' - 4"	2
Backstay Bridle	1/4" 1x19	5' - 8"	2
Topping Lift (Option)	1/8" 7x19	40' - 0"	1



# Sail Areas Rig Dimensions C-30

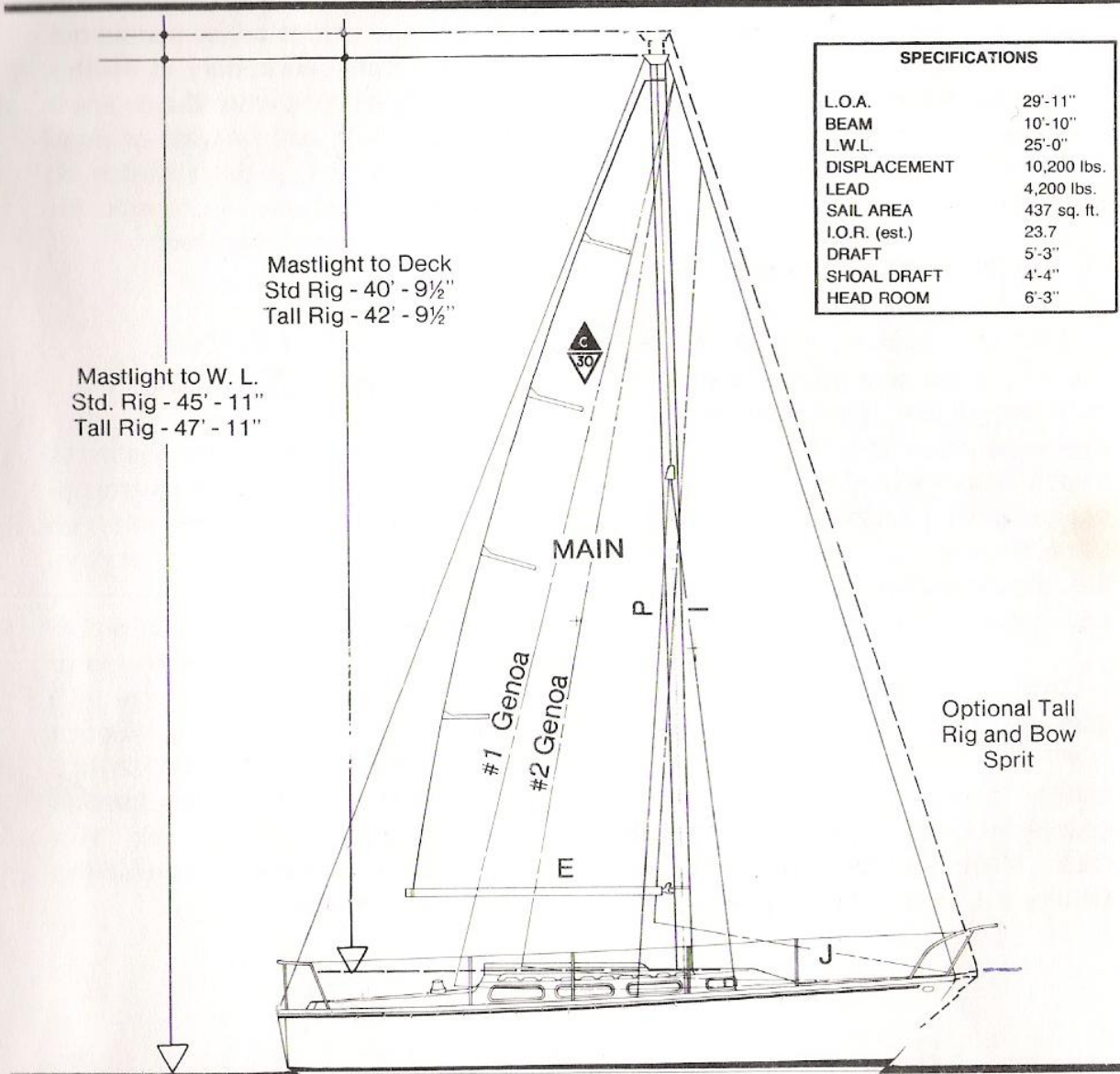

SPECIFICATIONS	
L.O.A.	29'-11"
BEAM	10'-10"
L.W.L.	25'-0"
DISPLACEMENT	10,200 lbs.
LEAD	4,200 lbs.
SAIL AREA	437 sq. ft.
I.O.R. (est.)	23.7
DRAFT	5'-3"
SHOAL DRAFT	4'-4"
HEAD ROOM	6'-3"

	J	I	P	E	Main	100% Fore Δ	#1 Genoa	#2 Genoa
Standard Rig	11.5'	41.00'	35.00'	11.5'	201.25 ♂	238.30 ♂	165% 390.80 ♂	150% 345.00 ♂
(Optional) Tall Rig	13.16'	43.00'	37.00'	12.00'	222.00 ♂	283.15 ♂	170% 482.00 ♂	150% 425.00 ♂



## BATTERIES

Your electrical system is powered by a marine grade 12 volt battery similar to that in your automobile. Attention should be paid to maintaining the proper level of distilled water. Do not overfill.

The battery is provided with a tie-down to prevent its tipping over at extreme angles of heel. Be sure this tie-down is fastened securely.

### MAIN BATTERY SWITCH

Each electrical circuit is fused under a screw cover and spares should be obtained before long cruises. The system is also controlled by a master switch. You should be sure that your boat is free of gasoline fumes before using the electrical system. Always run the blower for at least five minutes before starting the engine.

The circular master switch has the markings 1, 2, and "ALL" as well as "OFF." If you have ordered the extra battery option, you can selectively charge the battery with the engine alternator. Many experienced sailors use Battery # 1 for electrical lighting needs

and keep # 2 in reserve for starting the engine.

When the engine is running, NEVER pass through the OFF position to change from one battery to the other or the alternator diodes will be burned out. Switching from one battery to another should only be done when the engine is stopped. If both batteries are of equal charge, keep the selector switch on ALL position, and use ALL to start the engine if both batteries are low.

### 110 VOLT SHORE POWER SYSTEM

The optional 110 volt AC system is connected to shore power by a grounded, twist-lock-connector mounted on the outside of the port cockpit coaming.

Two twenty-five Amp circuit breakers are located on the aft bulkhead of the galley. Duplex outlets for the 110 volt system are located on both sides of the main cabin. Be certain that all 110 V. appliances, other than lamps, have an adequate grounding connector. Wet feet or moist atmosphere increase the potential shock hazard.

# Main Battery Switch Schematic C-30

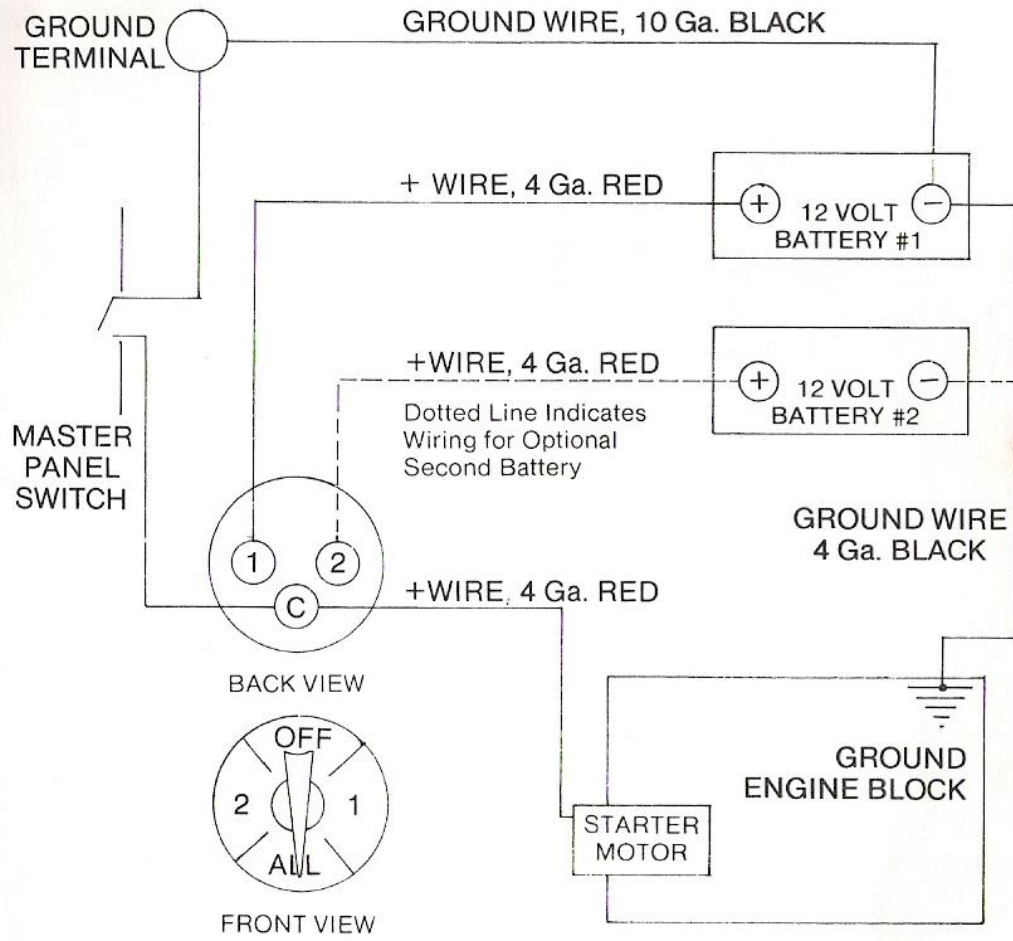

NOTE: DO NOT PASS SWITCH THROUGH "OFF" POSITION WHILE THE ENGINE IS RUNNING



# Wiring Diagram C-30

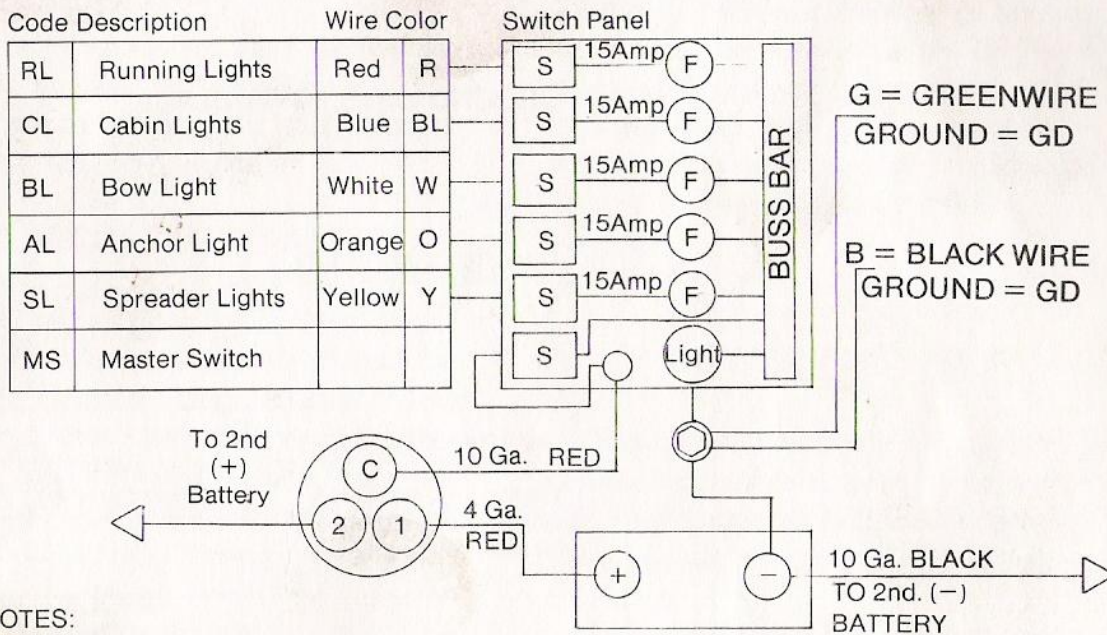

**NOTES:**

- 1 All wire to be 14 Ga. or as specified.
- 2 Green ground wire to be used for all mast fixtures.
- 3 This system has two ground wires,
  - CL and RL are on black wire
  - AL, BL and SL are on green wire

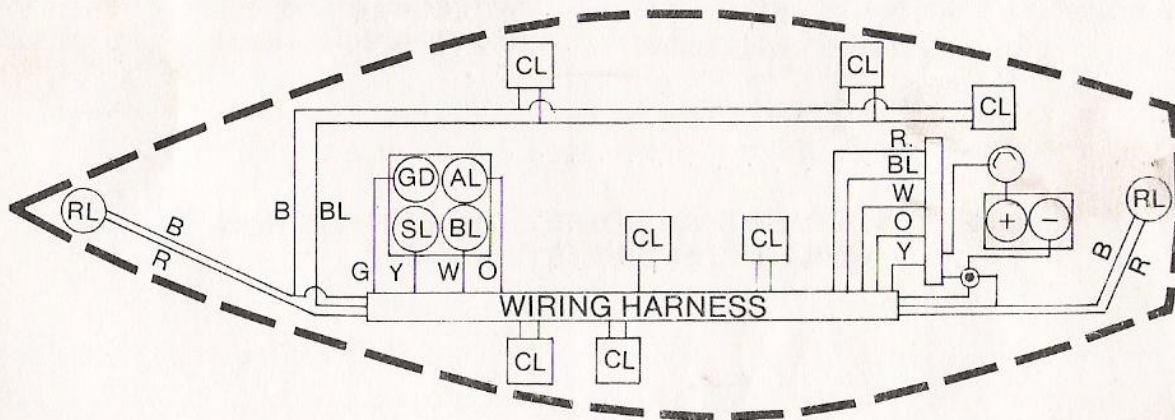

# Wiring Schematic Lamp and Circuit Schedule C-30

## Wiring Schematic

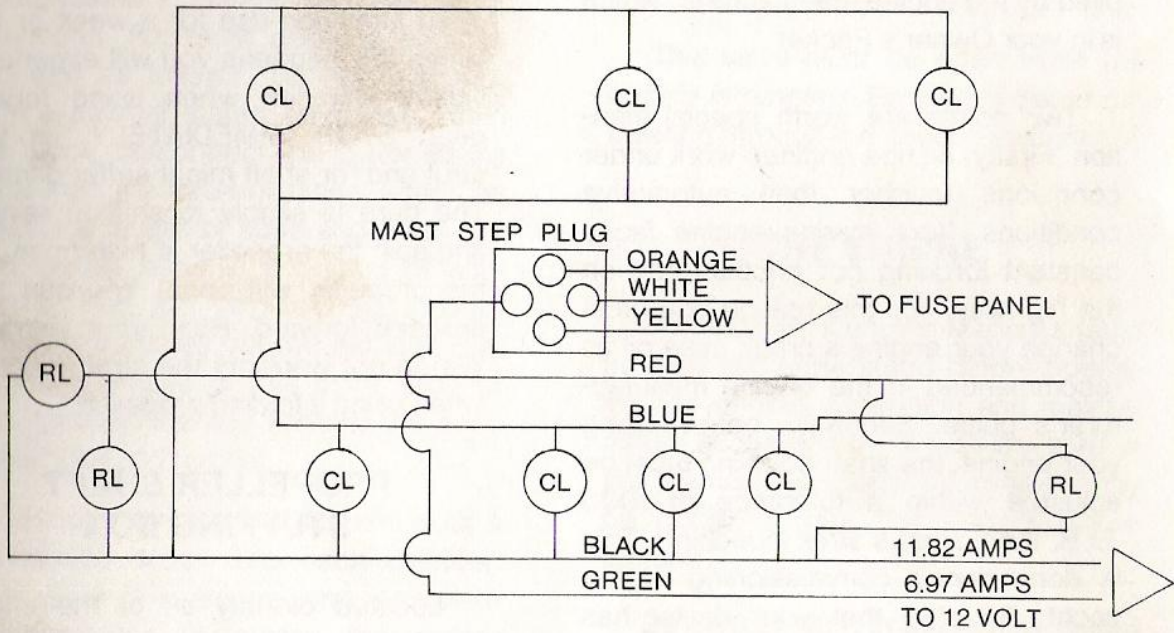

## Lamp Schedule

Color	Code	Description	No. Req'd	Lamp Type	Output Ea.	Amps Ea.	Circuit Amps
Blue	CL	Cabin Light	7	GE 1141	21 C.P.	1.44	10.08
Red	RL	Running Light	3	GE 90	6 C.P.	0.58	1.74
Orange	AL	Anchor Light	1	GE 90	6 C.P.	0.58	0.58
White	BL	Bow Light	1	GE 90	6 C.P.	0.58	0.58
Yellow	SL	Spreader Light	2	Ge 4411	35 W	2.90	5.81



## GENERAL ENGINE USE INSTRUCTIONS

For a complete description of your engine, please consult the guide supplied by the engine manufacturer, which is in your Owner's Packet.

Two points are worth special mention. Firstly, marine engines work under conditions tougher than automotive conditions. Your marine engine faces constant torquing not encountered on the highway. For this reason you must change your engine's crank case oil as recommended in the engine manufacturer's guide. Secondly, before using your engine, the shaft coupling must be adjusted within a tolerance of .003 T.I.R. thousandths *after* launching. This is done during commissioning of the yacht. Be sure that your dealer has made this adjustment before using your engine.

Change oil regularly. Keep spare spark plugs and alternator belt on hand and use only 2/3 to 3/4 throttle on long passages. Keep your fuel tank full whenever possible to prevent water condensation in your fuel tank.

To retard electrolysis we recommend installing a zinc collar *immediately* on the propeller shaft.

## ENGINE COMPARTMENT BLOWER

In order to clear any dangerous fuel fumes from the bilge, run the blower for five minutes prior to starting the engine. The switch is on the master panel. The blower discharges out through the deck vent and is directly under this vent. The blower unit is located in the port side of the stern locker.

## FOLDING PROPELLER

If your boat is equipped with a folding propeller, then you should pay attention to the following point. It is not uncommon for folding propellers to fail to open after non-use for a week or two. When this happens you will experience violent vibration when using forward gear. STOP IMMEDIATELY, as your strut and/or shaft might suffer damage. The cure is simply to shift to reverse and spin the propeller at high r.p.m. and the propeller will open. You can then proceed forward. Read your warranty. We do not warranty the strut and shaft when using a folding propeller.

## PROPELLER SHAFT STUFFING BOX

Located directly aft of the engine compartment beneath the cabin sole hatch is the thru-hull fitting for the propeller shaft. The propeller shaft stuffing box compresses several rings of grease impregnated flax and creates a water-tight seal around the propeller shaft. The stuffing box should be damp at all times. Be sure the nuts are just snug enough to eliminate any excessive water drips.

## WINTERIZING THE ENGINE, GENERAL NOTES

We recommend the following procedures be followed when storing the yacht for prolonged winter periods. Begin by consulting your authorized dealer about storing the boat in or out of water in freezing climates. If at all possible, the manufacturer recommends keeping the yacht in dry storage for severe winters.

All thru-hull fittings should be drained and closed off. Water in the sanitation system and other tanks should be



pumped out. Fill the lines and fittings with antifreeze to prevent water from running in, freezing, expanding, and cracking the lines and fittings.

For diesel engines, consult the manufacturer's manual for special instructions. For most gasoline engines proceed as follows: Unless manufacturer's manual states otherwise, drain the block, disconnect the water intake hose from the thru-hull fitting, attach an additional length of hose and place the end of this hose in a bucket of anti-freeze. Run the engine until straight anti-freeze comes out the exhaust line. Stop the engine at this point, plug or cap exhaust line and remove the additional hose and bucket.

Remove the spark plugs and pour a tablespoon of oil into each cylinder. Turn over the engine one complete revolution by "bumping" the starter briefly. Replace the spark plugs.

## THE FUEL TANK

The fuel tank for gasoline and diesel engines is located beneath the aft double berth. The tank is an 18 gallon, BIA approved type, of aluminum construction. A deck fuel fill plate is mounted on the port side deck. The tank vent is located on the starboard side of the transom.

A fuel shut-off valve is located on the fuel feed line on the top of the tank. The valve should remain closed when the engine is not in use. The valve is closed when the handle is perpendicular to the direction of the hose; the valve is open when the handle is parallel to the direction of the hose.

A partially filled tank can cause condensation of water inside the tank which will contaminate the fuel. To avoid water in the fuel, it is advisable to keep the tank full.

## THE COOLING WATER INTAKE

The cooling water intake is located in the engine compartment on the port side, slightly forward of the engine block.

This valve *must be open while the engine is running*. Be sure water is circulating through the cooling system.

## THE ENGINE

The supplier's engine Manual should be read and understood before operating the engine. Operation and maintenance of the engine is well covered in the Manual. Additional information may be obtained from the engine manufacturer.

Be sure to send in the engine manufacturer's warranty card within the period specified by the engine manufacturer.

## ENGINE CONTROLS

Periodically check the engine throttle, shift and stop run lever controls. The cockpit control unit should be examined from behind, inside the port cockpit locker. Check the mounting bolts and cable connectors. Also check the control cable attachments at the engine. Normal vibration can loosen the control connections and cause a loss of control under power.

You may remove the battery and keep it out of freezing temperatures or keep it fully charged at all times to prevent freezing.

Your engine should now be ready for winter lay-up conditions. Please check with the yard for additional information.



## SEACOCKS

All underwater thru-hull fittings are equipped with gate valves. It is good practice to close all gate valves when leaving the boat, especially for extended periods of time.

To close seacocks, turn clockwise; to open, turn counter-clockwise.

It is good practice to operate the gate valves at least once a month to keep them in good working order. Check the packing glands on all gate valves to avoid water seepage.

## MARINE HEAD OVERBOARD DISCHARGE

Boats manufactured before January 31, 1977, may have an overboard discharge marine head. The toilet is supplied with servicing instructions. Operation instructions are printed on the toilet pump housing. Read the instructions thoroughly and be sure that all persons who might be using the head understand its operation. Parts and spares may be obtained directly from the toilet manufacturer or your servicing Catalina dealer.

The marine head thru-hull valves should be kept closed when not operating the head to avoid the possibility of water entering the boat due to failure of the internal toilet valve.

## HOLDING TANK

The optional 18 gallon plastic holding tank is emptied through a deck mounted fitting marked as "WASTE." The tank is located beneath the port main cabin settee. The holding tank should be emptied only at approved waste pump out stations.

## SHOWER SYSTEM

Water for the shower is supplied by a separate 18 gallon plastic tank located beneath the starboard berth in the forward cabin. The water supply pump is located behind the access hatch at the foot of the center V berth riser in the forward cabin. The supply pump is activated by a gasketed water-resistant toggle switch located in the shower area. **DO NOT RUN THE SUPPLY PUMP WHEN THE TANK IS EMPTY.** The shower pan drains into the main cabin bilge and should be emptied immediately after or during use of the shower by operating the main bilge pump.

## GALLEY AND HEAD FRESH WATER SUPPLY

The galley and head are supplied by a 23 gallon polypropylene water tank located under the port main cabin settee. The tank is filled through a deck fill plate located on the port side deck. The cap is labeled "Water."

Both galley and head sink drains are fitted with seacocks and should be kept closed when the boat is left for extended periods or when sailing.

## MANUAL BILGE PUMP

The manual bilge pump is located in the port cockpit locker. The handle is stored in a clip fitting just above the pump inside the locker. Insert the handle through the water-tight fitting in the cockpit to operate the pump.

The pump intake hose is in the keel stub under the main cabin sole. The bilge pump should be operated after each time the shower is used.



## FIRE EXTINGUISHERS

It is wise to locate a minimum of two, approved for marine use, fire extinguishers, one forward of the galley and one behind the galley, preferably below the cockpit hatch. Should an alcohol stove or engine fire start, you can always reach a fire extinguisher depending upon your location. For instance, you do *not* want to locate *both* of your extinguishers in the head area because if you are located in the cockpit, you will have to pass the danger area to reach them if the fire is either in the galley or engine area.

Dry chemical extinguishers should be inverted occasionally to prevent the contents from packing. Extinguishers should be recharged yearly or after each use, according to manufacturer's recommendations.

## GALLEY STOVE

There is provision for a gimballed stove with oven on the port side of the galley area. A two burner pressure alcohol stove with oven is the normal factory option installation and comes with an operation and maintenance booklet provided by the stove manufacturer. A few additional points on stove operation are unique to your Catalina 30.

The 2 gallon pressure tank is located in the cockpit stern locker. When filling this tank, please observe the following BEFORE removing the stopper:

1. All burners are OFF.
2. Main Alcohol Shut-off Valve on top of pressure tank is CLOSED.
3. Tank pressure is ZERO: Remove stopper.
4. Fill the tank three-quarters full to allow for air pressure.

5. Replace stopper and screw down tight.

6. Experience has shown that 5 pounds of tank pressure is more than adequate and imposes less strain on the fittings than the recommended 10 pounds.

Remember, alcohol is a relatively safe marine stove fuel; however, flare-ups can occur, especially during priming. As an additional safety precaution, you may wish to keep a large pot or bucket of water on the stove or nearby which can be used to extinguish an alcohol fire.

Follow the manufacturer's instructions carefully and be sure that persons who may be using the stove fully understand its operation.

## ANCHORS AND ANCHORING

The manufacturer suggests an anchor in the 13-16 pound range and of the "danforth type" to be used as a bow anchor in ordinary conditions. This anchor will only be effective with at least 20 feet of 1/4 inch or heavier gauge chain and at least 200 feet or more of 7/16" or heavier nylon line. An 8 pound stern anchor will require about 150 feet of scope and 15 feet of chain.

Under adverse weather conditions as much as a 25 pound bow anchor could prove necessary, and possibly a plough-type anchor might be required.

Inquire in your local area about anchoring procedures relative to the place you plan to visit. Get the opinions of several experienced people and always play it on the safe side in "making up" your anchor and in using it. Do not forget to wire all shackle pins so they cannot come loose under water.



Remember: Lighter anchors are made more effective by increasing the scope, i.e., the ratio of length of line and chain to depth of water.

A 7:1 ratio is recommended. This means using 7 feet of anchor line for each foot in depth of the water.

### **ANTI-FOULING BOTTOM PAINT**

Anti-fouling paint should be applied to the bottom of your Catalina 30 if it is to be moored in either fresh or salt water for any length of time. There are many brands available. Anti-fouling paint prevents the growth of algae, barnacles and other fouling organisms on underwater surfaces. If this paint has been applied at the factory, no action is necessary at the time of launching.

The anti-fouling paint used at the factory is a vinyl-base copper bearing type available either in red or blue. For those owners who apply anti-fouling paint themselves, it should be noted that most brands require all underwater fiberglass surfaces to be very carefully sanded and primed immediately prior to the first application on a new boat. In any event, the instructions of the manufacturer of the brand of paint used should be followed.

### **PARTS AND ACCESSORY ORDERS**

Catalina's interest in both customer and product continues long after you have commissioned your Catalina 30. Within the limits of our specifications, the company's Parts Department is ready to serve your nearest dealer quickly and efficiently. All replacement parts or accessories are delivered through your dealer. He must have detailed information from you to be certain we send the parts required.

### **CLOSING WORDS**

The builder would like to take this opportunity to wish you season after season of sailing enjoyment in your new Catalina 30.

We have prepared these texts with that goal in mind, believing that knowledge of the boat and awareness of safety procedures will lead to increased sailing pleasure for you and your family. Take care of your boat and take the time to learn and practice good seamanship.

CATALINA YACHTS

## PRE-USE CHECK LIST

### BEFORE LEAVING THE DOCK OR MOORING:

1. Visually inspect the standing rigging. Be sure that turnbuckle nuts are tight or cotter pins secure and covered to prevent chafe, halyards are free and not tangled.
2. Make up the anchor and line. These should be ready for immediate use, stored on deck or in the forward anchor locker.
3. A throwable, approved life saving device should be on deck, available to the helmsman, in accordance with Coast Guard recommendations.
4. Set battery selector switch. (Do not change when motor is running.)
5. Operate engine compartment blower approximately 5 minutes.
6. Sniff bilge area for fuel fumes. Operate the blower for a longer period if necessary. If odor persists, there may be a leak in the fuel line or fuel in the bilge. **DO NOT START THE ENGINE** until the problem has been discovered and fixed.
7. Test running lights.
8. Check water tank.
9. Open engine cooling water intake valve.
10. Check fuel tank level.
11. Check engine oil level in accordance with manufacturer's recommendations.

12. Check exhaust after engine is started. Be sure a flow of water is being expelled. If no water is coming out, the intake valve may be clogged. Shut off the engine immediately.
13. Secure loose objects on deck and below.
14. Remove main cabin table from bulkhead storage position before sailing.

### BEFORE LEAVING THE BOAT:

1. Close all thru-hull valves.
2. Close fuel tank valve.
3. Close all thru hull valves
4. Any salt spray should be rinsed from the deck and rigging with fresh water to prevent corrosion and preserve the finish.
5. Relieve pressure in stove fuel tank if fitted.
6. Leave ice box lid ajar for ventilation.
7. Check bilge water level, pump if necessary.
8. Set battery selector switch to "off."
9. Check mooring or docklines for secure attachment.
10. Tie off halyards to shrouds to prevent unnecessary noise and preserve mast finish.



