

OWNER'S MANUAL
BENETEAU 423

HULL IDENTIFICATION NUMBER:
US-BEY _ _ _ _ _

OWNER'S MANUAL BENETEAU PART #: 112284

SUMMARY:

I)	INTRODUCTION	3
II)	ANTI-FOULING	4
III)	WARRANTY	5
IV)	HULL IDENTIFICATION NUMBERS	7
V)	DEALER'S RESPONSIBILITIES	7
VI)	OWNER'S/OPERATOR'S RESPONSIBILITIES	8
VII)	SAFE OPERATION AND WARNING LABELS	12
VIII)	FEDERAL REGULATIONS	17
IX)	COMMISSIONING	20
X)	SPECIFICATIONS OF THE BOAT	24
XI)	INTERIOR LAYOUT	26
XII)	DECK	28
XIII)	SAILS AND RIGGING	29
XIV)	FRESH WATER SYSTEM	43
XV)	BILGE PUMP SYSTEM	46
XVI)	SEACOCKS AND THRU-HULLS	48
XVII)	ELECTRIC SYSTEMS	50
XVIII)	LP GAS SYSTEM	60
XIX)	STEERING SYSTEM	62
XX)	ENGINE	63
XXI)	HANDLING	64
XXII)	MAINTENANCE	65
XXIII)	WINTERIZING PROCEDURES	71
XXIV)	ENVIRONMENT	76

EXPLANATION OF THE TYPOGRAPHY USED:

DANGER

WARNING

TAKE CARE

D) INTRODUCTION

Many parts and systems installed on your boat are supplied by other manufacturers and each carries a specific warranty and may require specific care. This manual supplements the literature supplied with the various equipment and we will refer to manufacturer's literature throughout this booklet. We recommend referring to original manufacturer's literature whenever possible.

This manual is broken down into several sections that attempt to help explain your boat, your warranty, responsibilities as an owner, and maintenance of your new Beneteau. The systems and procedures described in this manual were correct to the best of our knowledge at the time of printing and may be changed at any time or may have been changed on your boat. While we have tried to describe the major points of your boat within this book, we cannot cover every detail. Owning a boat and the operation of it are complex issues that can only be mastered by vast experience and professional assistance. Please call your dealer or feel free to call us if any question should arise.

If you are a seasoned sailor much of the manual may be old news, and if this is your first boat, we hope this will prove useful, but we advise you to seek out professional instruction through your dealer, sailing schools, the US Coast Guard auxiliary, US Power Squadron, etc.

Should you need to contact Beneteau please use the following addresses and numbers, be sure to include your model and hull number with any correspondence.

Beneteau Customer Service
(Customer Service Dept.)
1313 Highway 76 West
P.O. Drawer 1218
Marion, SC 29571
Tel (843)-423-6459
Fax (843)-423-5516

Beneteau USA Inc.
(Sales & Marketing)
24 North Market Street, Suite 201
Charleston, SC 29401
Tel (843)-805-5000
Fax (843)-805-5010

We would like to sincerely thank you for choosing a Beneteau and we wish you good sailing.

NOTE: Specifications, dimensions, capacities and descriptions are estimations given for general information purposes, and they are not contractual in nature.



II) ANTI-FOULING

The primary function of your Beneteau is to maximize your boating pleasure. Your new Beneteau was made to last for many years. From the very beginning, care has been taken in building your boat. Your years of pleasurable ownership are dependent upon proper care and preparation.

Between the gel coat and the fiberglass laminate, Beneteau applied a Vinylester resin that greatly reduces the phenomenon of osmosis and osmotic blistering. All materials used in the construction of your Beneteau are of high production quality. Sampling of materials and operational standards are monitored so that the structural design matches the engineered standard. This, coupled with the mastery of building techniques, allows Beneteau USA to offer you one of the most favorable structural warranties in the marine industry.

Methodology for anti-fouling application when new:

1. Clean and degrease hull thoroughly using a denatured ethyl alcohol
2. Sand hull using sandpaper with a minimum grit of #220. (i.e., 220, 300, or 400)
3. Rinse with fresh water.

DO NOT USE DETERGENTS. DO NOT PRESSURE WASH.

4. **APPLY ANTI-FOULING TO MANUFACTURER'S DIRECTIONS.**

NOTE: It cannot be emphasized enough that thorough de-waxing must occur. Furthermore, if the gel coat is abraded with coarse sandpaper, the water imperviousness will be destroyed, and the warranty might be voided.

III)

LIMITED WARRANTY

Beneteau USA Inc. ("Beneteau USA") warrants to the original purchaser or any subsequent buyer during the time of this Limited Warranty (the "Owner"), that the boat, excluding parts or accessories not manufactured by Beneteau USA or Chantiers Beneteau, S.A., will be free from defects in material and workmanship for a period of ONE year from the date of the delivery to the original purchaser.

In addition, Beneteau USA warrants to the Owner, except for the prototypes and boats from the California series, that the hull and deck structure of the boat will be free from defects in material and workmanship for a period of FIVE years from the earliest of the following events: delivery of the boat to the original purchaser, first date of utilization, last day of the boat model year.

Beneteau USA's obligation under this warranty shall be limited to the repairing or replacing (or causing to be repaired or replaced), at Beneteau USA's option, the part or parts which are recognized defective by it in material or workmanship within the applicable warranty period to the exclusion of all other remedies. This Warranty shall apply only provided that the Owner presents the boat's Certificate of Origin and gives the selling dealer written notice of any claimed defect within 15 days after such defect is first discovered and satisfactory proof thereof. Warranty repairs do not result in a renewal or extension of the original Warranty for the boat or a part thereof. Transportation charges and duties shall be borne by the Owner.

This Warranty does not extend to: (1) any losses due to misuse, accident, disaster, abuse, neglect, normal wear and tear or improper maintenance; (2) boats or any part thereof which have been repaired or altered without Beneteau USA's prior written approval; (3) accessories or parts not supplied by Beneteau USA or Chantiers Beneteau, S.A., or parts or accessories installed during the process of manufacturing that were not manufactured by Beneteau USA or Chantiers Beneteau, S.A., for which the Warranty will be the one provided by the supplier of the part or accessory; (4) damages resulting from any modification made to the boat; (5) boats for rental, lease, or charter; (6) splits, discoloration, or cracks in the gel-coat (hull, rudder, and deck); (7) disorders in the hull, or deck such as, without limitation, blisterings, which are caused by use of improper maintenance products or by improper sanding of the gel-coat; (8) anti fouling, varnishes, paints, acrylon, naugahyde, fabrics, headliners, chrome, anodized coatings, keel coatings, sails, cushions, or running rigging, as these items are subject to deterioration caused by climate, erosion, normal use conditions, or wear and tear; (9) reasonable and necessary maintenance, including, but not limited to, periodic re-bedding of chain plates, stanchion bases, windows and/or window frames, and winches; (10) damages or deterioration due to the non-observance of maintenance recommendations as described in the owner's manual or non-compliance with the normal rules of boat maintenance; (11) failure to take reasonable measures necessary to protect the boat; (12) any damage or deterioration to the boat resulting from participation in a competitive sporting event.

In addition, if (1) any structural damage to the boat is suffered as a result of any cause other than a defect in material or workmanship (whether or not such damage requires or results in any repairs to the hull or deck), or (2) any repairs or alterations to the boat of any nature whatsoever are made at a shipyard not approved in writing by Beneteau USA, then the five-year hull/deck Warranty set forth above will immediately thereupon terminate and be of no further force or effect.

THIS WARRANTY IS EXPRESSLY IN LIEU OF ALL OTHER WARRANTIES EXPRESS OR IMPLIED INCLUDING WITHOUT LIMITATION THE IMPLIED WARRANTIES OF MERCHANTABILITY OR FITNESS FOR A PARTICULAR PURPOSE AND ALL OTHER LIABILITIES ON BENETEAU USA'S PART, AND BENETEAU USA NEITHER ASSUMES, NOR AUTHORIZES ANY PERSON, INCLUDING THE DEALER, TO ASSUME FOR IT, ANY OTHER LIABILITY IN CONNECTION WITH THE SALE OF BENETEAU USA'S BOATS.

Beneteau shall in no event be liable to the Owner or any other person or entity for damages of any kind, including but not limited to direct, indirect, special or consequential damages, arising from the sale or in connection with the use or inability to use the boat for any purpose whatsoever, irrespective of whether the claims or actions for such damages are based upon contract, tort, negligence, strict liability, warranty, or otherwise.

For the purpose of compliance with the Federal Boat Safety Act of 1971 and all notification procedures set forth therein, Beneteau USA requests that you complete the information requested below concerning your current address, which shall be returned to Beneteau USA by your Dealer.

Beneteau USA reserves the right, at any time, to make changes in design or additions to or improvements in the boats without liability or obligation to incorporate such change, addition, or improvement in any boat manufactured prior thereto.

This Warranty gives you specific legal rights. You may also have other rights which vary from state to state.

I hereby acknowledge that Beneteau USA Inc. Limited Warranty was attached to Dealer's purchase order in its entirety at the time that I purchased my boat from said Dealer; that I have read such Limited Warranty in its entirety; and that I have a copy of such Limited Warranty, as attached to Dealer's purchase order, for future reference.

_____	Boat Model _____
Signature _____	Hull # _____
Purchaser's Name/Please Print Clearly _____	Dealer _____
Mailing Address of Purchaser _____	_____
City State Zip _____	Date _____
(Area Code) _____	Telephone Number _____

WARRANTY/REGISTRATION PROCEDURES

Warranty Procedure

Beneteau boats, unless specifically excluded, carry a one year limited warranty, as well as an extended hull and deck structural warranty (see official warranty form for details). As the first owner of your new Beneteau, your warranty only becomes valid upon receipt, by Beneteau, of the completed and signed warranty form. **It is important that you were presented with this document at the time of your contract with your dealer and that both you and your dealer have signed this form. Your warranty will then take effect upon delivery to you of your new Beneteau.**

Registration Procedure

As a new Beneteau owner you will automatically become a member of Club Beneteau. Club Beneteau will entitle you to many added benefits and advantages as well as providing you with a valuable line of communication with Beneteau. We will forward a new owner's package directly to 30 day after receipt of the completed and signed warranty form from your dealer.

Subsequent owners of Beneteaus are invited to become a member of Club Beneteau as well. We will automatically enroll these boat owners upon receipt of their warranty transfer cards.

In the event that you change your address, please fill out and mail in the change of address card at the back of the manual (to the address below) so that you will not miss any of Club Beneteau's opportunities. You can also find a change of address form on line under CLUB BENETEAU at www.beneteauusa.com.

If you have any questions concerning this procedure please feel free to contact Beneteau Customer Service at (843) 805-5000.

Warranty Transfer

For a period of five years from date of manufacture, your new Beneteau has a transferable, limited hull and deck warranty. In the event of selling your Beneteau, the new owner must be registered with Beneteau within 30 days of the date of sale for the warranty to be transferred.

Please fill in the appropriate warranty registration card at the back of this owner's manual and mail it to:

Beneteau USA Inc.
24 North Market Street
Suite 201
Charleston, SC 29401

IV) HULL IDENTIFICATION NUMBERS

The hull identification or "BEY" number is a unique number given to your Beneteau alone. This number begins with "BEY" which has been assigned to Beneteau by the USCG followed by an alpha-numeric code which details the model, serial no., month of construction, year of construction and model year.

Please clearly identify your boat using your model and "BEY" number during any correspondence with Beneteau.

Your boat identification number appears in two places:

The main hull identification number is located on the aft starboard side, near the transom, stamped into the hull, approximately 3 inches below the toerail.

The second hull identification number is in a hidden area for anti-theft purposes.

V) DEALER'S RESPONSIBILITIES

Your Beneteau Dealer is an independent sales agency and they are a part of a worldwide distribution network, with dealers in 28 countries. A Beneteau Dealer, has certain obligations to you as the customer and to Beneteau as an authorized sales agency. A Dealer's responsibility does not end with the sale of your boat. Your Dealer is responsible for the following:

- Delivering your new Beneteau to you complete, as ordered in your purchase agreement.
- Preparation of your boat for commissioning by their personnel, or another boat yard contracted by them to accomplish the correct commissioning procedures.
- Checking of all systems on the boat for fit, proper function and to familiarize you with the usage of each system.
- Sea trial of your new Beneteau with you as a final verification that all systems are in good order.
- Providing customer support and spare parts after you take delivery and any warranty service under the terms of the limited warranty. All warranty questions/claims or processing should be directed through your dealer.

VI) OWNER'S/OPERATOR'S RESPONSIBILITIES

STATE REGISTRATION OR FEDERAL DOCUMENTATION

For State Registration please consult your Dealer or the State offices in charge of boating, who can provide the correct governmental department handling registration in your state. Your Dealer also should be able to advise you on the possibility of Federal Documentation with the US Coast Guard.

SAFETY AND MAINTENANCE

For maximum enjoyment of your Beneteau, due respect should be given to proper safety and maintenance procedures.

Be sure that your boat is operated according to the U.S. Coast Guard Regulations as outlined in the "Federal Requirements for Recreational Boats". Please familiarize yourself with all operating requirements.

Prepare yourself for any situation before going out on the water. Follow the instructions provided in the sections of this owner's manual, the individual supplier instruction manuals, and all applicable U.S. Coast Guard and other regulations. If you are not an experienced sailor, you should complete an accredited sailing course.

Before leaving the dock, be sure that all your equipment is in working order, that you are aware of the weather conditions, and someone ashore is familiar with your destination or sailing activities.

MANDATORY COAST GUARD SAFETY EQUIPMENT

Many safety items are required for compliance with the U.S. Coast Guard regulations. Note that these regulations are subject to change. It is the owner's responsibility to be aware of current regulations as outlined in the "Federal Requirements for Recreational Boats". For your convenience a copy is included with your yacht's documentation, and additional copies may be obtained by calling the U.S. Coast Guard Boating Info line at (800) 368-5647.

Good safety equipment should be a priority of every sailor for the protection and comfort of passengers. Passengers aboard should be made familiar with the safety equipment and operation of the boat in the event of an emergency.

Depending on the length, passenger capacity, and operating conditions, your boat must be equipped according to the current USCG requirements. Be sure that you operate your boat with the necessary number of life preservers, fire extinguishers, signaling devices, distress signals, navigation lights as referred to in the "Federal Requirements for Recreational Boats."

RECOMMENDED SAFETY EQUIPMENT

Preparation is the key to safety on the water.

Your new Beneteau has been fitted with the following equipment:

- Compass - be sure that it is properly calibrated to give the correct magnetic reading.
- A large capacity bilge pump.

We recommend that you fully outfit your Beneteau with safety equipment that can be obtained through your dealer or marine supply outlets. These items should include but not be limited to:

- Up to date nautical charts covering your intended cruising area.
- Boat hook.
- Large waterproof flashlight with spare batteries.
- Fenders.
- Docking lines - a good rule of thumb to follow dictates that your bow, stern, and spring line be equal to the length of the boat.
- Life jackets, anchor, anchor chain and line, throwing line, flares, soft wooden plugs for thru-hulls, life ring, fire extinguisher, and foghorn.
- Electronics - Depth Sounder, Log Speedometer, and VHF Radio.

SAFETY COURSES

It is recommended that owners and operators gain knowledge and experience in boat safety skills such as:

- (a) Navigation
- (b) Seamanship and boat handling
- (c) Rules of the road, international and inland waterway
- (d) Weather prediction
- (e) Safety at sea
- (f) Survival in bad weather
- (g) Respect for others on the water
- (h) First aid
- (i) Radio communication
- (j) Distress signals
- (k) Pollution controls

To find out where one can attend these courses in your area, please call your dealer or "The Boaters Educational Course Line" at (800) 336-2628.

ANCHORING

Various sea and bottom conditions require different anchoring systems. Your dealer can help in choosing rode size and length, anchor chains, and working and storm anchors most appropriate for your boat and location.

In general, a minimum of two anchors should be carried at all times and enough anchor rode and chain necessary for the depth of water to be navigated during storm conditions.

Certain anchors are useful for a variety of bottom conditions. Study the charts of the area to be navigated for information concerning bottom conditions and water depth.

The greatest hazard with a sound permanent mooring is chafe, which can occur to the rode at the bow chocks. This is the single most common site of failure. Care is advised in the selection and protection of the rode pennant with appropriate chafing gear. Careful and regular inspection of moored boats on a regular basis is necessary to ensure the boat's safety.

ADDITIONAL SAFETY EQUIPMENT

A number of additional safety items are worthy of your consideration. These range from safety harnesses to emergency beacons, life rafts, and survival suits. Their use depends upon the intended use of the yacht. We suggest you investigate the necessity of these items through discussion with your dealer or local chandler.

MEDICAL KIT

Every yacht should carry a first aid manual, and a medical kit tailored to the specific needs of the owner. Any ship's store should carry a standard type medical kit. Items in the kit should include but not be limited to the following:

- Aspirin
- Adhesive strips and tape
- Antiseptic wipes
- Gauze bandages
- Sunscreen first aid/burn cream
- Sterile pads
- Ace bandages & splints
- Motion sickness pills
- Ammonia inhalants
- Antiseptic germicide ointment
- Zinc oxide ointment
- Insect/bee sting relief ointment/spray
- Cold packs for sprains
- Scissors & tweezers

TOOL KIT

A basic kit should consist of:

- Wrenches - adjustable, Metric and SAE open end, box, socket
- Hammers - large and small
- Knife - with marlinespike
- Screwdrivers - large and small, standard and Phillips
- Pliers - regular, cutting and needle nose, vise grips
- Wire cutter - capable of cutting standing rigging
- Hacksaw - with spare blades

SPARE PARTS

A basic kit should consist of the following:

- Standing and Running Rigging: Turnbuckles, monel seizing wire, clevis and cotter pins, shackles, blocks, extra line, rigging tape, duct tape.
- Fasteners: Assortment of stainless steel screws, nuts, bolts, and washers
- Hose clamps.
- Electrical: Electrical tape, wire, crimps on lugs, spare navigation light bulbs.
- Lubricating supplies: WD-40 and silicone grease.
- Engine: Check engine manual for spare parts, engine oil and transmission fluid recommendations.
- Sails: Sail repair kit and sail slides.

VII) SAFE OPERATION AND WARNING LABELS

Ensure that the boat operator is not under the influence of drugs and/or alcohol.

Do not venture out in weather or sea conditions beyond the skill or experience of the operator.

There are "Warning" and "Caution" statements affixed to your Beneteau. These are detailed below with location:

FUEL WARNING LABEL

- Affixed to the fuel tank.

Beneteau Part #111358



SHORE-POWER LABEL

- At the 110V distribution panel.

Beneteau Part #111359

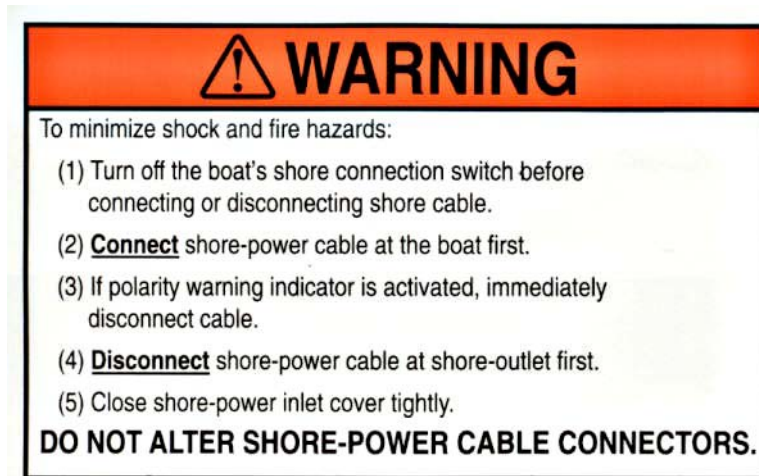

PROPANE LABELS

- At the propane stove affixed to the bulkhead in the galley

Beneteau Part #111353

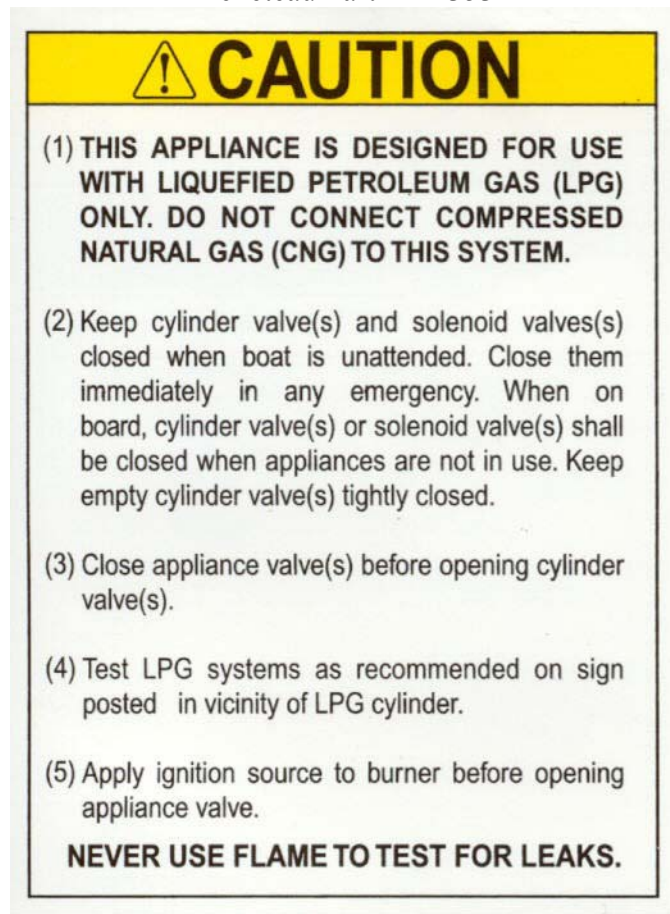

Beneteau Part #111357



- In the propane locker affixed under the propane locker lid

Beneteau Part #015903

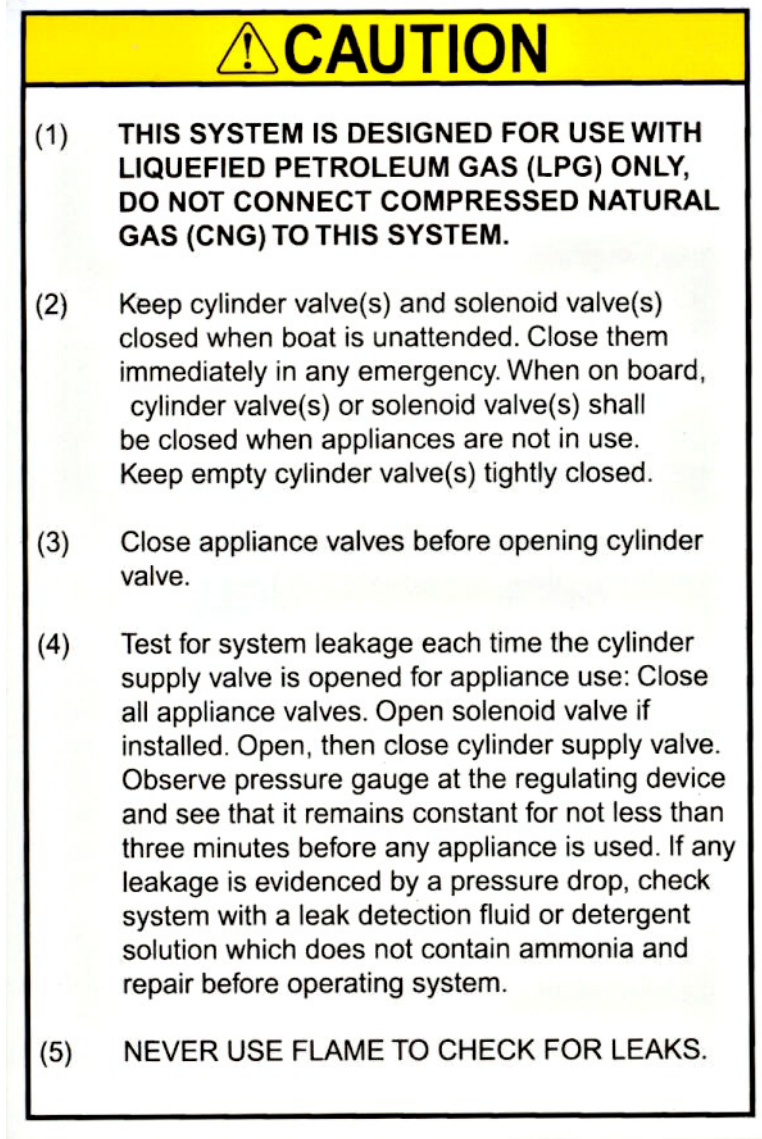

- On or next to the LP Gas Line

Beneteau Part #111361



SWIM LADDER WARNING LABEL

- Located on the transom

Beneteau Part # 111354



HIGH VOLTAGE WARNING LABEL

- Located beside the 110v electric panel.

Beneteau Part #111365

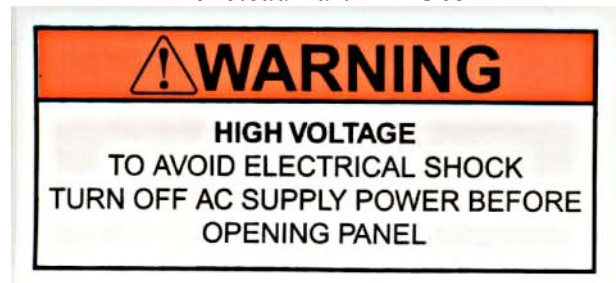

TRANSOM DOOR WARNING LABEL

- Located on or next to the helmsman's seat. (Not applicable on all models)

Beneteau Part #111362



STANDARD BATTERY SWITCH LABEL

- Located at the standard battery switches.

Beneteau Part #111363



OPTIONAL BATTERY SWITCH LABEL

- Located at the optional battery switches

Beneteau Part #111300 (Not applicable on all models)

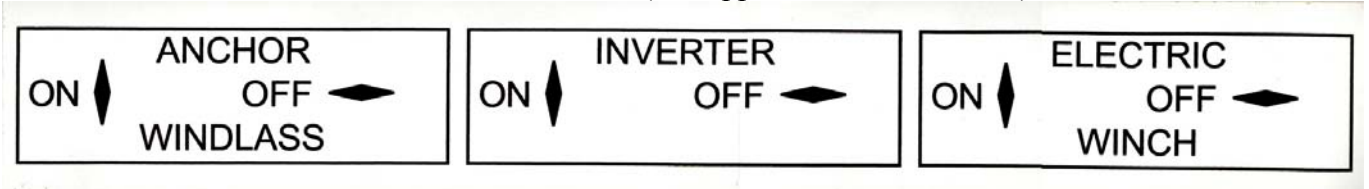

SLING LOCATION ARROWS LABEL

- Located at or near the hull to deck joint

Beneteau Part #111364

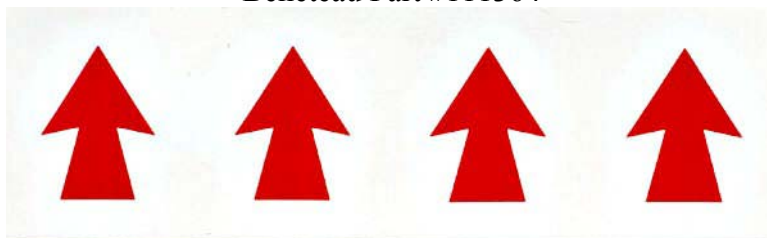

ANTI FREEZE CAUTION TAG

- Tied to the breaker for the water

Beneteau Part #111046



VIII) FEDERAL/STATE REGULATIONS

DISCHARGE OF OIL

- Located: under the sail locker lid.

Beneteau Part #111352

DISCHARGE OF OIL PROHIBITED

The Federal Water Pollution Control Act prohibits the discharge of oil or oily waste into or upon the navigable waters of the United States or waters of the contiguous zone if such discharge causes a film or sheen upon, or discoloration of, the surface of the water, or causes a sludge or emulsion beneath the surface of the water. Violators are subject to a penalty of \$5,000.

BENETEAU

SOLID WASTE DISPOSAL

- Located under the sail locker lid.

Beneteau Part #111356

It is illegal for any vessel to dump plastic trash **anywhere** in the ocean or navigable waters of the United States. Annex V of the MARPOL TREATY is an International

Law for a cleaner, safer marine environment. Violation of these requirements may result in civil penalty up to \$25,000 fine and imprisonment.

3 Miles from Shore

U.S. Lakes, Rivers, Bays and Sounds
ILLEGAL TO DUMP Plastic & Garbage, Paper, Rags, Glass, Food, Metal, Crockery, Dunnage.



3-12 Miles from Shore

ILLEGAL TO DUMP Plastic, Dunnage, lining & packing materials that float, also if not ground to less than one inch; Paper, Rags, Glass, Crockery, Metal, Food.

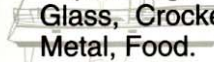

12-25 Miles from Shore

ILLEGAL TO DUMP Plastic, Dunnage, lining & packing materials that float.



Outside 25 Miles

ILLEGAL TO DUMP Plastic



State and local regulations may further restrict the disposal of garbage.

MARINE SANITATION

Your Beneteau is equipped with an USCG approved marine head and holding tank.

By law you must use a holding tank in all U.S. waters, Check with local authorities for regional laws governing your area before selecting the overboard discharge option.

ACCIDENT REPORTING

Knowledge of accident reporting requirements. Please refer to the following list for a copy of the U.S. Coast Guard Boating Accident form. For further information on where to obtain more forms, please call the U.S. Coast Guard Boating Safety Hotline at (800) 368-5647

NATIONAL VESSEL DOCUMENTATION CENTER
2039 STONEWALL JACKSON DR.
FALLING WATERS, WV 25419
TOLL FREE: 1-800-799-8362
PHONE: (304) 271-2400
FAX: (304) 271-2405

RENDERING ASSISTANCE

United States Code, Title 46:

"The owner or operator of a vessel is required by law to render assistance to any individual or vessel in distress, so long as his vessel is not endangered in the process."

IX) COMMISSIONING

COMMISSIONING PROCEDURES

The first commissioning of a yacht is essentially the start of its life, and the importance of proper commissioning procedures at this time cannot be overstated. The first commissioning procedure must be performed by an authorized Beneteau dealer or those authorized by them. The dealer will also have a commissioning checklist to be signed by the owner and a dealer representative at the time of the first commissioning. The owner also needs to concern himself with items such as safety equipment, which is considered to be his responsibility. See the Owner's Operator's Responsibilities section for details.

Lists of the pre-launch and post-launch checks employed during commissioning are provided in this section for those owners interested in understanding the commissioning procedure, as well as for future use in any recommissionings that may be required after periods of wet or dry storage. The lists are of a general nature and do not attempt to provide step-by-step instructions.

The following is a list of minimum commissioning duties. Additional operations may be required dependent upon the model & equipment

PRIOR TO LAUNCH

- _____ All accessories & options supplied per shipping list and boat order
- _____ Check hull and repair any shipping damage - aft end of keel, rudder, etc.
- _____ Prep bottom and apply bottom paint if needed.
- _____ Thru hulls inspected and closed.
- _____ Clean hull thoroughly.
- _____ Check clamps on all thru hulls below waterline.
- _____ Wax hull topsides.
- _____ Dock lines and fenders aboard.
- _____ Check tightness of nuts on prop shaft and zinc. (Folding props require additional steps).
- _____ Check steering system (rudder moving freely stop to stop and does not touch hull?).
(Hydraulic steering requires all fittings be checked and the system is bled)
- _____ Zincs installed.
- _____ Thru hulls unobstructed and speed/log impeller in place (if applicable).
- _____ Fuel valve turned ON.
- _____ Check keel bolts for tightness.

OPERATIONS AFTER LAUNCH

- _____ No water leaks, stuffing box, shaft log, strut, rudder post.
- _____ No leaks at thru hulls; all hose clamps secure with seacocks open.
- _____ Fill water tanks, no leaks at fill pipes, overflows or connections.
- _____ Fill fuel tank.
- _____ Batteries secured, connected, filled and charged. (**NOTE: Beneteau ships batteries dry**)
- _____ Check all cabin lights.
- _____ Check all navigation lights.
- _____ Water pressure system - air bled, no leaks at connections.
- _____ Check electric sump pumps and bilge pump.
- _____ Check manual bilge pump
- _____ Check emergency tiller fit.
- _____ 110V shore power polarity ok and breakers on
- _____ Battery charger ok.
- _____ Hot water heater works-must be filled before turning on.
- _____ Check head(s) operation and holding tank(s) for leaks.
- _____ Test wash down pumps, refrigeration, heaters, etc.
- _____ Test stove and LPG tank for leaks and proper operation
- _____ **DO NOT TEST FOR LEAKS WITH AN OPEN FLAME, WIPE EACH JOINT WITH A SOAPY SOLUTION AND LOOK FOR BUBBLES**

ENGINE START-UP

- _____ Check transmission for proper fluid and proper level.
- _____ Check crankcase dipstick for proper fluid and proper level.
- _____ Check shift and throttle cables for proper adjustment and secure end fittings.
- _____ Engine alarms work when key is on.
- _____ Open engine water intake.
- _____ Start engine, check gauges and water flow at exhaust is normal.
- _____ Check water level in heat exchanger and expansion tank.
- _____ Check belts and mounts.
- _____ Run engine at operating temperature. Note temperature _____ degrees.
- _____ No engine or fuel line leaks-no chafe problems with wires.
- _____ Forward and reverse gears operate.
- _____ After warm-up, shut engine down, check oil, and fluid levels again.
- _____ Alignment to under .003 - coupling bolts tightened.
- _____ Idle set correctly , engine won't stall when put in gear. Idle set at _____ RPM.
- _____ Allow engine to run for at least (1) hour.
- _____ No leaks at the shaft seal.
- _____ Shift and throttle operate smoothly with engine running.
- _____ No leaks at keel bolts after engine run.
- _____ Test run boat, check all operations of shifting, controls etc.
- _____ Maximum RPM in gear _____.

PRIOR TO STEPPING MAST

- _____ Clean or wax spar.
- _____ Mast sheaves free running.
- _____ Run halyards if necessary– Make sure you have clean hands on clean ground.
- _____ Attach and secure all stays and shrouds.
- _____ Attach and secure spreaders to mast and upper shrouds.
- _____ Check boom gooseneck fitting.
- _____ Install mast boot on spar if applicable.
- _____ Check all mast lights.
- _____ Attach and secure boom topping lift.
- _____ Check running lights and electrical connections.
- _____ Protect against chafe on spreader ends and any fitting.
- _____ Check sail track for burrs.
- _____ Turnbuckles attached.
- _____ Re-check all pins, cotters, and Locktite any shackles.
- _____ Check with salesman and work order for additional mast gear.
- _____ Furling system built and connected to mast

AFTER STEPPING MAST

- _____ Protect spar from scratching on mast collar on keel stepped masts.
- _____ Turnbuckles lubricated.
- _____ Attach standing rigging to chain plates.
- _____ Chock mast partner and seal mast boot on keel stepped masts.
- _____ All mast wiring connected.
- _____ Preliminary tune - spar straight - shrouds proper tension.
- _____ Run reefing lines and halyards.
- _____ All cotter pins in place on turnbuckles and opened.
- _____ Run main sheets and attach topping lift.
- _____ Tape chain plates and cotter pins to prevent chafe.
- _____ Check and double-check all turnbuckles, cotter and clevis pins.

PRIOR TO DELIVERY

- _____ Hose test all ports, deck hardware, chain plates, and stanchion posts for leaks.
- _____ Tighten lifelines and tape split rings.
- _____ All doors, drawers, floorboards, hatches, and cabinets operate freely - fit if necessary.
- _____ Clean thoroughly: sinks, bulkheads and counter tops, all lockers and drawers, bilge, cushions, deck and cockpit lockers.
- _____ Dry the bilge completely.
- _____ Clean and oil exterior teak if needed.
- _____ Clean cabin sole, deck area and ports.
- _____ All Coast Guard and safety gear aboard.
- _____ Sails bent on, ALL HEADSAILS (AND MAINSAIL) FIT FURLING. Operate freely.
- _____ All electronics and optional gear tested and working.

DELIVERY TO OWNER

- _____ Walk through the boat with manuals and owner, showing operation of all components.
- _____ Test sail boat with owner showing all operations.
- _____ Fill out warranty certificates.

X) SPECIFICATIONS OF THE BOAT

Type BENETEAU 423
 Name of Builder BENETEAU USA INC.
 Design Category..... A
 No. of acknowledged body..... CE 0607

Length Over All	13.15 m	43.14 ft
Hull Length	12.64 m	41.47 ft
Length Waterline	11.75 m	38.55 ft
Hull Beam	3.94 m	12.93 ft
Draft:	Shoal	1.45 m 4.76 ft
	Medium	1.70 m 5.58 ft
	Deep	2.10m 6.89 ft
Clearance Height	16.57 m	54.36 ft

Maximum Authorized Engine Power :	60 kW	80 hp
-----------------------------------	-------	-------

Fuel Capacity	200 L (52.8 US gal)
Fresh Water Capacity	581 L (153.5 US gal)
Battery Capacity	100A engine 200A house - qty 2

DESIGN CATEGORIES

- Category A: OCEAN – Designed for extended voyages where conditions may exceed wind force 8 (Beaufort scale) and significant wave heights of 4 m and above, and vessels largely self sufficient
- Category B: OFFSHORE – Designed for offshore voyages where conditions up to, and including, wind force 8 and significant wave heights up to, and including, 4 m may be experienced.
- Category C: INSHORE – Designed for voyages in coastal waters, large bays, estuaries, lakes and rivers where conditions up to, and including, wind force 6 and significant wave heights up to, and including, 2 m may be experienced.
- Category D: SHELTERED WATERS – Designed for voyages on small lakes, rivers, and canals where conditions up to, and including, wind force 4 and significant wave heights up to, and including, 0.5 m may be experienced.

Category	Height of the Waves (ft)	Wind Force (Beaufort)
A	> 4 m (13.0 ft)	> 8
B	< 4 m (13.0 ft)	≤ 8
C	< 2 m (6.5 ft)	≤ 6
D	< .5 m (1.6 ft)	≤ 4

For additional information concerning the standard equipment, please refer to the manuals enclosed with the boat.

Maximum recommended number of persons on board by design category:

Category	Maximum Number of Persons
A	10
B	11
C	12
D	12

The C.E. Certified equipment includes: The fuel tanks, parts of the steering system, parts of the gas system and the hatches and portholes.

WEIGHT ESTIMATION

SAILING CATEGORIES	A	B	C	D
	Kg (lbs)	Kg (lbs)	Kg (lbs)	Kg (lbs)
Light Displacement :	8845 (19,500)	8845 (19,500)	8845 (19,500)	8845 (19,500)
Includes:				
Light Boat + Safety Equipment + Sails				
Life Raft :	75 (165)	75 (165)	75 (165)	75 (165)
Crew :	750 (1,653)	900 (1,944)	900 (1,944)	900 (1,944)
Water :	550 (1,213)	550 (1,213)	550 (1,213)	550 (1,213)
Fuel :	160 (353)	160 (353)	160 (353)	160 (353)
Personal Equipment :	220 (485)	220 (485)	220 (485)	220 (485)
Optional Equipment				
Holding Tank :	200 (441)	200 (441)	200 (441)	200 (441)
Air Conditioning :	80 (176)	80 (176)	80 (176)	80 (176)
Teak Deck	140 (309)	140 (309)	140 (309)	140 (309)
Extra Battery :	35 (77)	35 (77)	35 (77)	35 (77)
Auto Pilot Gear :	25 (55)	25 (55)	25 (55)	25 (55)
Mech. Refrigeration	25 (55)	25 (55)	25 (55)	25 (55)
Bow Thruster	40 (88)	40 (88)	40 (88)	40 (88)
Spinnaker Pole :	10 (22)	10 (22)	10 (22)	10 (22)
Microwave Oven :	15 (33)	15 (33)	15 (33)	15 (33)
Roof Sprayhood / Bimini :	35 (77)	35 (77)	35 (77)	35 (77)
Davits :	40 (88)	40 (88)	40 (88)	40 (88)
SUB TOTAL (Optional Equipment)	645 (1,422)	645 (1,422)	645 (1,422)	645 (1,422)
Margin for Other Equipment	360 (793)	360 (793)	360 (793)	360 (793)

MAXIMUM LOAD DISPLACEMENT Kg (Lbs.)	11,605 (25,584)	11,605 (25,584)	11,605 (25,584)	11,605 (25,584)
--	------------------------	------------------------	------------------------	------------------------

MAXIMUM LOAD Kg (Lbs.)	2760 (6,084)	2760 (6,084)	2760 (6,084)	2760 (6,084)
-----------------------------------	---------------------	---------------------	---------------------	---------------------

MAXIMUM LOAD = MAXIMUM LOAD DISPLACEMENT – LIGHT BOAT

ANY OVERLOADING CARRIES A RISK OF FLOODING OR LOSS OF STABILITY

XI) INTERIOR LAYOUT

2 CABIN / 2 TOILET

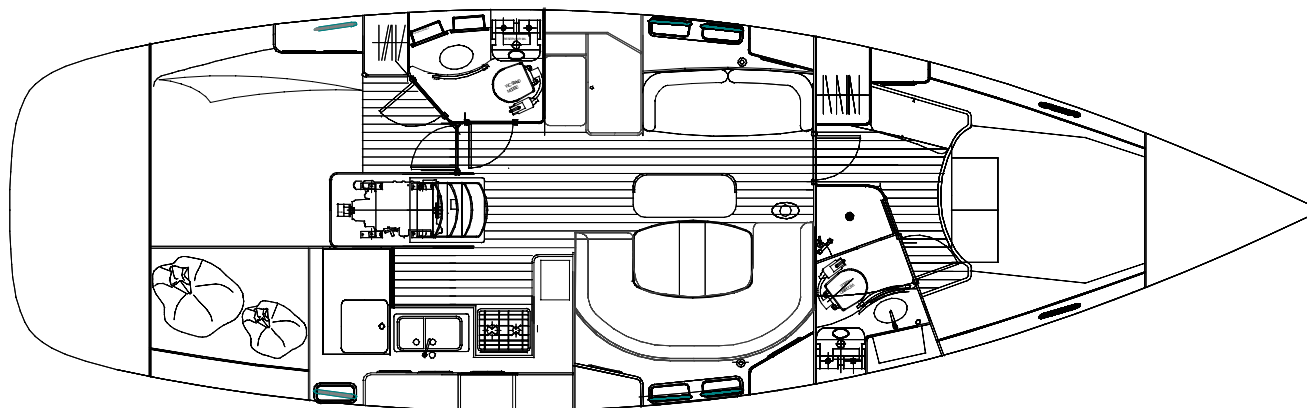

3 CABIN / 2 TOILET

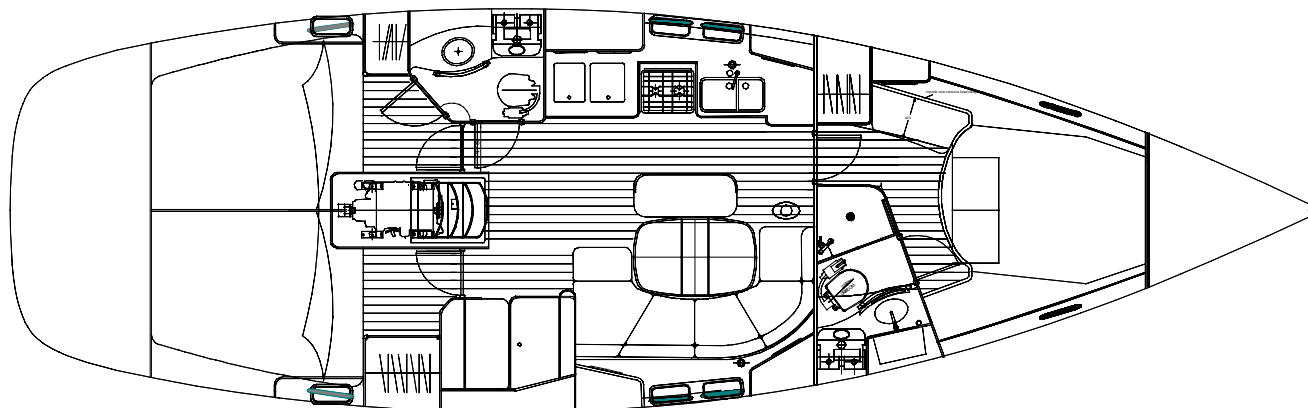

EXIT IN CASE OF FIRE

 = Emergency Exit

 = Recommended Fire Extinguisher Location

2 CABIN / 2 TOILET

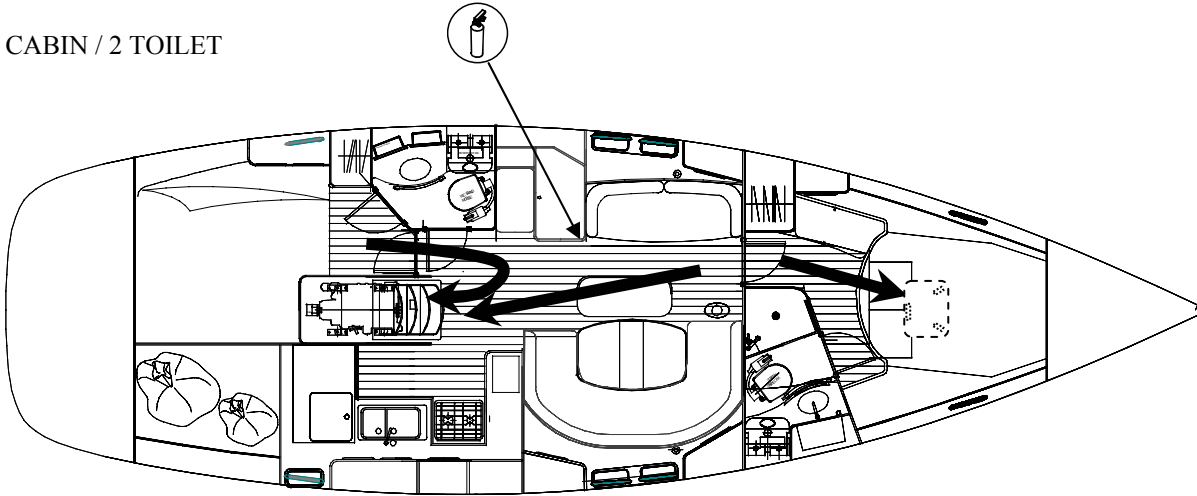

3 CABIN / 2 TOILET

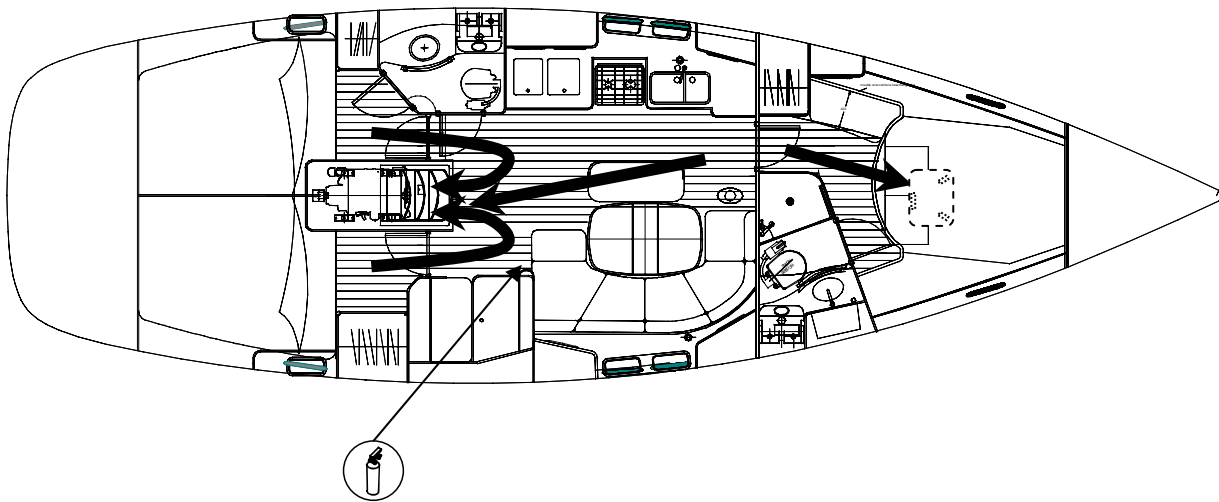

XII) DECK

- Jack lines can be fastened either to the mooring cleats, or to pad eyes on deck.

The Beneteau 423 is fitted with a foldaway swimming ladder. The swimming ladder should be in its folded/upright position as soon as you are on board.

Make sure that the hatches and portholes are closed before you put out to sea.

In case of rough sea, close the boat with the sliding hatch and weatherboards so that no water may come into the boat.

Check that nothing blocks up the cockpit drain holes; these holes should never be sealed.

- 1 Recommended location of the life-raft
- 2 Fwd water tank deck fill
- 3 Fwd waste tank pump out deck plate
- 4 Aft water tank deck fill
- 5 Aft waste tank pump out deck plate
- 6 Fuel deck fill
- 7 Swim ladder



Recommended Fire Extinguisher Location

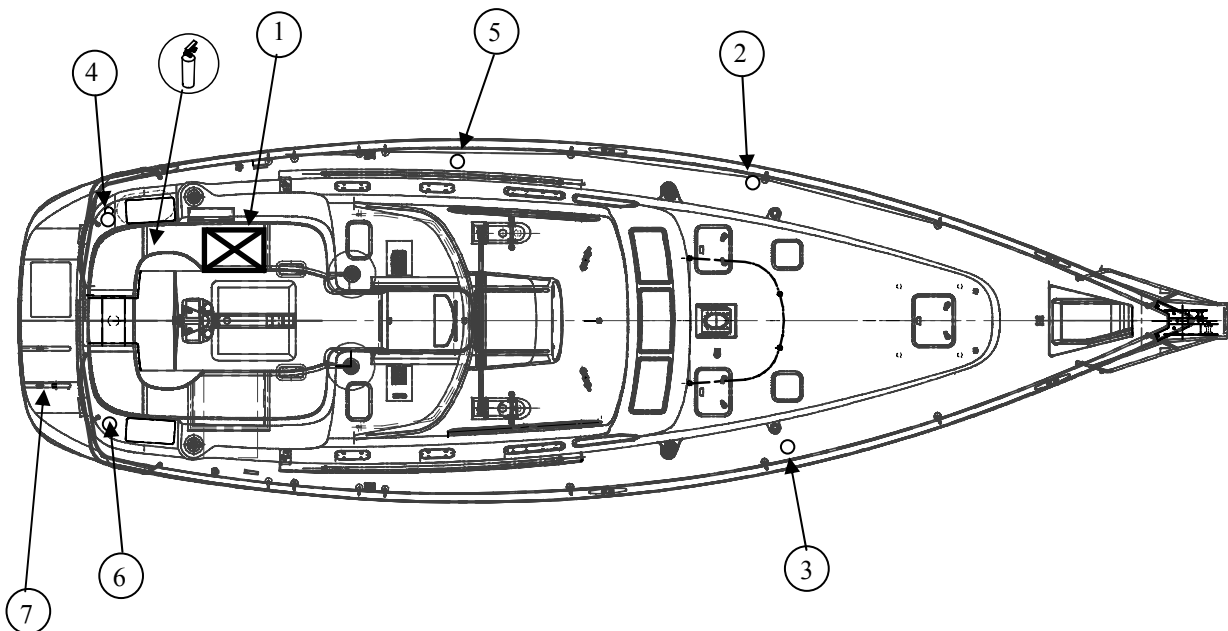

XIII) SAILS AND RIGGING

Specifications of the Sails:

SAIL	AREA	
	Roller furling main	Classic main
Total	81.5 m ²	86.0 m ²
Mainsail	29.6 m ²	34.1 m ²
Genoa (140%)	51.9 m ²	51.9 m ²

Roller furling mast			Classic mast		
I	14.83	m	I	14.83	m
J	5.035	m	J	5.035	m
P	13.08	m	P	13.24	m
E	4.52	m	E	4.52	m

Specifications of the Standing Rigging:

V: VERTICAL - D: DIAGONAL

REF	CABLE	Dia. In.
1	V1 (Shroud)	3/8
2	D1 AFT (Aft Lower Shroud)	3/8
3	D1 FWD (Fwd Lower Shroud)	9/32
4	V2D3 (Upper Shroud)	5/16
5	D2 (Inter)	5/16
6	Forestay	3/8
7	Backstay	9/32

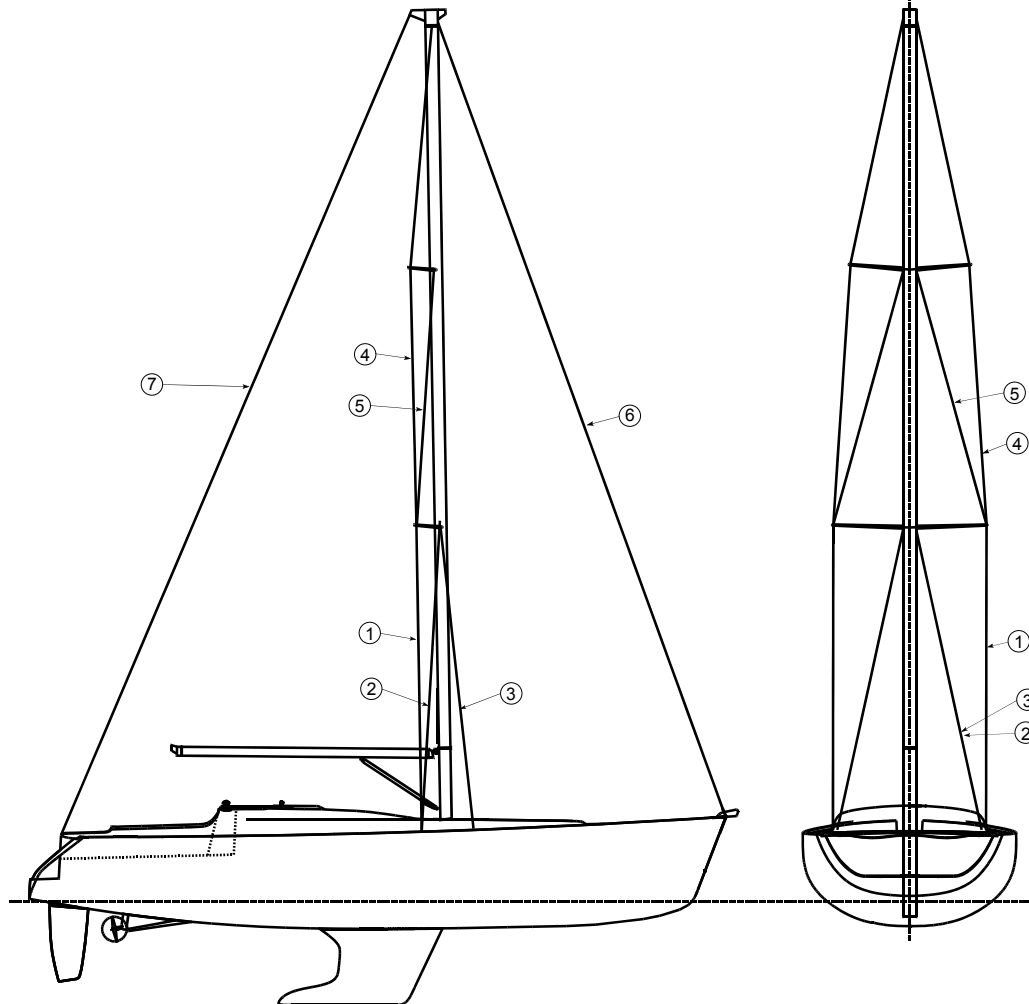
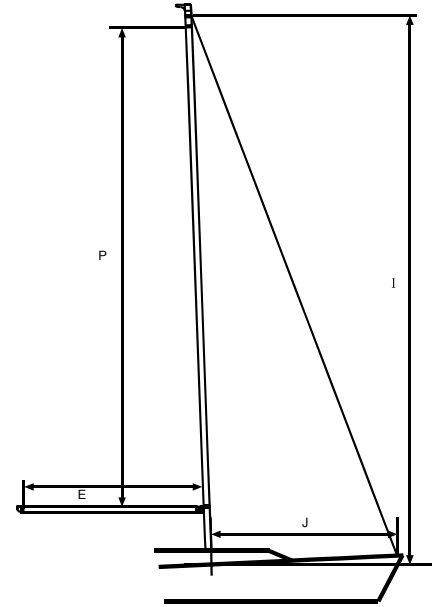

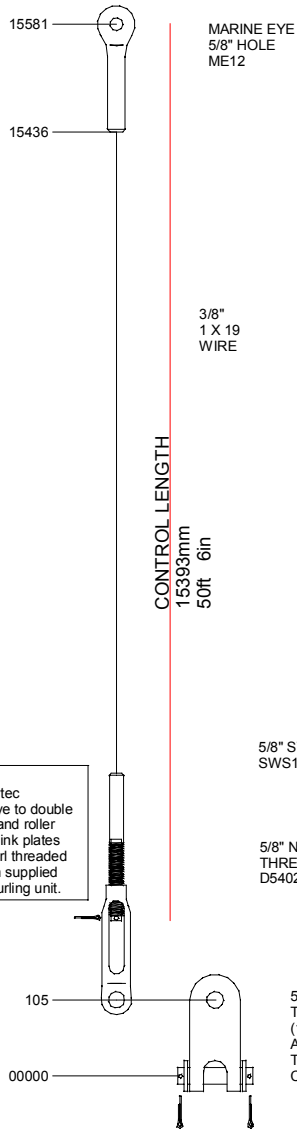

CONTROL LENGTH
15393mm
50ft 6in

NOTE:
Fasten Navtec
threaded eye to double
jaw toggle and roller
furling unit link plates
using Profurl threaded
stepped pin supplied
with roller furling unit.

FORESTAY

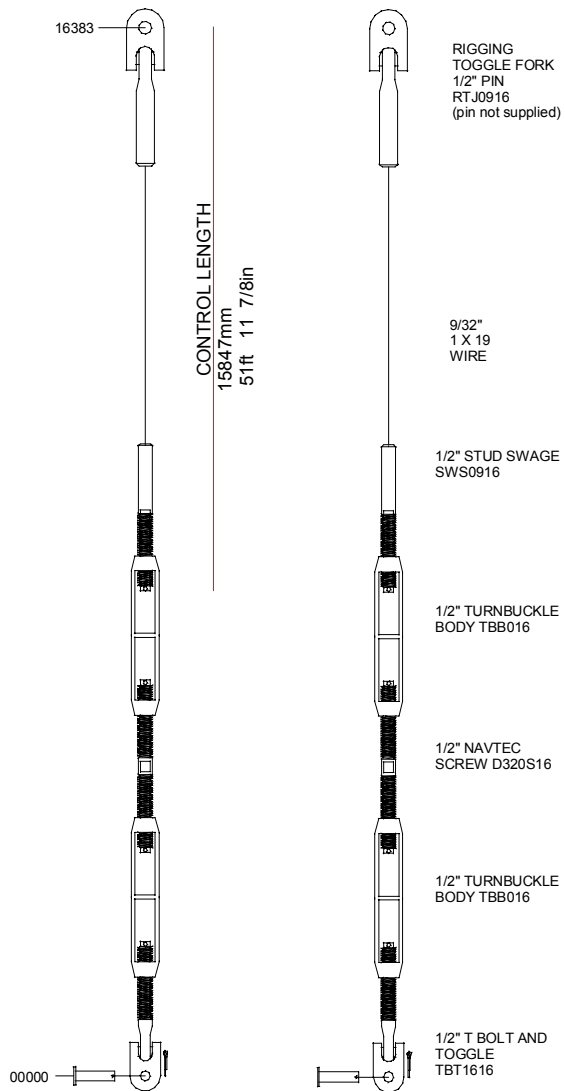

CONTROL LENGTH
15847mm
51ft 11 7/8in

BACKSTAY

NOTE:
ALL MEASUREMENTS TAKEN WITH TURNBUCKLES 2/3 OPEN

Material :		Dimension in mm :		Visa :	
<p style="text-align: center;"><u>CAUTION</u> <u>CAD</u> <u>DRAWING</u></p>		Scale:		Gen.Tol.:	
		STANDING RIGGING KIT BOX 1/2 O423			
01	Backstay +40mm hull 19 on	BdB	02/04/03	Design Date : 09/03/02 By : BDB	
R	DESCRIPTION	By	DATE	Approved Date : By :	
BENETEAU USA INC. 1313 HIGHWAY 76 WEST PO DRAWER 1218 , MARION, SC 29571 Tel. (843) 423-4201 - Fax. (843) 423-4912				Weight : N^o 12257	
				01	
THIS DOCUMENT IS - PROPRIETARY AND REPRODUCTIONS MUST BE AUTHORIZED BY BENETEAU - DRAWN BY BENETEAU - SPECIFIED AND DESIGNED BY PRODUCT MANUFACTURER.					

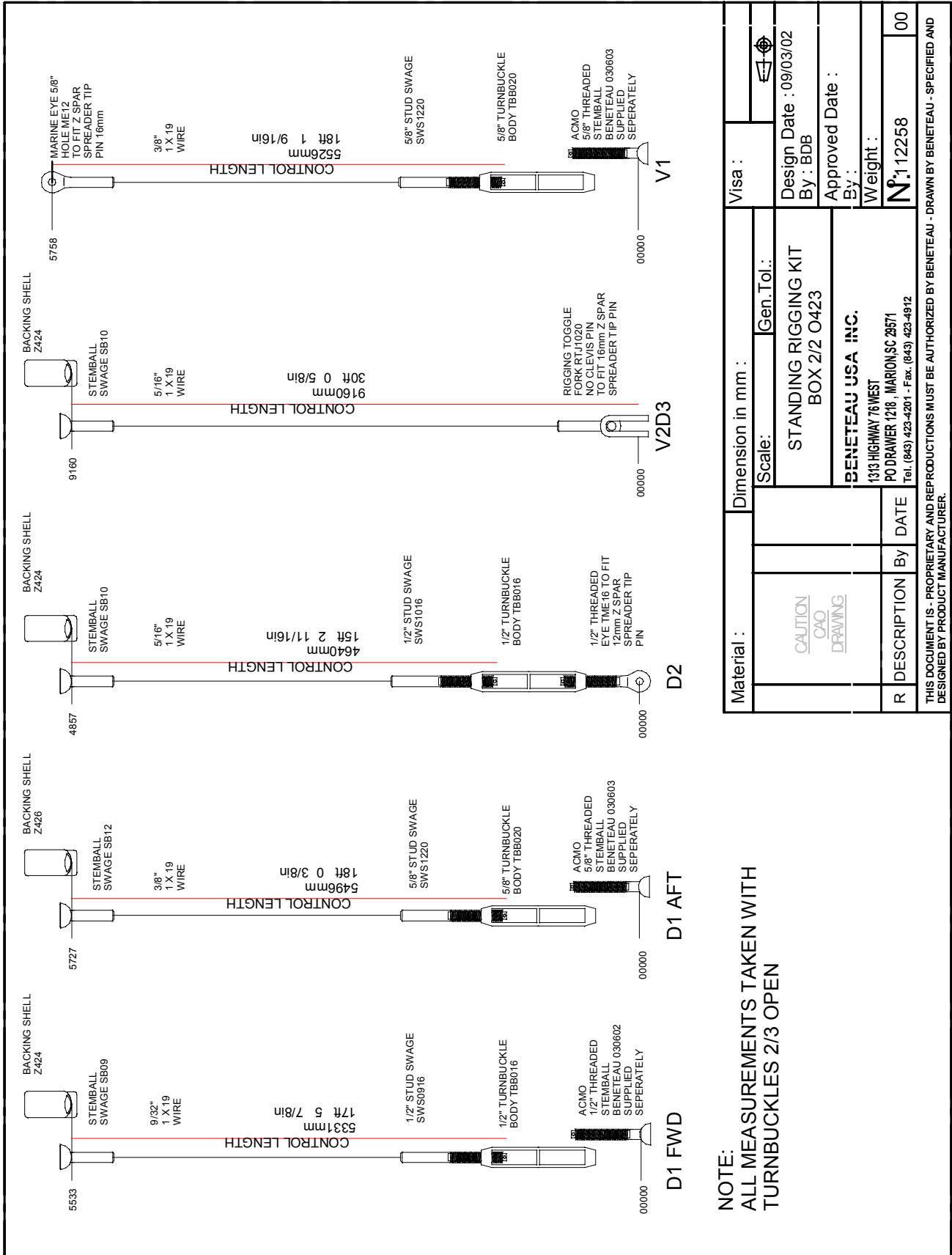

NOTE:
 ALL MEASUREMENTS TAKEN WITH
 TURNBUCKLES 2/3 OPEN

Material :	Dimension in mm :	Scale :	Gen.Tol.:	Visa :
CAUTION CAO DRAWING		STANDING RIGGING KIT BOX 2/2 O423		
		BENETEAU USA INC. 1313 HIGHWAY 76 WEST PO DRAWER 1218, MARION SC 29571 Tel. (843) 423-4201 - Fax. (843) 423-4912		
R	DESCRIPTION	By	DATE	Approved Date :
				By :
				Weight :
				N ^o : 12258
				00

THIS DOCUMENT IS - PROPRIETARY AND REPRODUCTIONS MUST BE AUTHORIZED BY BENETEAU - DRAWN BY BENETEAU - SPECIFIED AND DESIGNED BY PRODUCT MANUFACTURER.

MAKE	PROFURL
MODEL	B35M
NUMBER OF EXTRUSIONS	7 X 2M & 1 X 0730
FORESTAY DIAMETER	3/8" 1X19 SS CABLE

PLASTIC MULTI TOP
HALYARD RESTRAINER CAP

HALYARD SWIVEL WITH
HALYARD SHACKLE
8mm BOW

INTEGRAL FEEDER

NO PREFEEDER

ADJUSTABLE TACK SHACKLE
ON TURNBUCKLE CYLINDER
8mm BOW SHACKLE

30M X 10mm DACRON LINE:
(99' X 3/8")

STAINLESS STEEL
DRUM GUARD

PLASTIC SPLIT
DRUM

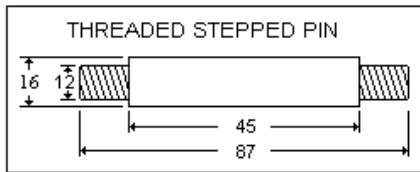

ABOVE THREADED STEPPED PIN
ATTACHES THREADED EYE TO THE
DOUBLE JAW TOGGLE AND PROFURL
LINK PLATES
DOUBLE JAW TOGGLE SUPPLIED
SEPERATLY

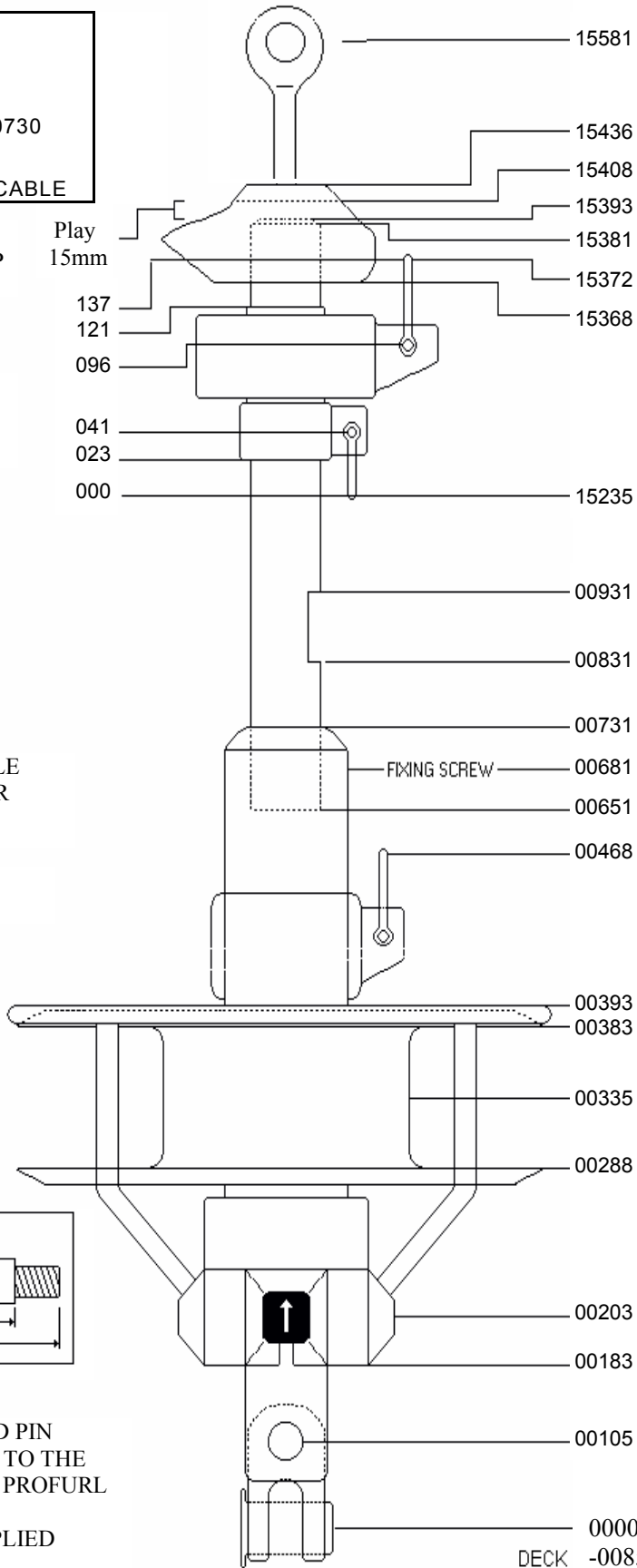

9/04/2002	BY: MSR	ALSO SHOWN:	112266 EXTRUS	PART NUMBER	112265
PROFURL BASIC GENOA RF SYSTEM O423					
11/15/02	11/27/02				
PROTOTYPE	FURLING LINE				
0	Forstay +36mm				
1					

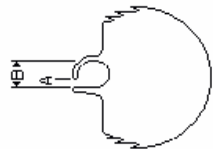

DIMENSION mm	A	B
LUFF GROVE	2.6	5.8

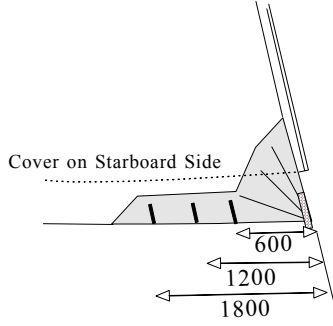
Headsail Specification and Technical Worksheet					
Model Type:		<i>Beneteau Oceanis 423 USA</i>			
Sail Type:		<i>Roller Furling Genoa</i>			
"I" Dim:	<i>14830</i>	"J" Dim:	<i>5035</i>	Max Hoist:	<i>14731</i>
				Area:	<i>50.00sqmt</i>
Finished Dimensions					
Luff:	<i>14500</i>	Leech:	<i>13690</i>	Foot:	<i>7500</i>
		L.P.:	<i>7049 / 140%</i>		
Finish Details					
Material Type:	<i>8.03 Challenge</i>		Tack Detail:	<i>Double webbing Loop</i>	
Head Detail:	<i>Double Webbing Loop</i>		Clew Detail:	<i>50mm ext ring with Leather</i>	
Foam Luff:	<i>Multi track foam luff system</i>		Trim Stripe	<i>2 sets, 2 x 3/8" Black</i>	
Tell Tale:	<i>Yes, 3 sets</i>		T-tale Window:	<i>12" round</i>	
Leech/foot:	<i>25 mm single fold tabling</i>		Foil Tape:	<i>NP#5</i>	
Leech Cleat:	<i>241 Alum. Cleat with snubbing eyes</i>		Foot Cleat:	<i>2 #3 eyelets at tack</i>	
Leech Lines:	<i>Foot and Leech/4mm Dacron</i>		Seam:	<i>V-92 blue 2-3step</i>	
Bag Type:	<i>Drawstring type "C"</i>				
U.V. Cover:	<i>Yes, Starboard</i>		Cover Material/Colour:	<i>White U.V. Mark Cloth</i>	
Furling System:	<i>Profurl B35M / Ben Part number: 112265</i>				
Drawing Information					
Drawn By:	<i>BP</i>	Date:	<i>9-9-02</i>	Rev #:	<i>0</i>
				112269-R000- RF Genoa.doc	
Additional Notes:	<i>1ST PRODUCTION SAIL</i>				
Tack/Reefing Detail:					
					

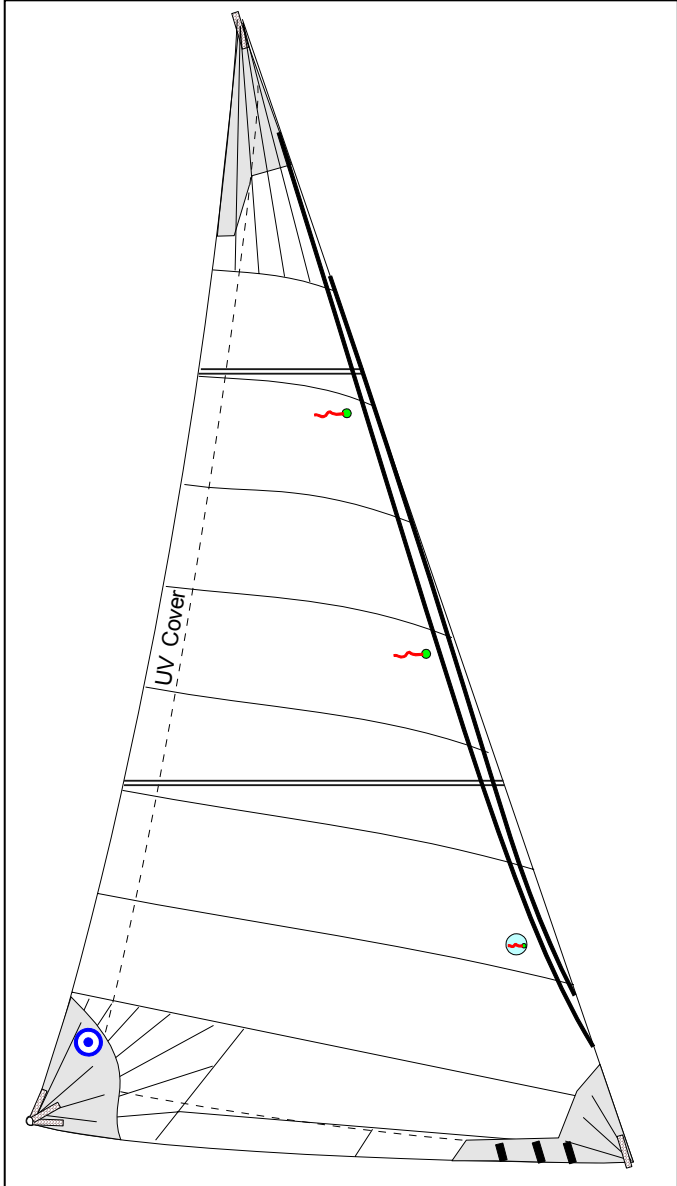

Mainsail Specification and Technical Worksheet							
Model Type:		Beneteau Oceanis 423 U.S.A.					
Sail Type:		Roller Furling Mainsail					
"P" Dim:	13080	"E" Dim:	4520	Area:	27.20sqmt		
Finished Dimensions							
Luff:	12930	Leech:	13176	Foot:	4492		
Finish Details							
Material Type:	8.9/9.3 Challenge/Contender		Clew Slug/Car:	Z-spar 3259 Clew block			
Head Detail:	Single ply 25mm webbing loop Loop extends 50mm		Tack Detail:	Single ply 25mm webbing loop Loop extends 50mm			
Clew Detail:	Pg 38 safety clew ring with webbing		Insignia:	Yes, black			
			Seams:	2 rows 3step, Blue V-92			
Draft Stripe:	Yes, 2x3/8" black		Tell Tale:	Yes 2 leech tell tails			
Leech Cleat:	241 Alum cleat with snubbing eyes		Bag Type:	Drawstring type "C"			
Luff Rope	NPS#6 Foil Tape. Luff tape ends at the foot/luff intersection.		Cover Material/Colour:	Clew only, both sides: UV cloth / white			
Mast Section:	Z-Spar: Z600E		Boom Section	Z-spar: Z480e			
Tack and Clew Cutback Details:							
A:	50mm	B:	100	C:	500	Note: These are for design reference only; sail does not have cut back or cut out at foil tape.	
Drawing Information							
Drawing Name:	423-rfm	Drawn By:	Bob	Date:	11-20-00	Revision #	112267-r000-RF Mainsail.doc
Additional Notes:	Finished Dimensions include head and tack webbing.						

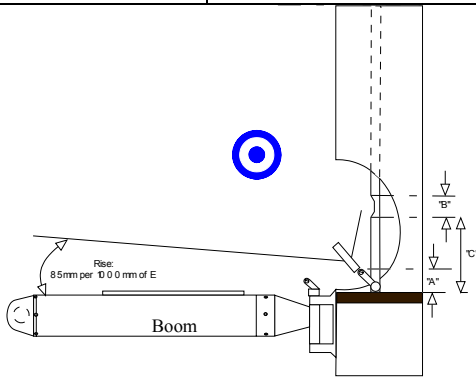

Tack/Clew Detail

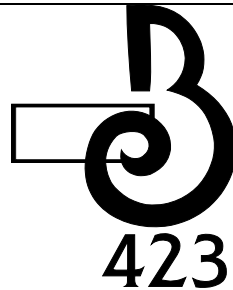

Black Insignia

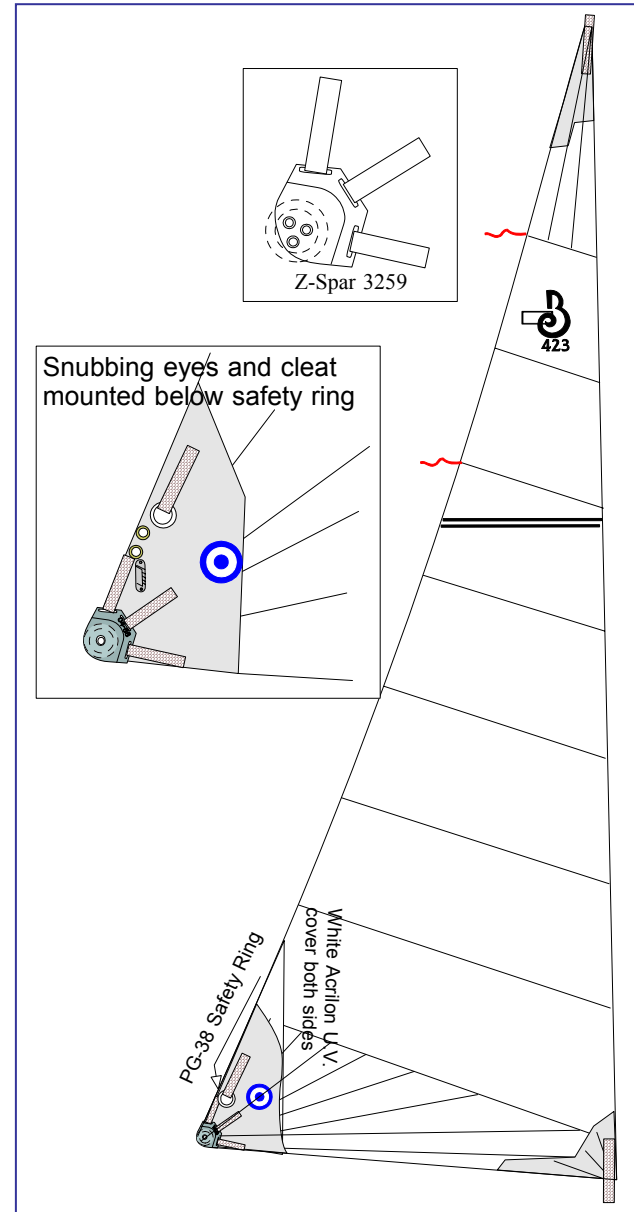

Mainsail Specification and Technical Worksheet

Model Type:	Beneteau Oceanis 423												
Sail Type:	Fully Battened Mainsail												
"P" Dim:	13240	"E" Dim:	4520	Rake:	301	Area:	33.20sqmt						
Finished Dimensions													
Luff:	13110	Leech:	13663	Foot:	4457								
Finish Details													
Material Type:	9.3 & 9.1 Challenge			Tack Detail:	40mm SS Ring with leather								
Head Detail:	50mm ext. ring with bar Leather			Clew Slug/Car:	SLD151 (B102) Cast Slug								
Head Slide:	SLD 685 / B012 below ring			Clew Reefs:	3259 z-spar rf clew block Dia: 60mm on starboard side.								
Clew Detail:	50mm SS ring with leather			Tack Reefs:	3259-w/1246 z-spar Dia: 35mm on starboard side.								
Seams	V-92 blue. 2 rows -3step			Insignia:	Yes, black								
Battens:	4 x 40mm flat full length												
Bat. Lengths:	#1	1152	#2	2139	#3	3078	#4	3810	#5	na			
Bat fittings:	A303 with A114 Selden Allslips			Tell Tale:	1 at each batten								
Leech Cleat:	241 Alum. With snubbing eyes			Foot Tape:	25mm single tabling								
Luff Tape:	5" with 8mm rope			Trim stripe	2x3/8" black								
Leech Line:	4mm Dacron line			Sail Ties:	Yes, 3 x 2.4M ties								
Reef Cleat:	241 Alum.			Bag Type:	Drawstring type "D"								
Reef Hts. % of P	Reef 1	15%	Reef 2	35%	Reef 3	na							
Luff Slides:	1 between each batten: A014 Selden			Reef eyes:	7 # 3 eyelets								
Ditty Bag:	With Genoa			Neil Pryde logos	2 bullseyes								
Mast:	Z-601			Boom:	Z-480								
Tack and Clew Cutback Details:													
A:	50	B:	000	C:	350	D:	000	E:	20	F:	280	G:	65
Drawing Information													
Drw Name:	423-clm.doc			Drawn By:	Bob	Date:	Oct-02	Rev#	112268-R000-CLMain.doc				
Additional Notes:	Tack and Clew offsets measured from slides.												

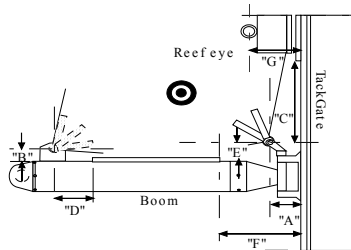

Cutback details

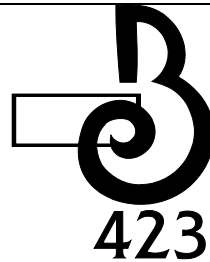

Insignia Detail

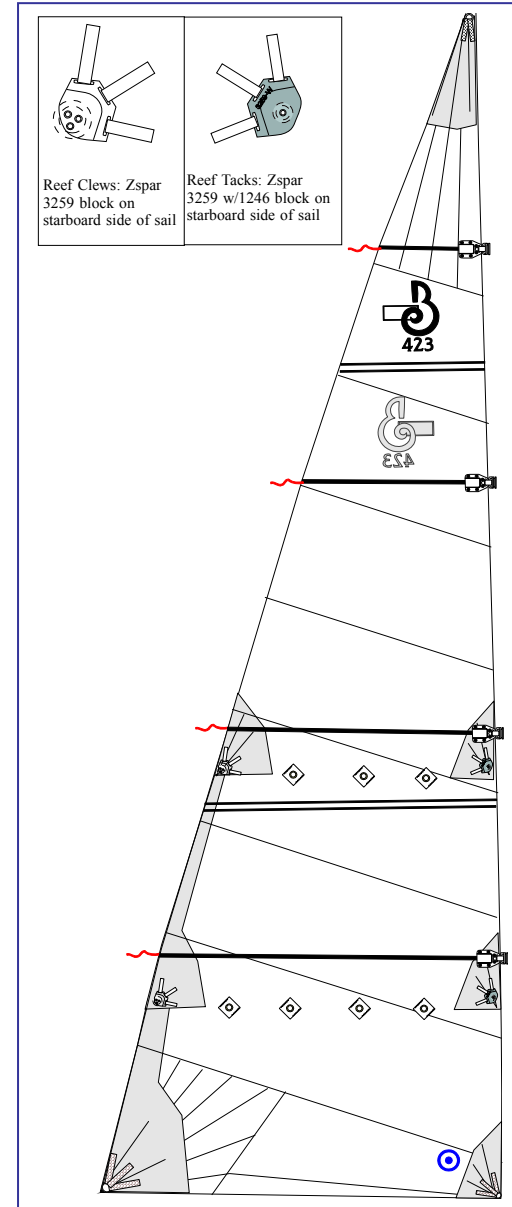

Beneteau 423 Classic Lazy Bag

Notes:

Cover: Forest Green Sunbrella

- 1 Top section folded over to accept a 1mm round batten
2. Top sewn to seam. See detail
3. Openings for line notched in as shown.
4. Front flap to fold inside bag while sailing and Velcro to the interior of bag.
5. Web loops and buckle at fore and aft ends for tensioning. **these should be sewn on the inside of the bag
6. Back of batten 'pocket' sewn closed.
7. Front needs to have internal velcro closure to keep batten in place.
8. One half of the top with extra tabling width to provide for zipper 'flap'.
9. One Bullseye on each side of bag
10. 2 number 2 eyelets on both sides of rear of bag for tensioning purposes
11. 1 number 2 eyelet on each side at front top of bag

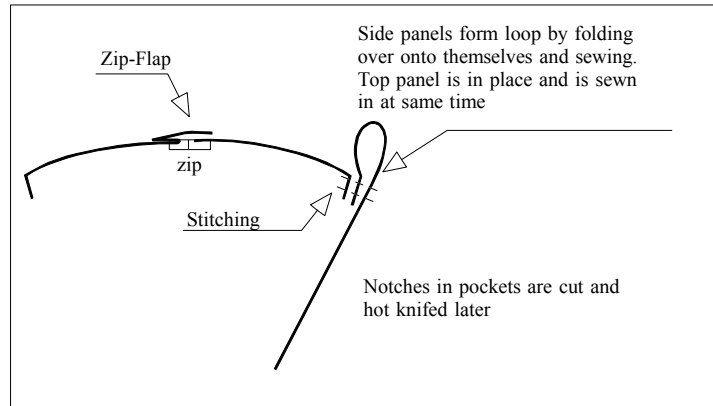

Zipper half to both sides and sewn to front
Fore/aft zipper to pull FORWARD from aft end.

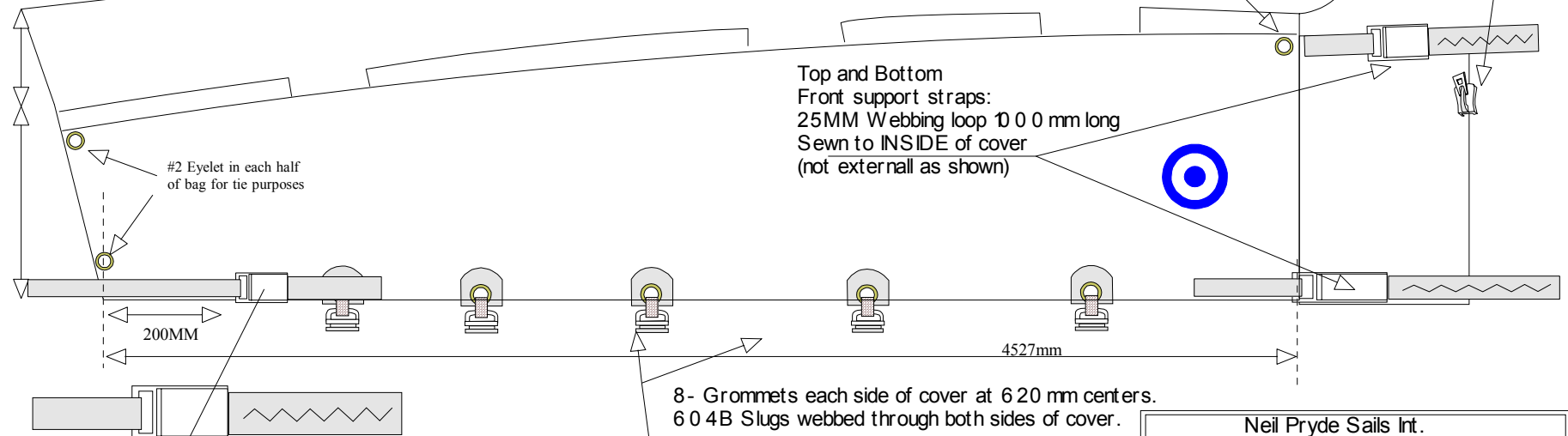

Buckle and loop 25mm x 500 mm
Loop goes through corner rings and back to other side of bag to allow for tensioning.

Note: Buckle to be set inside rear covers by 200 mm

Neil Pryde Sails Int.			
354 Woodmont Rd #18 Milford Conn. 06460 U.S.A. Phone: 203-874-6984 Fax: 203-877-7014			
Drawing Name: 423 Lazy Bag			
Date:	Sept 2002	Scale:	Not to Scale
Drawn by:	Bob Pattison	Rev:	000
Copyright 2002 Neil Pryde Sails			

423 Lazy Jacklines

Finalized lengths: Nov-02
 Material List for BOTH SIDES
 4- 30mm rings
 33mts of 5mm line
 Lines will be tied around round batten
 stock that is exposed in cutouts

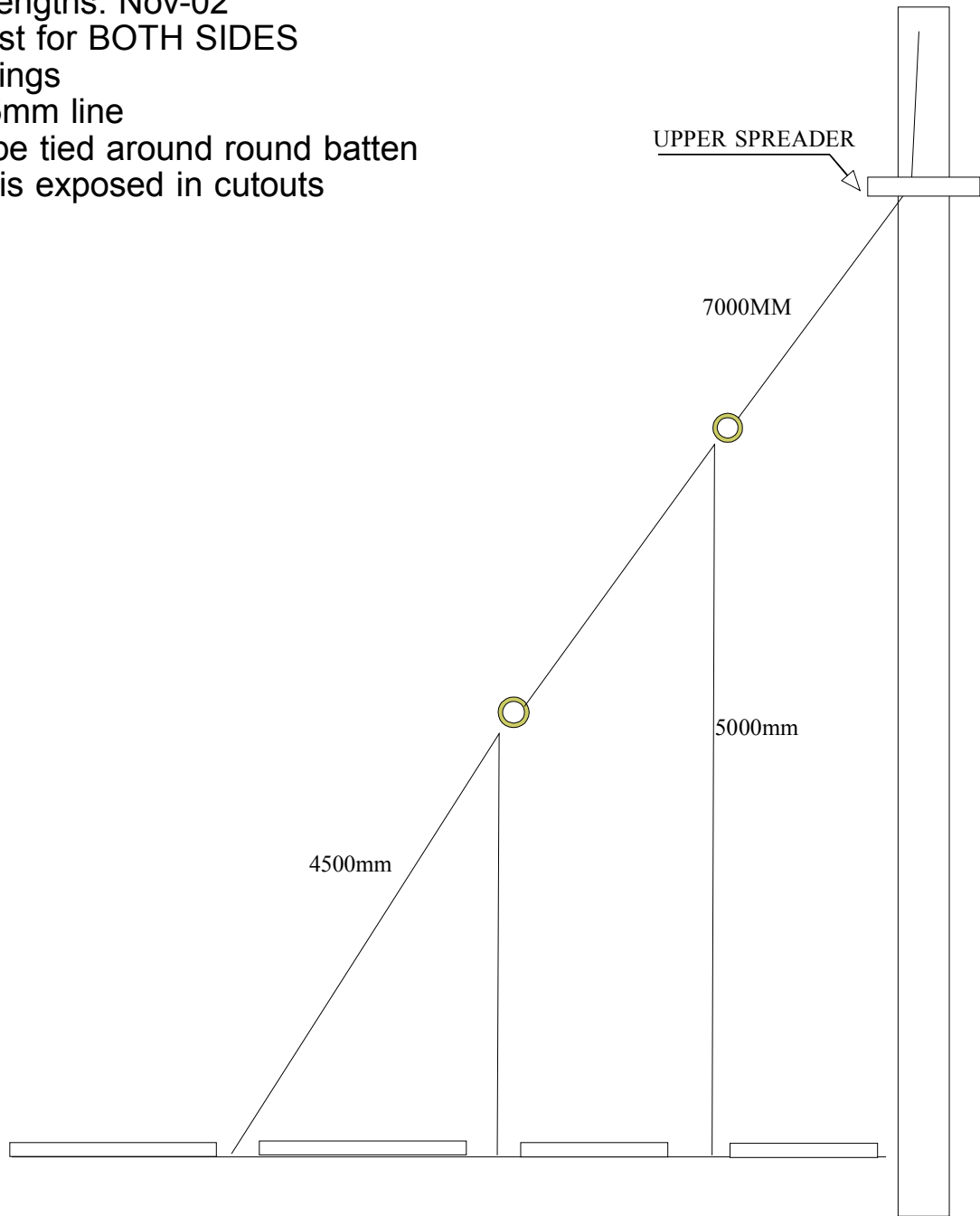

NEIL PRYDE DESIGN OFFICE	
354 Woodmont Rd. B, Milford CT 06460 USA.	
Tel: 203-874-6984 Fax: 203-877-7011 email: admin@neilprydesails.com	
Drawing Name:	423 jack lines
Date:	Nov-02 Scale: Not to Scale
COPYRIGHT 2002 NEIL PRYDE SAILS INT.	

DECK LAYOUT FOR ROLLER FURLING MAST (STANDARD) + OPTIONAL GENNEKER

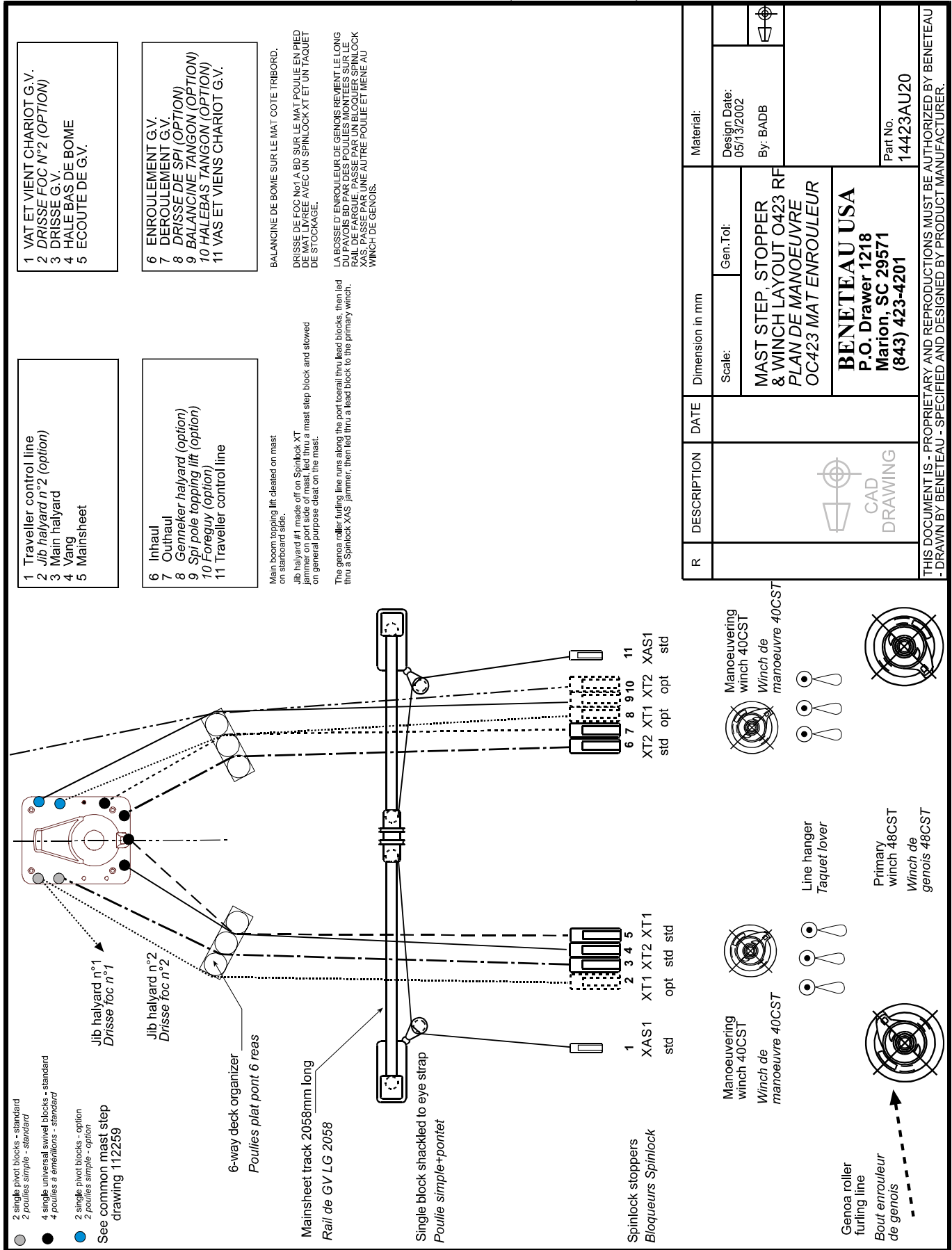

- 1 VAT ET VIENT CHARIOT G.V.
- 2 DRISSE FOC N°2 (OPTION)
- 3 DRISSE G.V.
- 4 HALE BAS DE BOME
- 5 ECOUTE DE G.V.

- 1 Traveller control line
- 2 Jib halyard n°2 (option)
- 3 Main halyard
- 4 Vang
- 5 Mainsheet

- 6 ENROULEMENT G.V.
- 7 DEROULEMENT G.V.
- 8 DRISSE DE SPI (OPTION)
- 9 BALANCINE TANGON (OPTION)
- 10 HALEBAS TANGON (OPTION)
- 11 VAS ET VIENS CHARIOT G.V.

- 6 Inhaul
- 7 Outhaul
- 8 Genneker halyard (option)
- 9 Spi pole topping lift (option)
- 10 Foreguy (option)
- 11 Traveller control line

BALANCINE DE BOME SUR LE MAT COTE TRIBORD,
 DRISSE DE FOC N°1 A BD SUR LE MAT POULIE EN PIED
 DE MAT LIVREE AVEC UN SPINLOCK XT ET UN TAQUET
 DE STOCKAGE.
 LA BOSSE D'ENROULEUR DE GENOIS REVENTLE LONG
 DU PAYS BD ET LA BOSSE D'ENROULEUR DE SPI
 XAS, PASSE PAR UNE AUTRE POULIE ET MENE AU
 WINCH DE GENOIS.
 Main boom topping lift cleated on mast
 on starboard side.
 Jib halyard #1 made off on Spinlock XT
 jammer on port side of mast, led thru a mast step block and stowed
 on general purpose cleat on the mast.
 The genoa roller-furling line runs along the port boreal thru lead blocks, then led
 thru a Spinlock XAS jammer, then led thru a lead block to the primary winch.

R	DESCRIPTION	DATE	Dimension in mm	Material:
	 CAD DRAWING		Scale:	Design Date: 05/13/2002
			Gen. Tol:	By: BADB
	MAST STEP STOPPER & WINCH LAYOUT 0423 RF PLAN DE MANOEUVRE OC423 MAT ENROULEUR			
	BENETEAU USA P.O. Drawer 1218 Marion, SC 29571 (843) 423-4201			Part No. 14423AU20

THIS DOCUMENT IS - PROPRIETARY AND REPRODUCTIONS MUST BE AUTHORIZED BY BENETEAU
 - DRAWN BY BENETEAU - SPECIFIED AND DESIGNED BY PRODUCT MANUFACTURER.

DECK LAYOUT FOR CLASSIC MAST (OPTION) + OPTIONAL GENNEKER

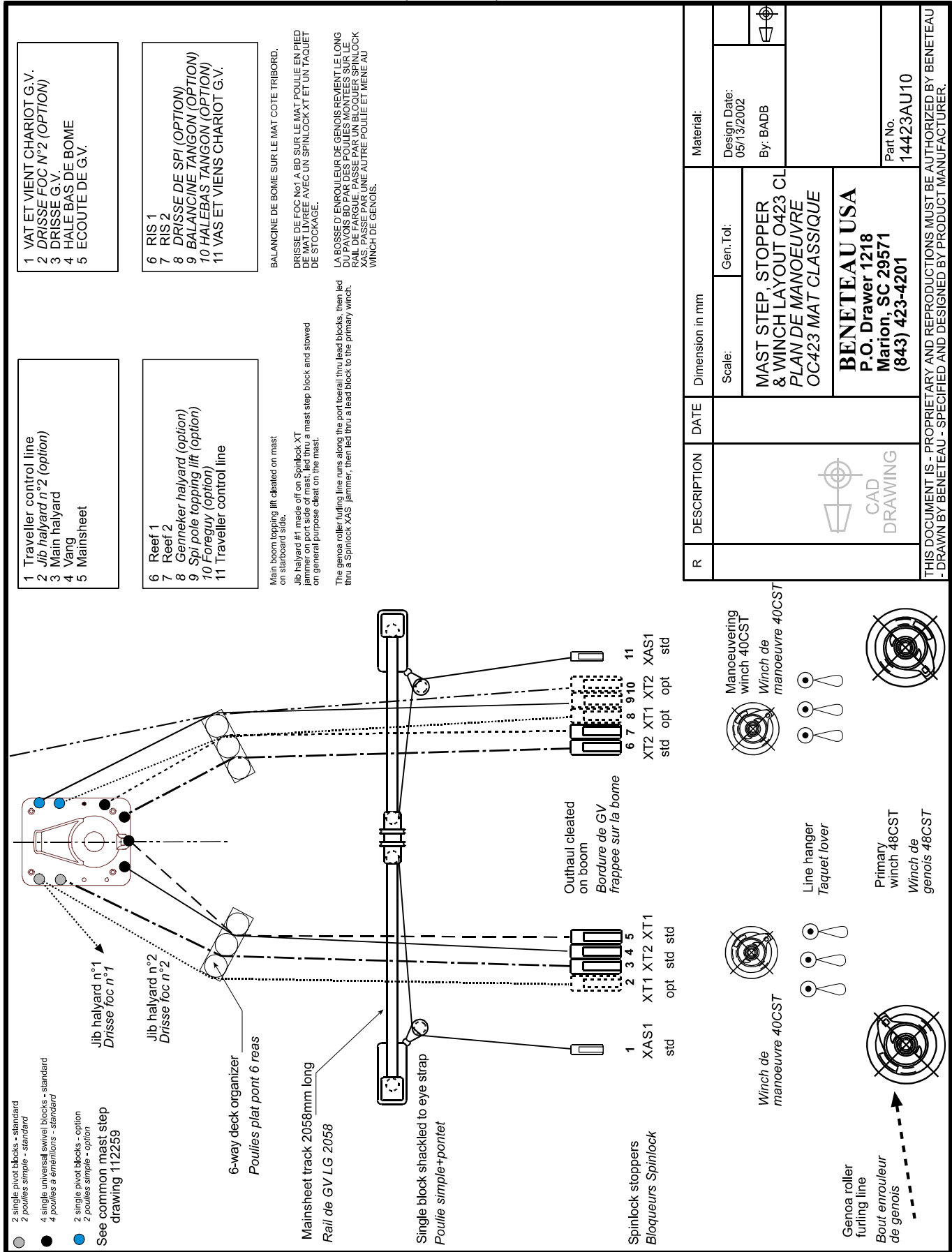

THIS DOCUMENT IS - PROPRIETARY AND REPRODUCTIONS MUST BE AUTHORIZED BY BENETEAU - DRAWN BY BENETEAU - SPECIFIED AND DESIGNED BY PRODUCT MANUFACTURER.

MAINSHEET LAYOUT FOR ROLLER FURLING MAST (STANDARD)

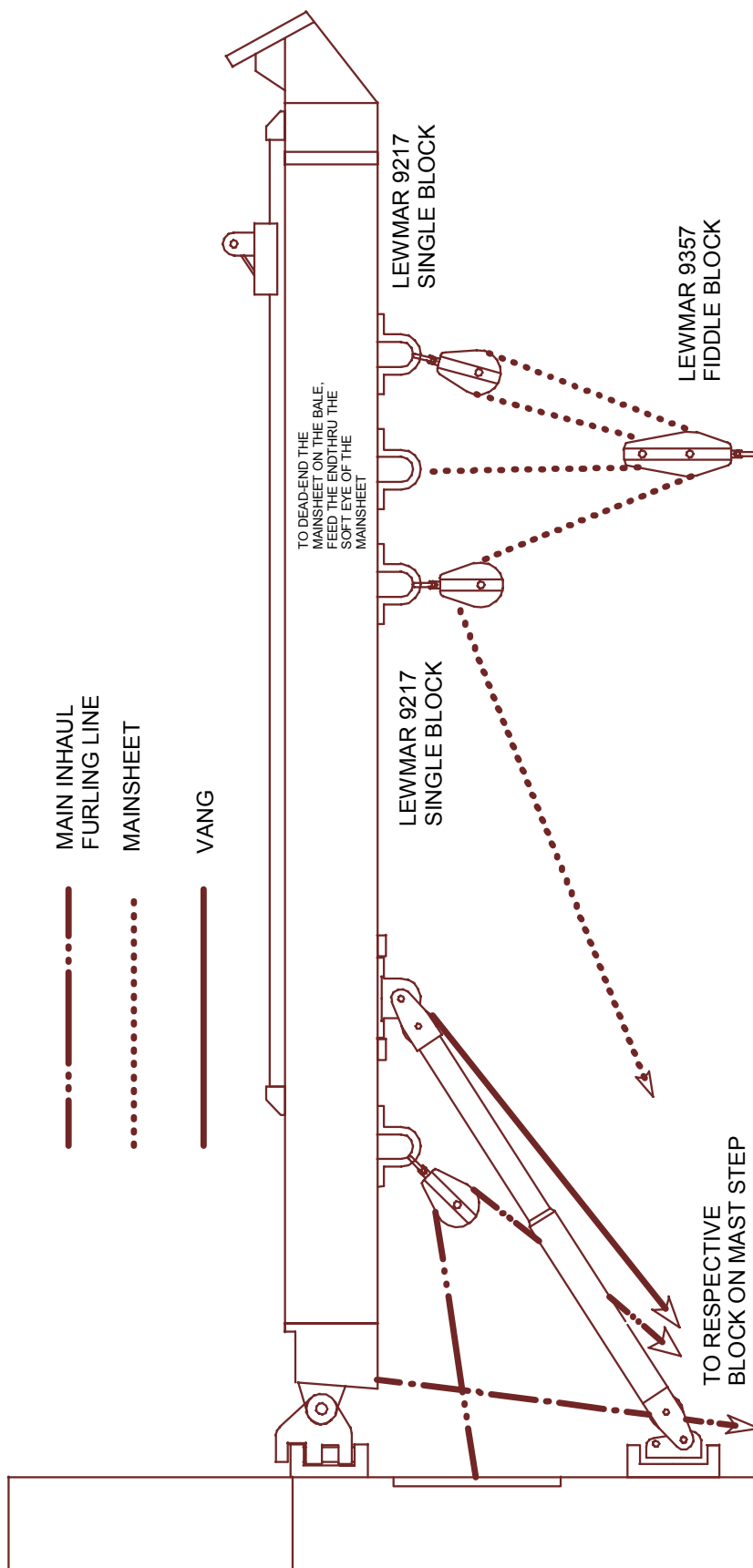

MAINSHEET LAYOUT FOR CLASSIC MAST

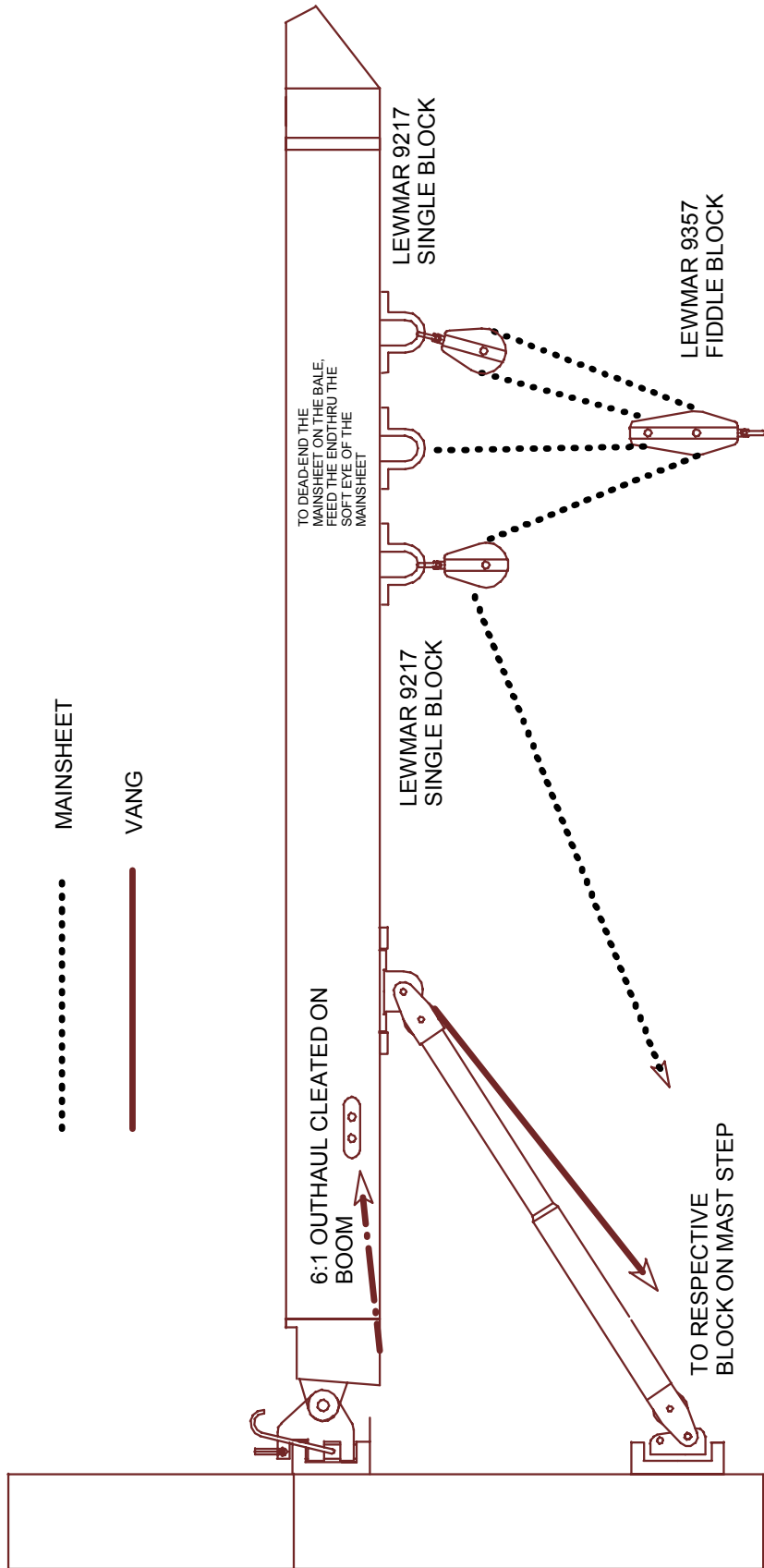

RUNNING RIGGING SPECS

BOAT	KIT PART No. (6 digit)	ITEM PART No. (6 digit)	REV	QTY	DESCRIPTION	MAKE & TYPE	COL.	TERMINAL 1	TERMINAL 2	NOTES	DIA	LENGTH mm	FEET	IN
O423		113172	00	1	GENNEKER HALYARD	SAMSON XLS EXTRA	RED	SOFT EYE SNAPSHACKLE W2477	WHIPPING AND LOOP		7/16"	40000	131	2 13 / 16
O423	113143		00	1	GENNEKER HALYARD	SAMSON LSTC	RED	SOFT EYE SNAPSHACKLE WICHARD 2475	BURNT		7/16"	40000	131	2 13 / 16
O423	113143		00	1	GENNEKER TACK STROP	SAMSON LSTC	BLACK	BURNT	BURNT		1/2"	7000	22	11 9 / 16
O423	113143		00	2	GENNEKER SHEET - twin sheet system	SAMSON LSTC	RED	BURNT	BURNT		7/16"	30000	98	5 1 / 16
O423		113178	01	1	GENNEKER TACK STROP	SAMSON LS	RED	SOFT EYE SNAPSHACKLE W2475	WHIPPING	1. optional.	1/2"	6097	20	0 1 / 16
O423		113177	00	1	GENNEKER SHEET - single sheet system	SAMSON XLS EXTRA	RED	SOFT EYE SNAPSHACKLE W2475	WHIPPING		7/16"	30000	98	5 1 / 16
O423			00	1	WHISKER POLE TOPPING LIFT	SAMSON XLS EXTRA	BLACK	SOFT EYE SNAPSHACKLE W2475	WHIPPING AND LOOP	1. optional.	3/8"	40000	131	2 13 / 16
O423			00	1	WHISKER POLE DOWNHAUL	SAMSON XLS EXTRA	RED	SOFT EYE SNAPSHACKLE W2475	WHIPPING AND LOOP	1. optional.	3/8"	25000	82	0 1 / 4
O423			00	1	JIB HALYARD #1	GLEISTEIN TASMANIA	BLUE	KNOT EYE 8mm D SHACKLE Z3639	BURNT	1. standard. 2. pre-installed on mast.	12mm	36000	118	1 5 / 16
O423			00	1	JIB HALYARD #2	SAMSON XLS EXTRA	GREEN	SOFT EYE SNAPSHACKLE W2475	WHIPPING AND LOOP	1. optional.	7/16"	36501	119	9 0 / 16
O423		113179	00	2	JIB SHEET	SAMSON LS	BLACK	WHIPPING	WHIPPING	1. standard.	1/2"	14500	47	6 7 / 8
O423			00	1	GENOA RF LINE	NEW ENGLAND DOUBLE BRAID	YELLOW	BURNT	BURNT	1. Supplied with profurl.	3/8"	30000	98	5 1 / 16
O423			00	1	MAIN HALYARD - classic mast	GLEISTEIN TASMANIA	BLACK	KNOT EYE 8mm D SHACKLE Z3637	BURNT	1. standard. 2. pre-installed on mast.	12mm	36000	118	1 5 / 16
O423			00	1	MAIN HALYARD - roller furling mast	GLEISTEIN TASMANIA	BLACK	KNOT EYE 6mm D SHACKLE Z56	BURNT	1. standard. 2. pre-installed on mast.	12mm	36000	118	1 5 / 16
O423		113180	00	1	MAINSHEET	SAMSON LS	GREY	SOFT EYE	WHIPPING AND LOOP	1. standard.	1/2"	23000	75	5 1 / 2
O423			00	1	MAIN BOOM TOPPING LIFT - classic mast	GLEISTEIN TASMANIA	YELLOW	KNOT EYE 7mm D SHACKLE Z3639	BURNT	1. standard. 2. pre-installed on mast.	8mm	31000	101	8 7 / 16
O423			00	1	MAIN BOOM TOPPING LIFT - roller furling mast	GLEISTEIN TASMANIA	YELLOW	KNOT EYE 7mm D SHACKLE Z3639	BURNT	1. standard. 2. pre-installed on mast.	8mm	31000	101	8 7 / 16
O423			00	1	VANG LINE	GLEISTEIN TASMANIA	RED	BURNT	BURNT	1. standard - supplied with vang.	10mm	13000	42	7 13 / 16
O423		113154	01	2	MAINSHEET TRAVELLER CONTROL LINE	SAMSON LS	WHITE	SOFT EYE	WHIPPING	1. standard.	5/16"	9500	31	2 0 / 16
O423			00	1	MAIN RF INHAUL LINE	GLEISTEIN TASMANIA	YELLOW	BURNT	BURNT	1. standard - supplied with mast.	10mm	18000	59	0 5 / 8
O423			00	1	MAIN RF OUTHAUL LINE	GLEISTEIN TASMANIA	BLACK	BURNT	BURNT	1. standard - supplied with boom.	12mm	18000	59	0 5 / 8
O423			00	1	OUTHAUL LINE #1- classic mast	GLEISTEIN TASMANIA	RED	BURNT	KNOT EYE ON SINGLE BLOCK+ BECKETT Z253	1. standard - supplied with boom.	8mm	3000	9	10 1 / 8
O423			00	1	OUTHAUL LINE #2- classic mast	GLEISTEIN TASMANIA	RED	KNOT EYE	BURNT	1. standard - supplied with boom.	8mm	4000	13	1 1 / 2
O423			00	1	REEF 1 - classic mast	GLEISTEIN TASMANIA	GREEN	BURNT	BURNT	1. supplied with boom.	10mm	22000	72	2 1 / 8
O423			00	1	REEF 2 - classic mast	GLEISTEIN TASMANIA	YELLOW	BURNT	BURNT	1. supplied with boom.	10mm	31000	101	8 7 / 16

XIV) FRESH WATER SYSTEM

The fresh water system supplies the sink in the galley, the wash basin and shower in all of the heads, and the transom shower. This system is pressurized by an electric pump. There is a filter between the water tank manifold and the pump. It is necessary to check and clean this filter regularly.

Never run an electric pump when the tank is empty. It may burn out the pump.

To prevent any over pressure in the system during filling, never force the filling nozzle deep down the filler pipe and keep an eye on the vent hole(s) through which the excess water will be discharged.

When the system has not been used for a long period of time, the tanks and pipes should be cleansed with an acetic acid solution (white vinegar).

The water drains out from the sink and wash basins through their own thru-hulls. Close them when the water system is not used.

LAY OUT OF THE FRESH WATER SYSTEM

ALL VERSIONS

FRESH WATER FILL AND TANK CIRCUIT

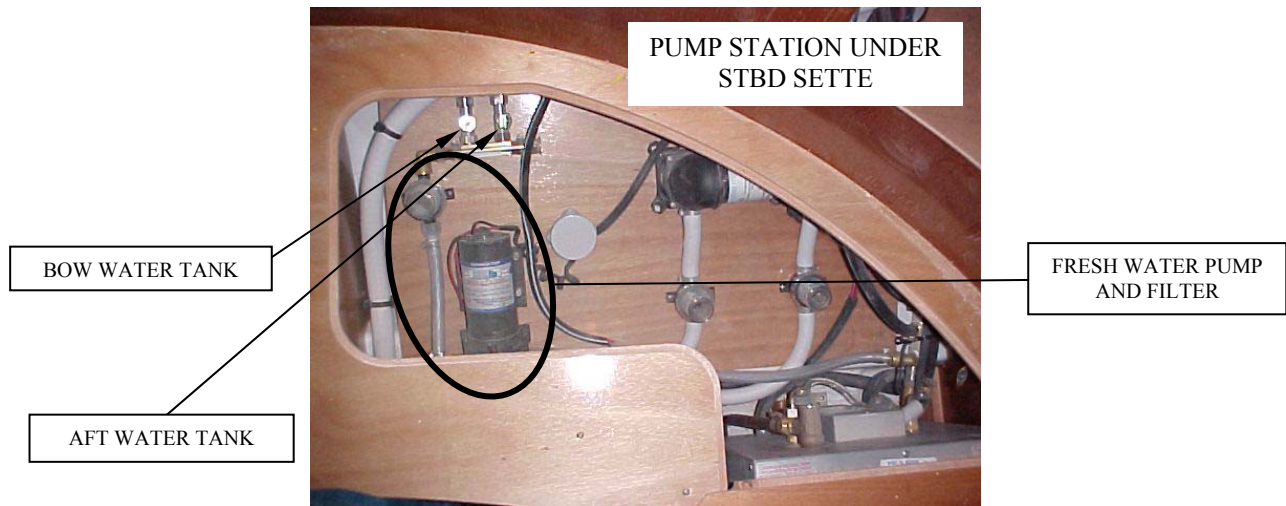
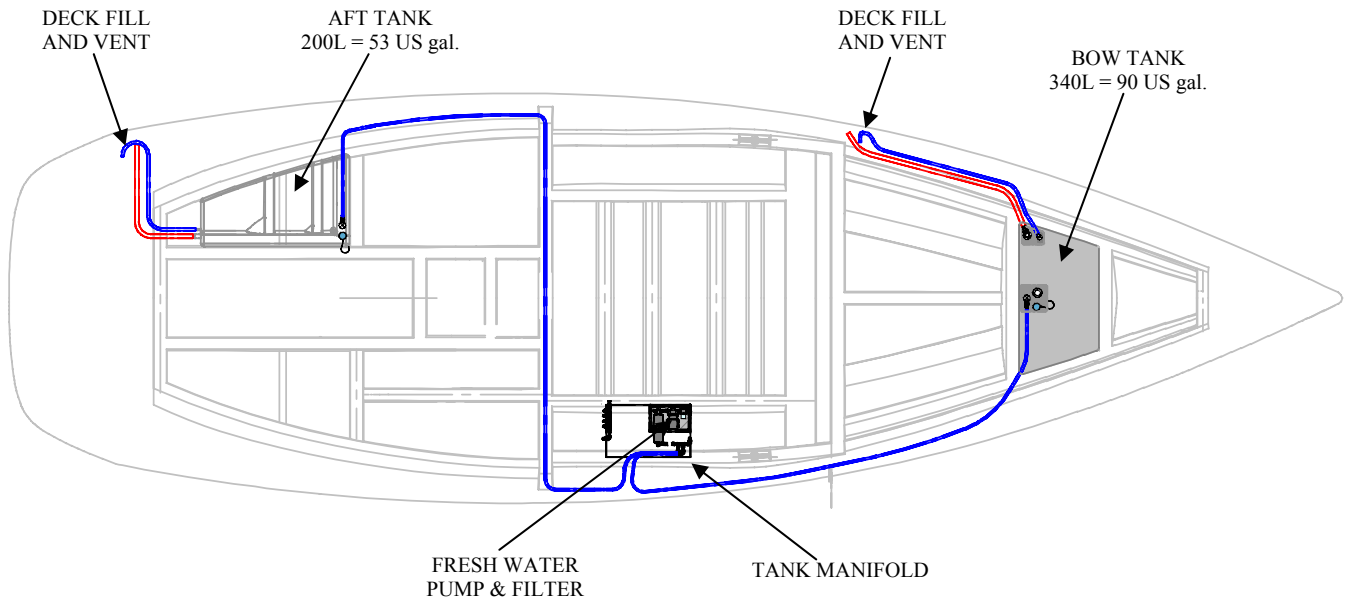

2 CABIN / 2 TOILET

COLD WATER CIRCUIT

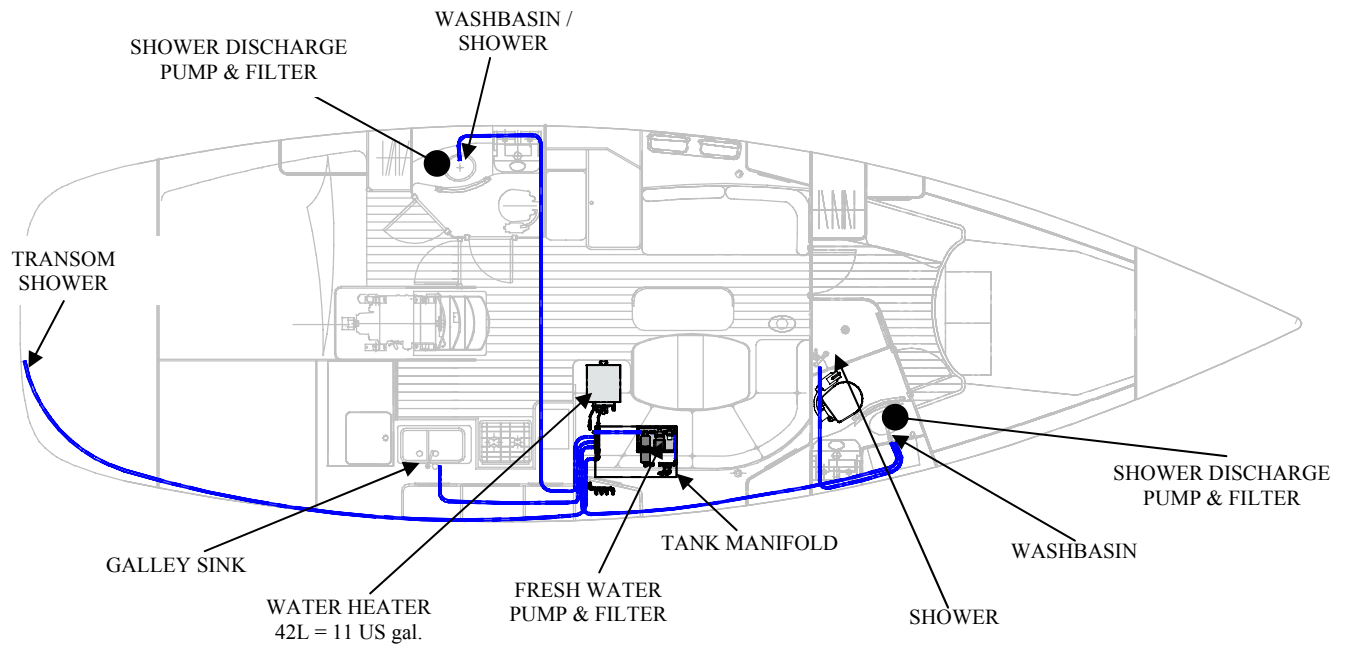

HOT WATER CIRCUIT

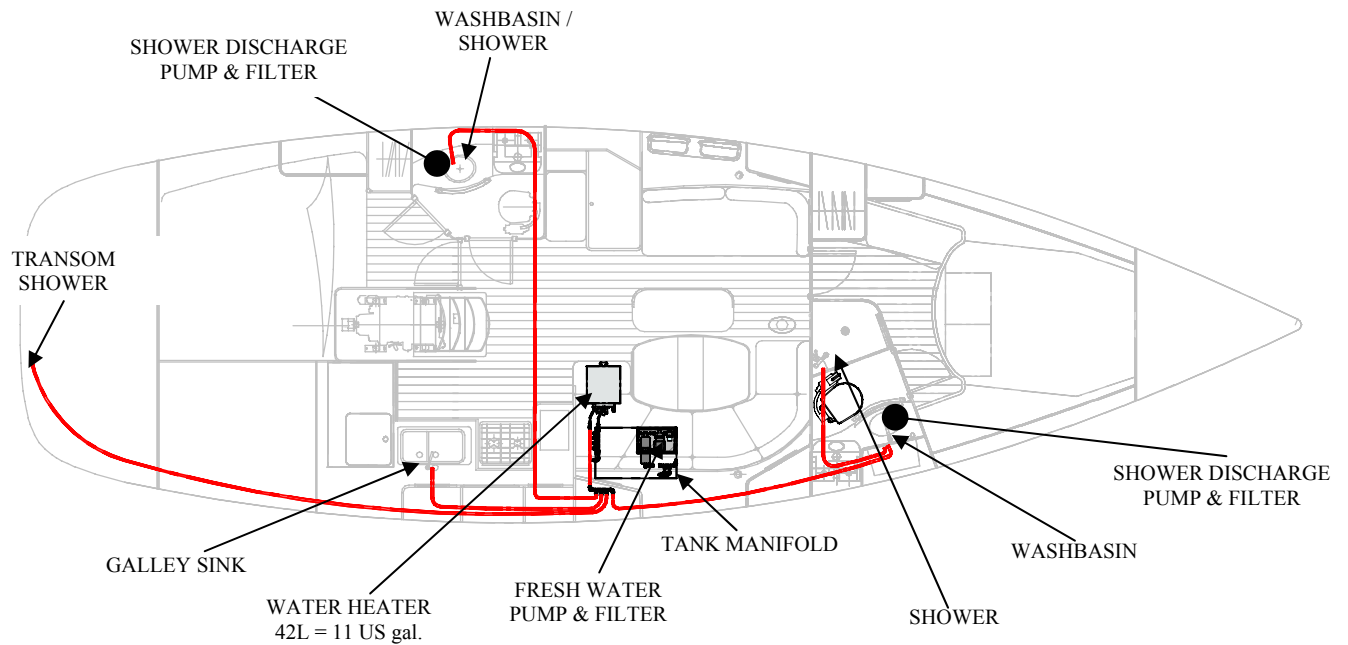

3 CABIN / 2 TOILET

COLD WATER CIRCUIT

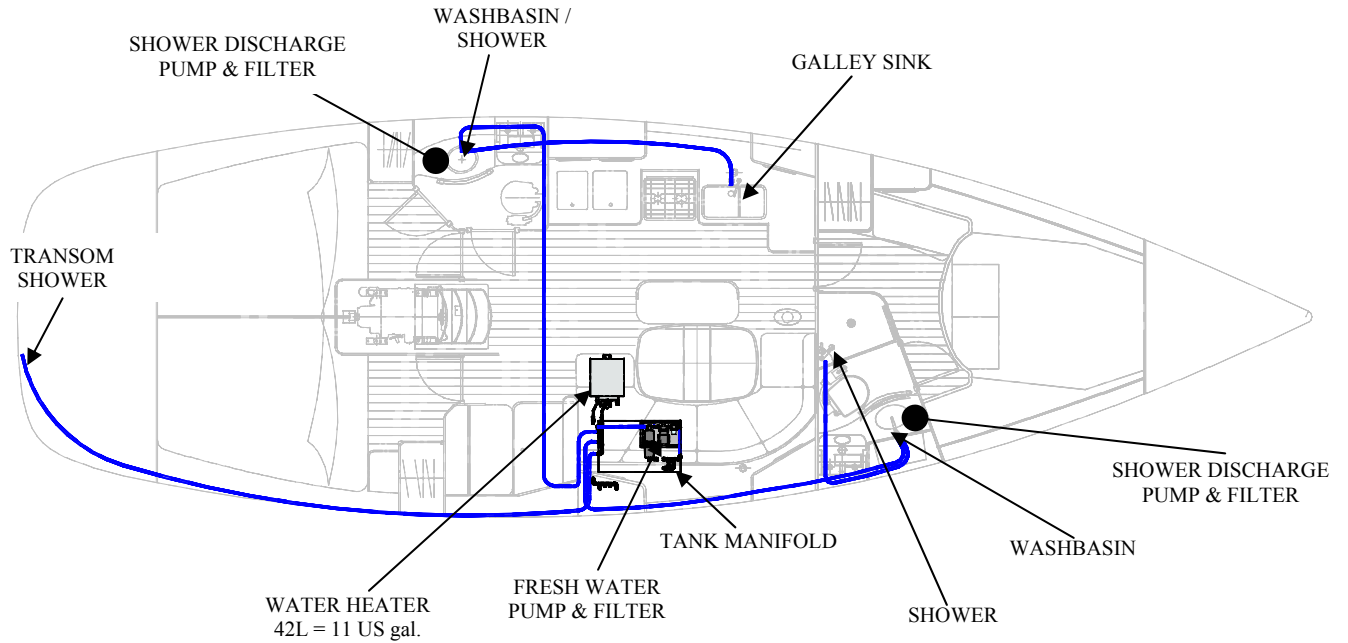

HOT WATER CIRCUIT

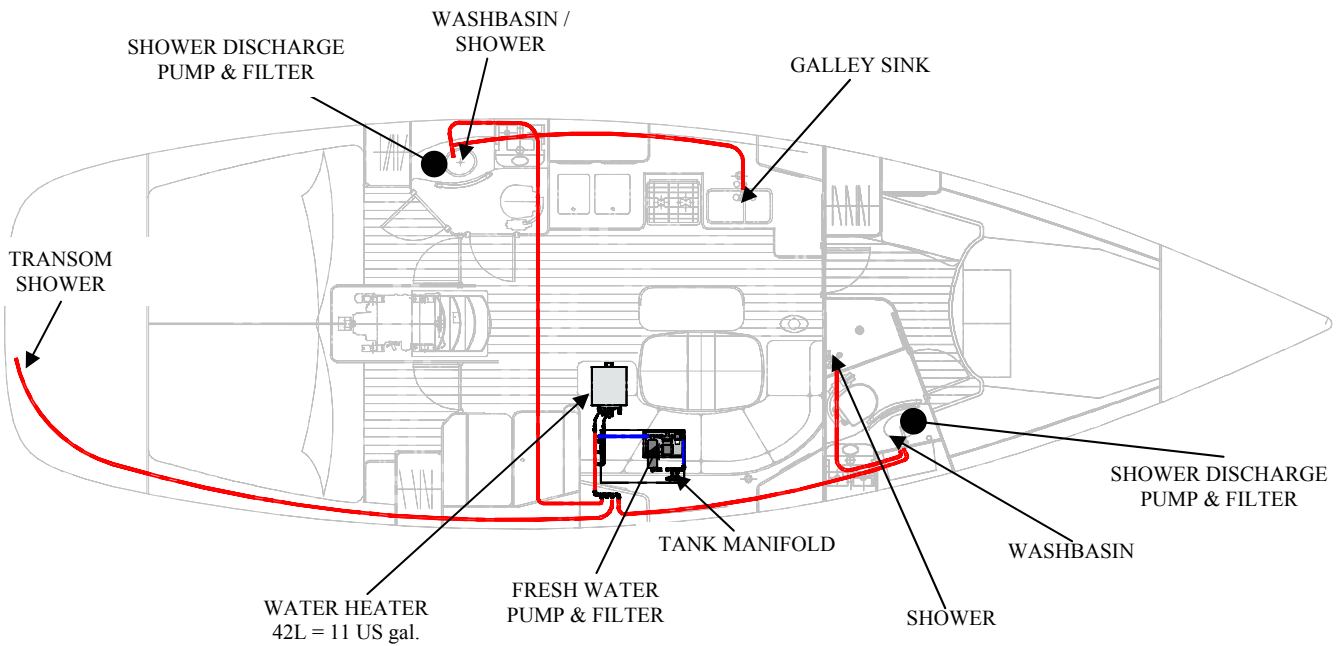

XV) BILGE PUMP SYSTEM

Make sure the bilge pump system is in good working order before you put out to sea.

Acquaint yourself with the way the bilge pump system of your boat works:

- **Locate the manual bilge pump and the handle.**
-
- **Locate the on switch of the electric bilge pump and get to know how the seacocks work (for the boats fitted with an electric bilge pump).**

(See the lay out drawing of the system - next page)

Make sure that the bilge pump intake strainer is not blocked with dirt.

Regularly clean the intake strainer on the sump and the filter of the system.

PUMP STATION UNDER
STBD SETTE



ELECTRIC BILGE PUMP #1
AND FILTER

ELECTRIC BILGE PUMP #2
AND FILTER

LAY OUT OF THE BILGE PUMP SYSTEM

ALL VERSIONS

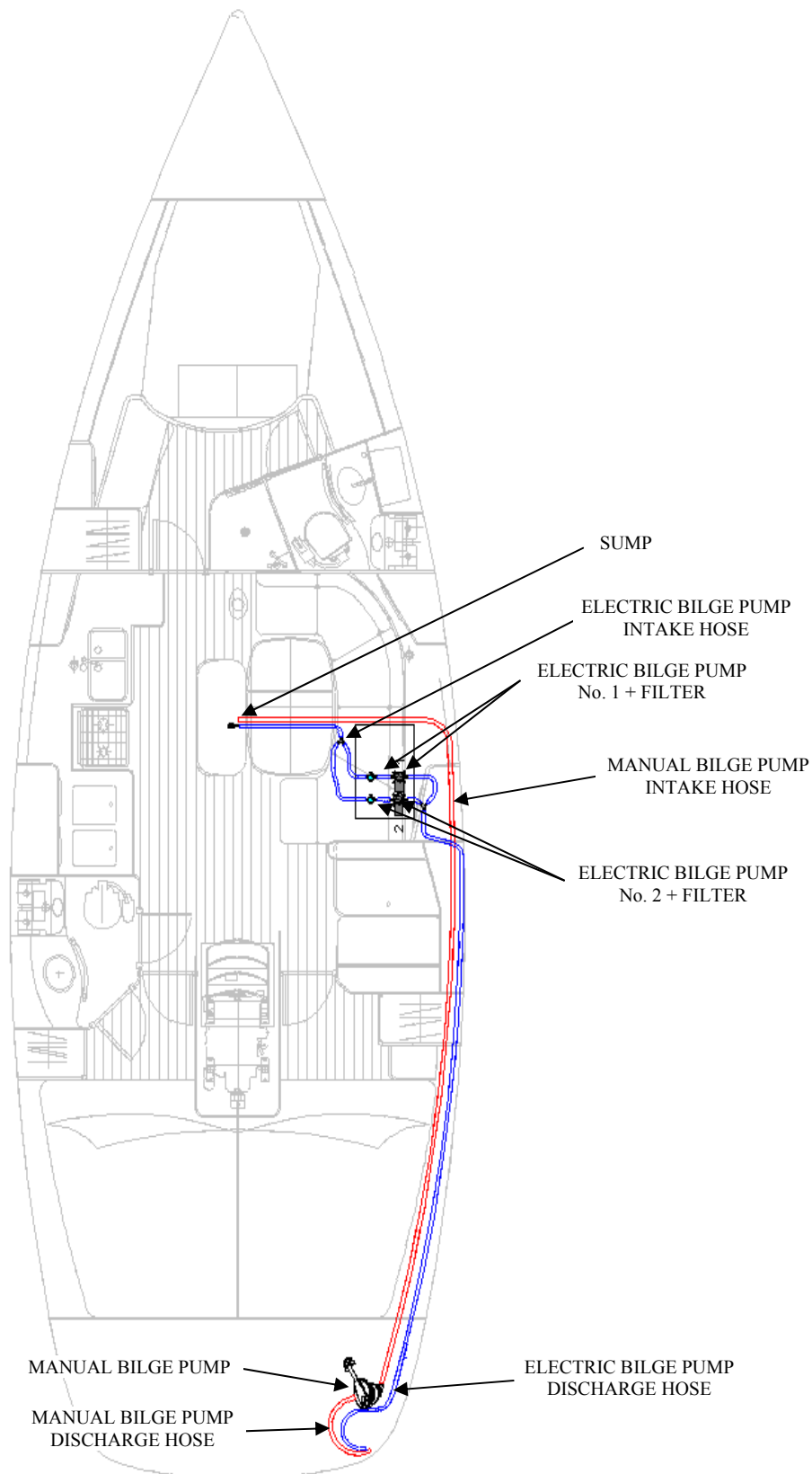

XVI) SEACOCKS AND THRU-HULLS

Close all the seacocks when you leave the boat.

The toilet is situated below the waterline; get into the habit of systematically closing the seacocks after each use.

Make sure that all seacocks, which are not used, are closed before you put out to sea.

Opening and closing of the seacocks

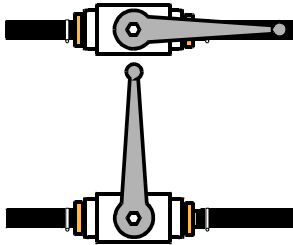

Open

Closed

REF	DESCRIPTION
1	Head Discharge
2	Head Intake
3*	Washbasin / Shower Discharge
4	Optional Waste Tank Discharge
5	Galley Sink Discharge
6	Engine Cooling Water Intake
7	Ice Box Draining
8	Stern Tube Cooling Intake Valve
9	Speed/Log, Depth Sounder Thruhulls
10	Electric Bilge Drain
11	Manual Bilge Drain
12	Exhaust
13	Sail Locker Drain
14	LPG Locker Drain

* The washbasin and shower discharge, connect to the same thru hull through a set of 1/4 turn valves and a tee. The washbasin discharge will be the one with a slightly larger diameter hose.

Operation of three-way valve for toilets

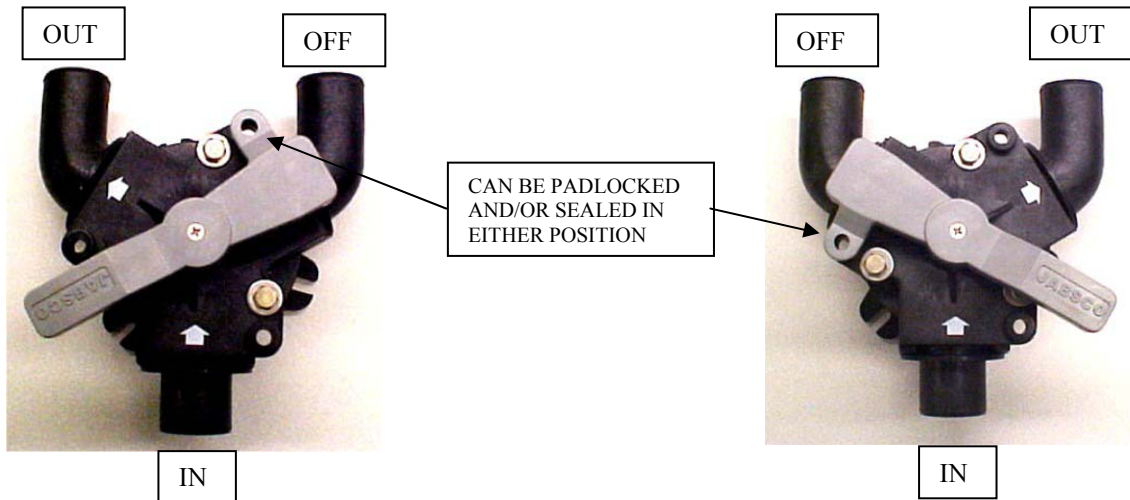

SEACOCK AND THRU-HULL LAY OUT

2 CABIN / 2 TOILET

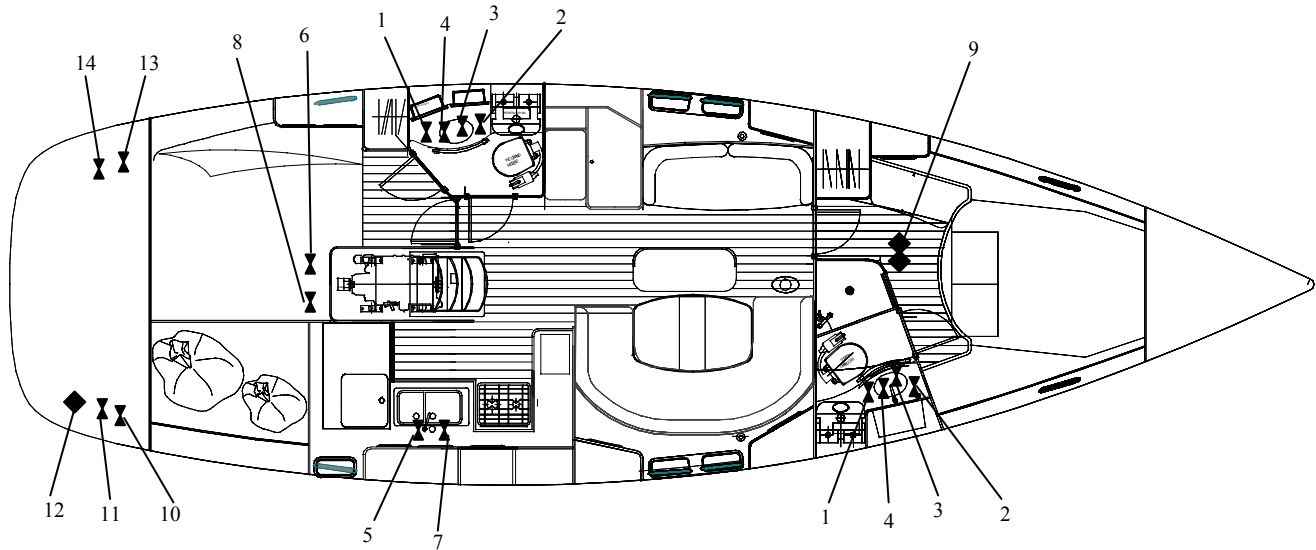

3 CABIN / 2 TOILET

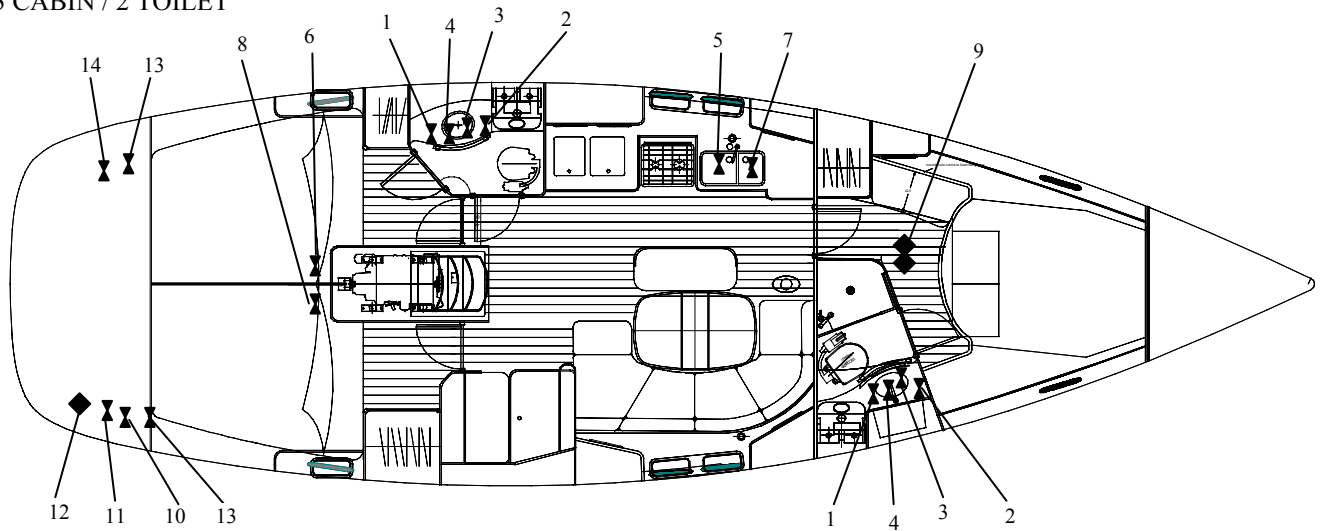

XVII) ELECTRIC SYSTEMS

When the voltage is not specified, all the functions or panels are in 12 Volts.

12V Electric System

Never work on a live electric fitting.

Never tamper with an electric fitting. Call in a technician qualified in marine electricity.

The batteries must be carefully and safely stowed.

In order to prevent a short circuit between the battery terminals, do not store conductive objects near the batteries (e.g. metal tools, ...)

Never alter the specifications of the breakers, which protect against overload.

Never fit or replace the electric materials or appliances with components, which exceed the system amperage.

110V-220V Electric System

Boats are fitted with a 110V/60Hz or a 220V/50Hz system (some as standard, others as an option, depending on the models). We advise you to follow these steps in order to avoid the risk of electric shock and fire.

Do not work on a live fitting.

Connect the boat / shore supply cable to the boat before you plug it into the shore supply socket with the breaker off. Turn the breaker on last.

Do not immerse the boat / shore cable socket.

Turn off the shore supply switch on board before you plug in or unplug the boat / shore supply cable.

Do not tamper with the connections of the Boat / shore supply cable. Use only compatible connections.

Never swim in a marina around boats connected to shore power. If necessary for maintenance unplug the boat being worked on and surrounding boats.

ELECTRICITY LAY OUT

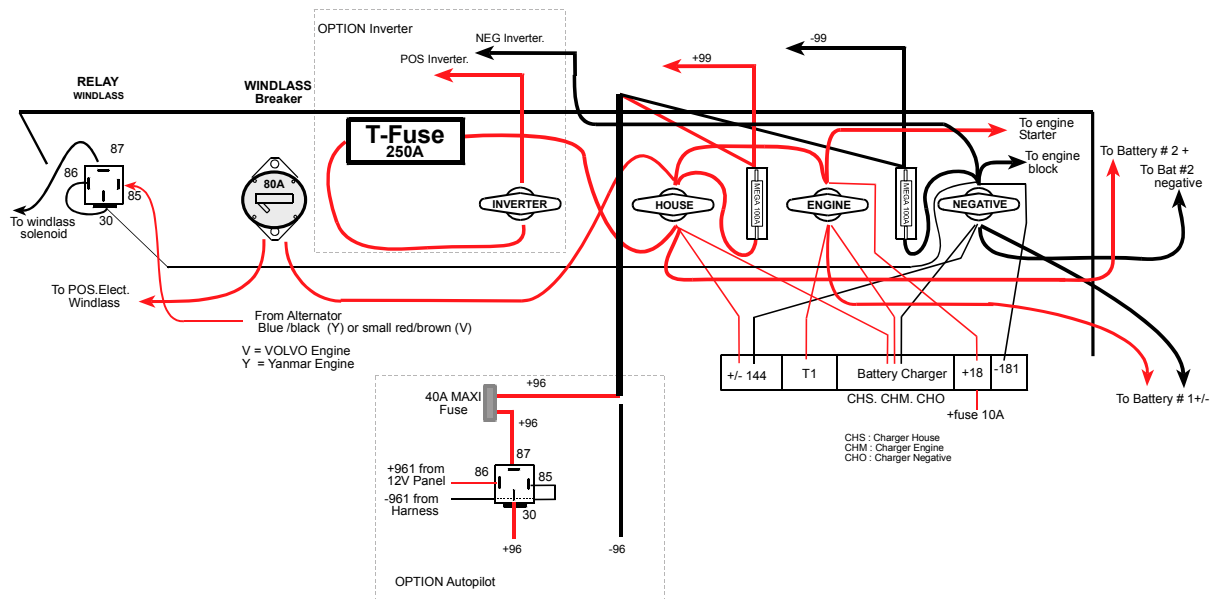

BATTERY SWITCH OPERATION

Never turn the negative battery switch off while engine is running.

Never turn all positive switches off while engine is running.

Battery 1 is the engine / start battery

Battery 2 is the service / house battery

Negative battery switch controls ground {DC12V negative} for all batteries.

To charge a battery with the engine the positive switch must be in the on position.

WARNING: Do not turn both positive battery switches off while engine is running

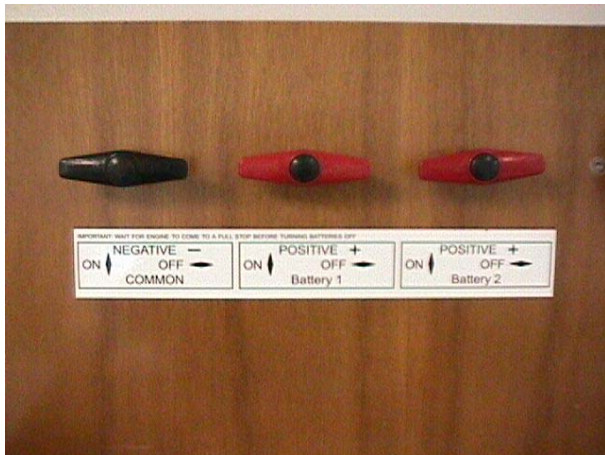

Everything is OFF, no 12V DC power
(when leaving the boat unattended)



Everything is ON, 12VDC power available
to start engine and/or run equipment

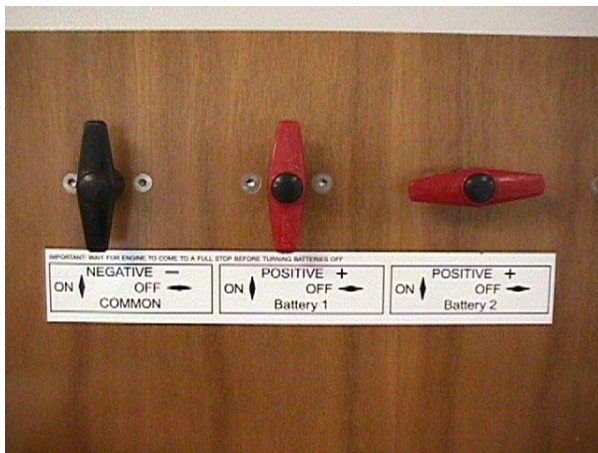

Configuration to start engine ,while
house/service is off or down

You can turn house switch ON, while
engine is running to charge house.



Engine is off , Run equipment from house only
(like at anchorage)

12V PANEL

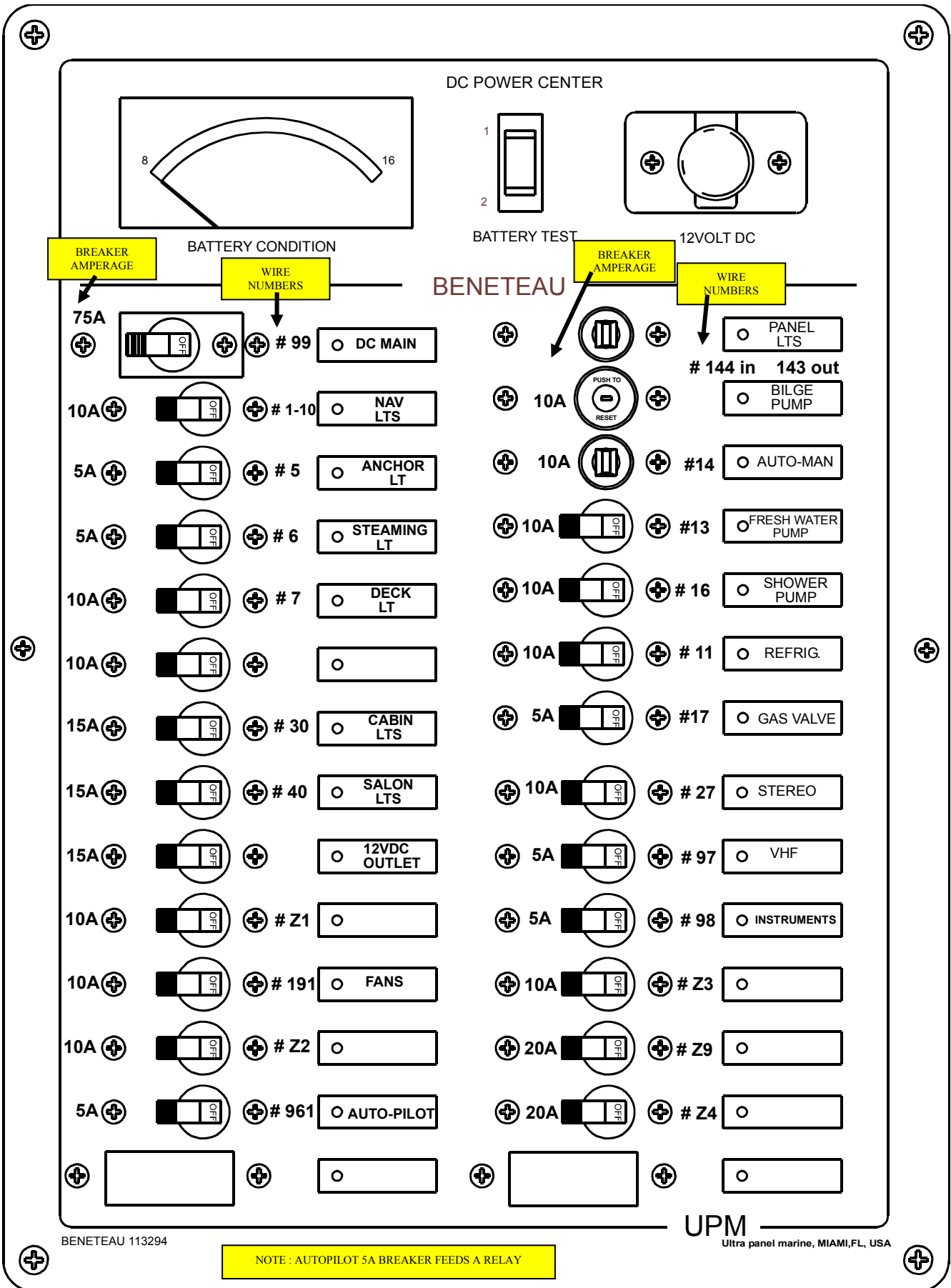

WAGO BLOCK

Hull loose wires
21,22,131,142,145,171

Deck loose wires:
4,

Move 50 to 30

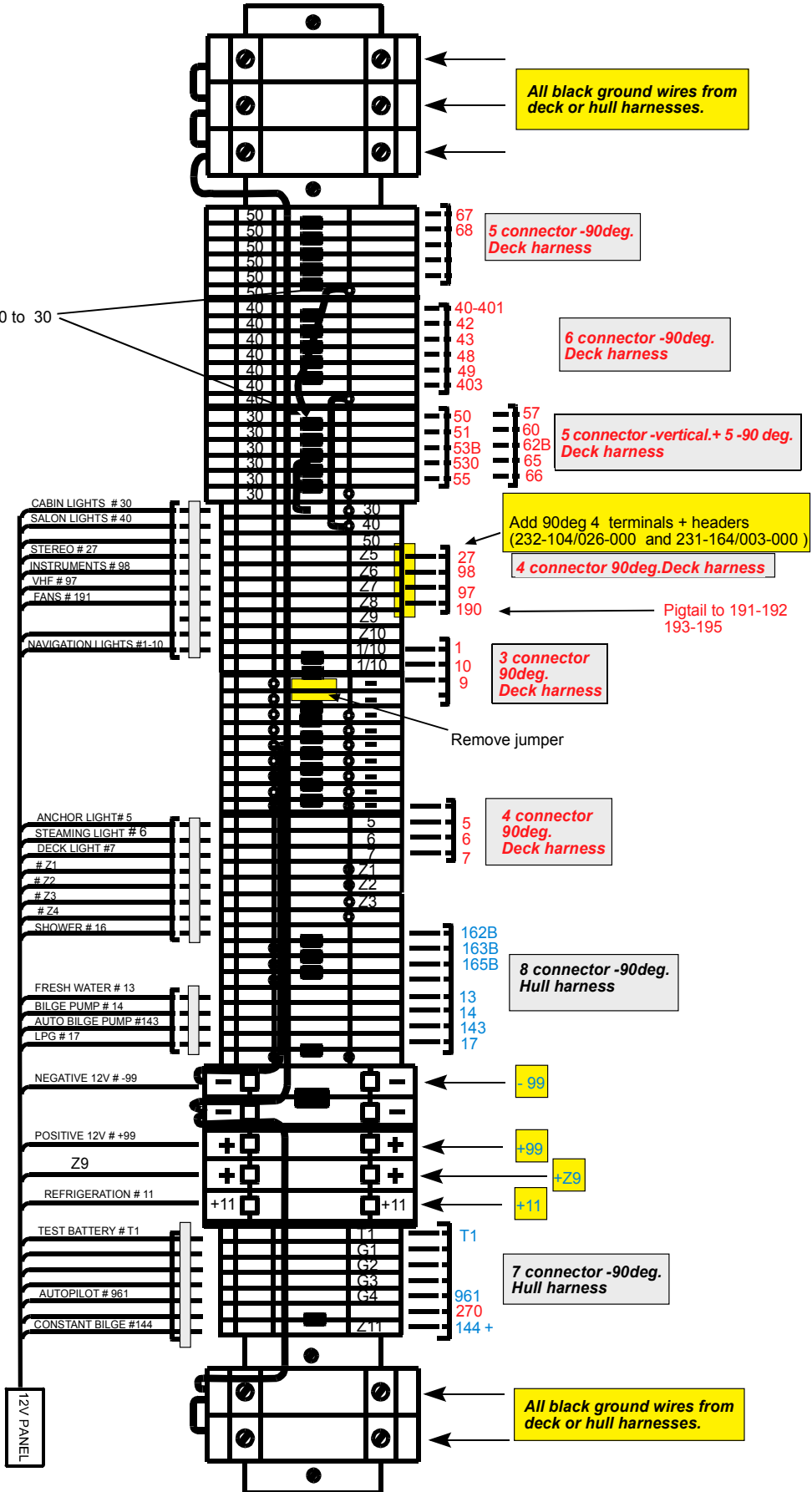

HULL HARNESS LAYOUT

2 Cabin / 2 Toilet Version

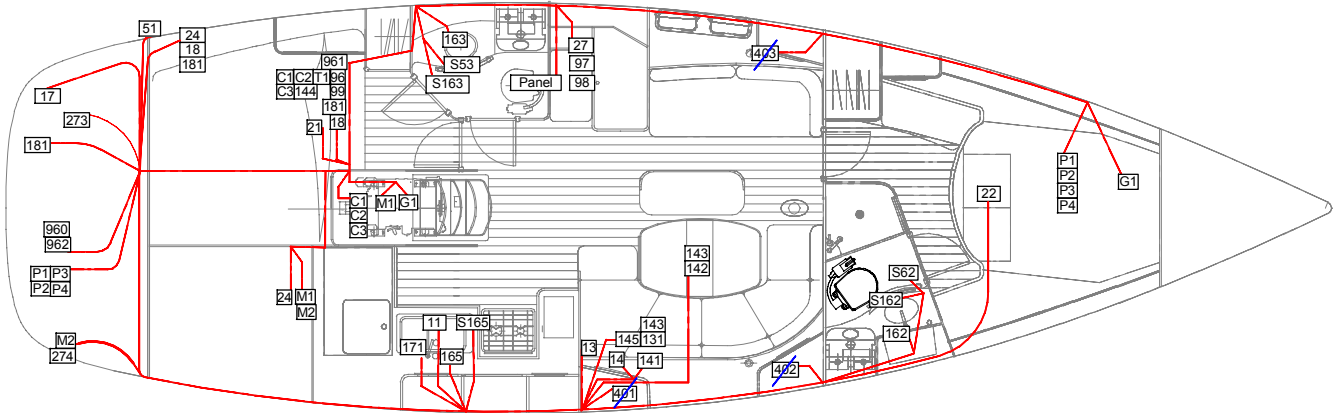

162	14/2	R	20,400	105° tinned		STBD FWD shower drain pump
S62	16/2	R	17,800		on connector	STBD FWD shower ceiling light switch
402	16/2	R/B	3,300		picked from 401	STBD salon fwd reading light
401	10/2	R/B	15,800		On connector	STBD salon aft reading light
14	14/2	R/B	15,500			Bilge pump 1
148	14/2	R/B	15,500			Bilge pump 2
13	14/2	R/B	15,500			Fresh water pressure
142	14/2	R/B	17,100			Bilge pump (mrg's)
131	16/1	R	15,500			Fresh water pump light (mrg's)
145	16/2	R/B	15,500			bilge pump alarm (marion)
143	10/1	R	21,500			float switch bilge pump (marion)
11	6/2	R/B	15,000			Fridge
171	16/2	R/B	14,800			Propane solenoid light
165	14/2	R	18,600			Ice box drain pump
		B	15,000			
M2	8/1	YG	8,600			Fuel tank ground
P5,P6,P1	14/1	B	16,300			Bow thruster 12V
	14/1	R				
181	14/2	R	6,500		Not by the panel	Fan/blower- engine panel to blower
		B	5,900			
17	16/2	R/B	10,500			Propane solenoid
96	8/2	R	6,200		Not by the panel	12V autopilot course computer
		B	4,000			
962	8/2	R/B	3,100			12V autopilot drive unit
961	16/2	R/B	6,200			12V autopilot relay
51	16/2	R/B	10,700			Port aft cabin aft reading light
24	16/2	R/B	7,600			STBD aft fuel tank gauge
241	16/2	R/B	0,100			12V Fuel tank stbd aft
18	14/1	R	6,400		Not by the panel	Fan blower. BSW1+ to engine panel
21	16/2	R/B	5,900			Port aft water tank gauge
99	4awg /2	R/B	6,000	105° tinned		Main 12V panel +/-
WIRE. #	SIZE AWG	COLOR	L. (m)	Code	NOTE	DESIGNATION
R	DESCRIPTION	DATE	DIMENSION:	TOL GEN :	Material:	VISA
			Beneteau 423 Hull Harness - 2C2T		DATE : 8/12/02	
					BY: P.LG	
C	length -11-165-delete 401 / 2 / 3	10/02	BENETEAU USA P.O. Drawer 1218 Marion, SC 29571 (803) 423-4201		Part No:	058680-C
B	143 14awg to 10 awg	9/02				
A	remove 270----> deck	9/02				
THIS DOCUMENT IS PROPRIETARY AND REPRODUCTIONS MUST BE AUTHORIZED BY BENETEAU. DRAWN BY BENETEAU - SPECIFIED AND DESIGNED BY PRODUCT MANUFACTURER.						

22	16/2	R/B	19,800	105° tinned		FWD water tank gauge
M1	8/1	YG	3,500		Not by the panel	Ground fuel tank to engine
G1	14/2	R/B	11,900		Not by the panel	Elec.windlass relay
CHS	8/1	R	2,200		Not by the panel	Charger / engine
CHM	8/1	R	2,200		Not by the panel	Charger / house
CHO	8/1	N	2,200		Not by the panel	Charger / negative
144	14/2	R/B	6,000			12V constant power
T1	16/1	R	6,000			Engine bat. test
163	14/2	R	7,000			Port aft shower drain pump
		B	4,000			Port aft shower ceiling light switch
S53	16/2	R	4,400		On connector	Port cabin fwd reading light
403	16/2	R/B	5,100		On connector	Port cabin fwd reading light
97	16/2	R/B	1,300		On connector	12V -VHF
98	16/2	R/B	1,300		On connector	12V nav instruments
274	16/2	R/B	11,700		Not by the panel	STBD cockpit speaker
273	16/2	R/B	10,700		Not by the panel	Port cockpit speaker
964	16/2	R/B	3,100	105° tinned	Not by the panel	Autopilot linear drive clutch
WIRE. #	SIZE AWG	COLOR	L. (m)	Code	NOTE	DESIGNATION
R	DESCRIPTION	DATE	DIMENSION:	TOL GEN :	Material:	VISA
			Beneteau 423 Hull Harness - 2C2T		DATE : 8/12/02	
					BY: P.LG	
C	length -11-165-delete 401 / 2 / 3	10/02	BENETEAU USA P.O. Drawer 1218 Marion, SC 29571 (803) 423-4201		Part No:	058680-C
B	143 14awg to 10 awg	9/02				
A	remove 270----> deck	9/02				
THIS DOCUMENT IS PROPRIETARY AND REPRODUCTIONS MUST BE AUTHORIZED BY BENETEAU. DRAWN BY BENETEAU - SPECIFIED AND DESIGNED BY PRODUCT MANUFACTURER.						

HULL HARNESS LAYOUT

3 Cabin / 2 Toilet Version

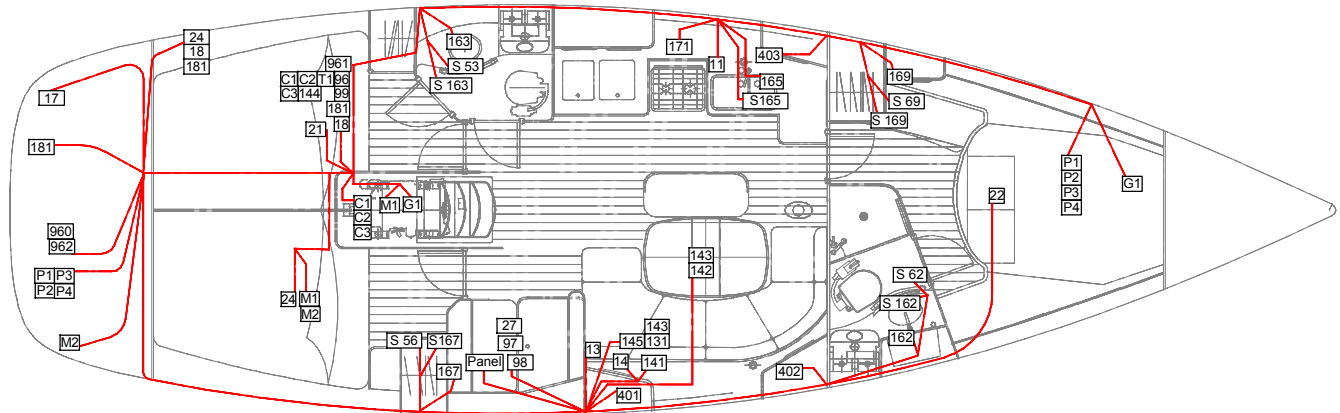

WIRE #	SIZE AWG	COLOR	L. (m)	Code	NOTE	DESIGNATION
22	16/2	R/B	7.300			FWD water tank gauge
162	14/2	R	7.90	105°		STBD FWD shower drain pump
		B	4.90			
S 62	16/2	R	5.300		On connector	STBD FWD shower ceiling light
402	16/2	R/B	5.200		Picked from 401	STBD salon fwd reading light
401	16/2	R/B	2.700		On connector	STBD salon aft reading light
14	14/2	R/B	3.000			Bilge pump 1
148	14/2	R/B	3.000			Bilge pump 2
13	14/2	R/B	3.000			Fresh water pressure
142	14/2	R/B	4.600			Bilge pump (mrg's)
131	16/1	R	3.000			Fresh water pump light (mrg's)
145	16/2	R/B	3.000			Bilge pump alarm (marion)
143	10/1	R	9.000			Float switch bilge pump (marion)
11	6/2	R/B	17.800			Fridge
171	16/2	R/B	17.600			Propane solenoid light
165	14/2	R	21.400			Ice box drain pump
		B	17.80			
M2	8/1	Y/G	8.600			Fuel tank ground
P5,P6,P7	14/1	B	15.900			Bow thruster 12V
P1	14/1	R	6.500		Not by the panel	Fan/blower-engine panel to blower
		B	5.900			
17	16/2	R/B	11.100		Not by the panel	Propane solenoid
96	8/2	R	6.200		Not by the panel	12V autopilot course computer
		B	4.000			
962	8/2	R/B	3.1000			12V autopilot drive unit
961	16/2	R/B	11.200			12V autopilot relay
24	16/2	R/B	7.600			STBD aft fuel tank gauge
241	16/2	R/B	0.100			12V Fuel tank stbd aft
18	14/1	R	6.400		Not by the panel	Fan blower. BSW1+ to engine panel
21	16/2	R/B	10.900			Port aft water tank gauge
99	4awg /2	R/B	11.000	105°		Main 12V panel +/-

WIRE #	SIZE AWG	COLOR	L. (m)	Code	NOTE	DESIGNATION
M1	8/1	Y/G	3.500	105°		Ground fuel tank to engine
G1	14/2	R/B	11.700		Not by the panel	Elec.windlass relay
CHS	8/1	R	2.200		Not by the panel	Charger / engine
CHM	8/1	R	2.200		Not by the panel	Charger / house
CH0	8/1	B	2.200		Not by the panel	Charger / negative
144	14/2	R/B	11.000			12V constant power
T1	16/1	R	11.000			Engine bat. test
163	14/2	R	16.600			Port aft shower drain pump
		B	13.300			
S53	16/2	R	13.700		On connector	Port aft shower ceiling light switch
403	16/2	R/B	47.00		On connector	Port salon fwd reading light
97	16/2	R/B	1.300		On connector	12V -VHF
98	16/2	R/B	1.300		On connector	12V nav.instruments
169	14/2	R	20.900			STBD FWD shower drain pump
		B	17.900			
S69	14/2	R	18.300		On connector	STBD fwd bath ceiling light switch
167	14/2	R	6.4000			STBD aft shower drain pump
		B	3.400			
S56	14/2	R	3.800		On connector	STBD aft toilet ceiling light switch
274	16/2	R/B	7.300		Not by the panel	STBD cockpit speaker
273	16/2	R/B	11.300		Not by the panel	Port cockpit speaker
964	16/2	R/B	3.100	105°		Autopilot linear drive clutch

R	DESCRIPTION	DATE	DIMENSION:	TOL GEN:	Material:	VISA
					DATE: 8/12/02	
					BY: PLG	
					F6	
					Part No:	
					059074-C	

Beneteau 423
 Hull Harness - 3C2T
BENETEAU USA
 P.O. Drawer 1218
 Marion, SC 29571
 (803) 423-4201

R	DESCRIPTION	DATE	DIMENSION:	TOL GEN:	Material:	VISA
					DATE: 8/12/02	
					F6	
					Part No:	
					059074-C	

Beneteau 423
 Hull Harness - 3C2T
BENETEAU USA
 P.O. Drawer 1218
 Marion, SC 29571
 (803) 423-4201

DECK HARNESS LAYOUT

3 Cabin / 2 Toilet Version

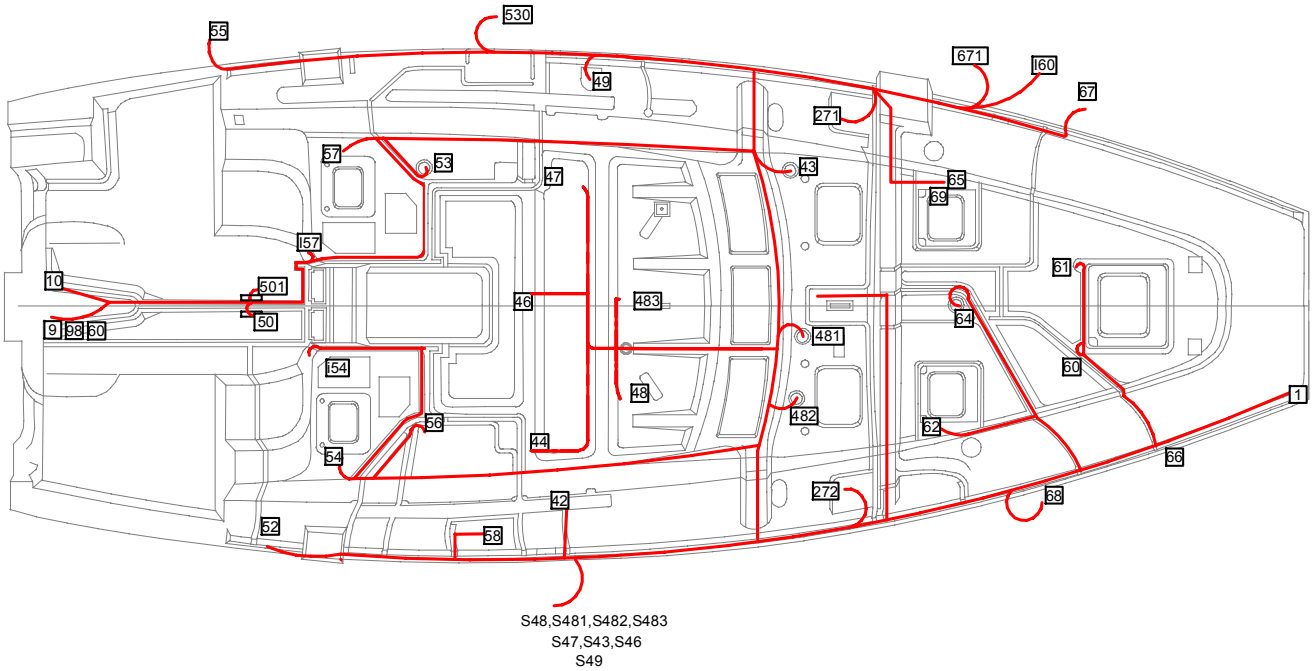

Part #	Size	Color	Length (m)	Code	Note	Designation
65	16/2 R/B	11.700	105° Tinned			FWD cabin ceiling fan
600	16/2 R/B	10.500			picked from 65	FWD cabin ceiling fan
601	16/2 R/B	1.300			picked from 600	FWD cabin ceiling fan
193	16/2 R/B	9.300				FWD cabin port fan
67	16/2 R/B	10.300				FWD cabin port reading light
671	16/2 R/B	2.800			picked from 67	Port fwd bath sink light
271	16/2 R/B	8.400			Not by the panel	Port salon speaker
191	16/2 R/B	8.200				Port salon FWD fan
69	16/2 R/B	9.900			switch on connector	Port FWD bath ceiling light
57	16/2 R/B	15.850				Port aft cabin ceiling light
53	16/2 R/B	10.800			switch at connector	Port aft shower ceiling light
55	16/2 R/B	11.000				Port aft cabin port reading light
195	16/2 R/B	10.900				Port aft cabin fan
530	2x1 R/B	9.900				Port aft shower sink light
49	16/2 R/B	7.900				Fluorescent galley
43	16/2 R/B	7.900				Ceiling light salon
47	16/2 R/B	5.450			picked from 43	Ceiling light salon
46	16/2 R/B	3.000			picked from 47	Ceiling light salon
44	16/2 R/B	2.900			picked from 46	Ceiling light salon
48	16/2 R/B	8.500				Ceiling light salon table
483	16/2 R/B	2.000			picked from 48	Ceiling light salon table
482	16/2 R/B	3.200			picked from 483	Ceiling light salon table
481	16/2 R/B	1.150			picked from 482	Ceiling light salon table
1	14/2 R/B	9.1000				Running light- bow light
66	16/2 R/B	7.200				Fwd cabin STBD reading light
192	16/2 R/B	6.800	105° Tinned			FWD cabin STBD fan
VHF	COAX	8.300				VHF coax
WIRE #	SIZE AWG	COLOR	L. (m)	Code	NOTE	DESIGNATION
R	DESCRIPTION	DATE	DIMENSION:	TOL GEN:	Material:	VISA
Beneteau 423 Deck Harness - 3C2T			F6			
BENETEAU USA P.O. Drawer 1218 Marion, SC 29571 (803) 423-4201			Part No: 059073-C			
THIS DOCUMENT IS - PROPRIETARY AND REPRODUCTIONS MUST BE AUTHORIZED BY BENETEAU DRAWN BY BENETEAU - SPECIFIED AND DESIGNED BY PRODUCT MANUFACTURER.						

401	16/2 R/B	2.600	105° Tinned			STBD salon FWD reading light
402	16/2 R/B	6.000			picked from 401	STBD salon AFT reading light
62	16/2 R/B	8.850			switch on connector	STBD fwd bath ceiling light
64	16/2 R/B	2.250			picked from 62	STBD fwd bath ceiling light
L4	16/2 R/B	8.800			switch on connector	4 Cab version FWD cabins passage ceiling
68	16/2 R/B	5.200				STBD fwd bath sink light
272	16/2 R/B	4.700			Not by the panel	STBD salon speaker
190	16/2 R/B	4.500				STBD salon fwd fan
8	12/1 B	6.500				Common mast ground
4,5,6,7	14/1 R	6.500				Mast lights
9	16/2 R/B	16.100				Compass light
90	16/2 R/B	15.800				12V outlet
68	16/2 R/B	16.800			Looped at connector	12V Navigation instruments
10	16/2 R/B	17.000				Running light , stern light
50	16/2 R/B	13.150				STBD aft cabin port reading light
501	16/2 R/N	1.00			Picked from 50	Port aft cabin Stbd reading light
54	16/2 R/B	13.200				STBD aft cabin ceiling light
52	16/2 R/B	4.450				STBD aft cabin Stbd reading light
56	16/2 R/B	8.350			switch on connector	STBD aft toilet ceiling light
194	16/2 R/B	4.250				STBD aft cabin fan
58	16/2 R/B	2.800				STBD aft toilet sink light
42	16/2 R/B	3.900				Chart table red ceiling light
274	16/2 R/B	1.500			Not by the panel	STBD cockpit speaker
273	16/2 R/B	1.500			Not by the panel	Port cockpit speaker
270	16/1 R	0.100			Not by the panel	Stereo memory
27	16/2 R/B	1.800				12V-Stereo
279	16/1 R	0.100			Not by the panel	12V-Stereo antenna
97	16/2 R/B	1.300	105° Tinned			12V-VHF radio
WIRE #	SIZE AWG	COLOR	L. (m)	Code	NOTE	DESIGNATION
R	DESCRIPTION	DATE	DIMENSION:	TOL GEN:	Material:	VISA
Beneteau 423 Deck Harness - 3C2T			F6			
BENETEAU USA P.O. Drawer 1218 Marion, SC 29571 (803) 423-4201			Part No: 059073-C			
THIS DOCUMENT IS - PROPRIETARY AND REPRODUCTIONS MUST BE AUTHORIZED BY BENETEAU DRAWN BY BENETEAU - SPECIFIED AND DESIGNED BY PRODUCT MANUFACTURER.						

LOCATION OF 110 / 220V SOCKETS AND APPLIANCES

REF	DESCRIPTION
1	Shore Power Inlet
2	Battery Charger
3	110/220V Outlet
4	Water Heater

2 CABIN / 2 TOILET

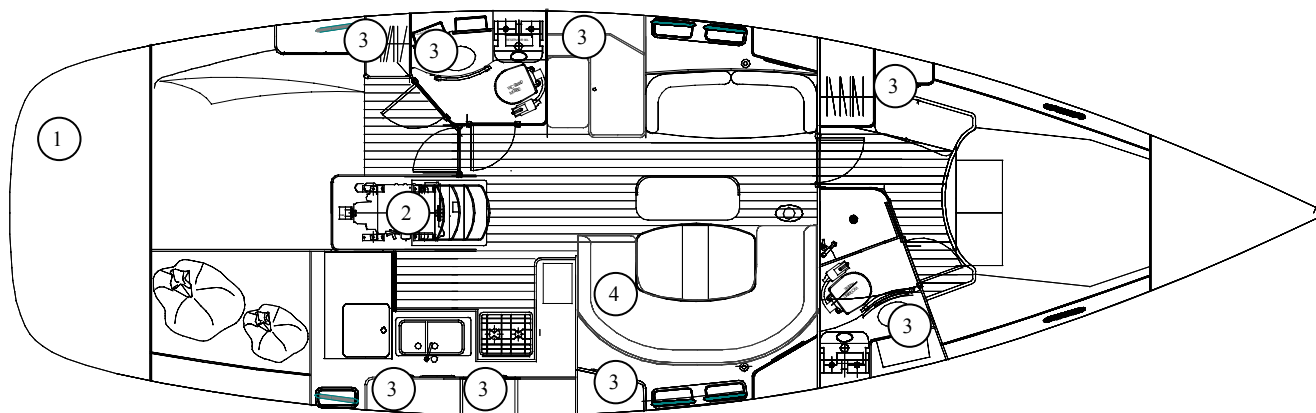

3 CABIN / 2 TOILET

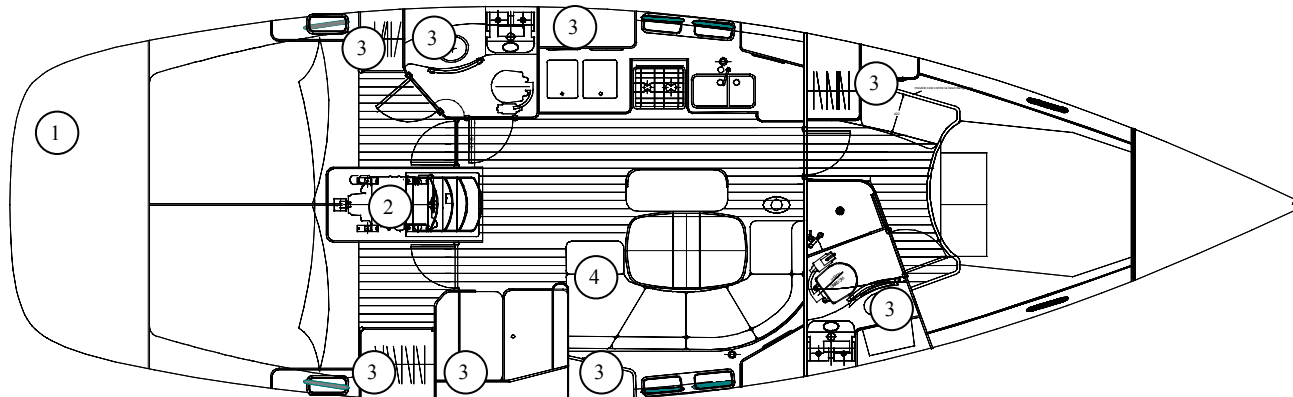

LAY OUT OF THE CONDUITS

2 CABIN / 2 TOILET

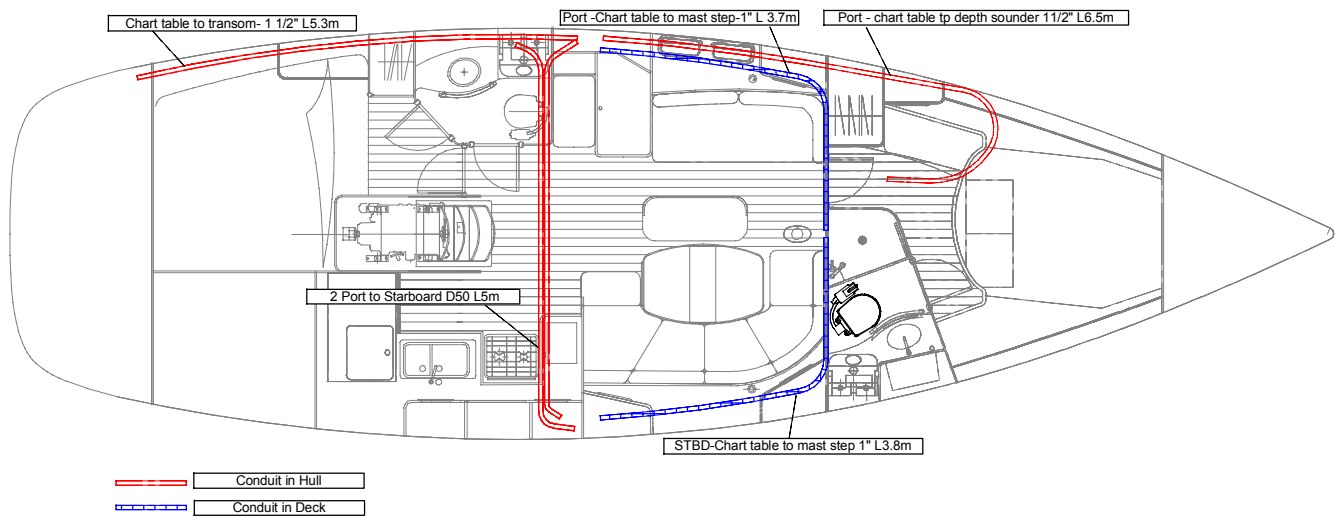

3 CABIN / 2 TOILET

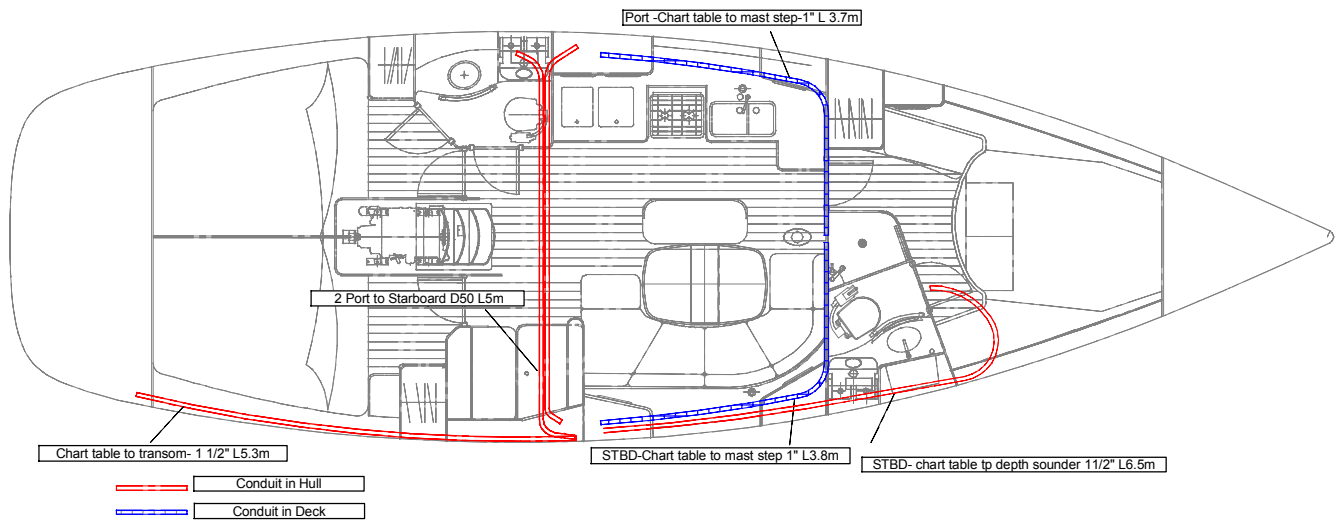

XVIII) LP GAS SYSTEM

Gas Stove

The boat is delivered without a fire extinguisher. It is your responsibility to comply with the laws and regulations of your country (Number, capacity, type and place of fire extinguishers). We advise you to install an extinguisher less than 5 meters away from the center of each berth, less than 2 meters away from the extinguisher aperture in the engine compartment, less than 2 meters away from any open flame device and less than 1 meter away from the helm pedestal or cockpit. We advise a total capacity of the portable extinguishers reaching 8A/64B, each extinguisher having at least a 5A/34B capacity. The CO2 extinguishers shall be used to fight fires in the galley and electric fires.

Do not install or store flammable materials above the stove (Curtains, papers, napkins, etc...)

Never leave the boat unattended when the LP gas appliances are in use.

The appliances, which use fuel, consume the oxygen within the cabin and release combustion products into the boat. It is necessary to ventilate the boat when using the gas cooking appliances. Do not obstruct the air vents of the boat.

Do not smoke or use an open flame when you are trying to locate a gas leak, change the gas bottle or work on the gas system.

If you smell gas or find that the burners have gone out by accident, (although appliance models cut off the gas automatically if the flames go out) turn off the gas valves and ventilate the boat in order to get rid of any residual gas. Find the cause of the problem before re-lighting the appliance.

Do not use cooking appliances to heat the inside of the boat.

Make sure that the burner valves are turned off before you turn on the 12V solenoid and the valve on the cylinder.

Turn off the 12V solenoid and the valve on the cylinder when you do not use the appliances.

Do not obstruct the access to the gas system components, in particular the access to the valves (cylinders and gas cooker).

The flexible hoses, which connect the gas cylinder at one end of the system and the stove at the other end, shall be changed in pursuance of the regulations in force in your country. Only use hoses, which meet the safety standards of your country.

Do not use the gas cylinder storage space to store other equipment.

Pay particular attention to keep in good condition the screw thread of the cylinder on which the regulator is attached. Check the condition of the regulator every year and change it if necessary. Use a regulator identical to the one which is fitted.

Make sure that the valve of the empty cylinder is turned off and disconnected from the system.

Do not use ammonia-based products to clean any part of the system or to discover a leak.

The LP gas system should be checked for leaks on a regular basis. See the manual provided with the stove for instructions.

LAY OUT OF THE GAS SYSTEM

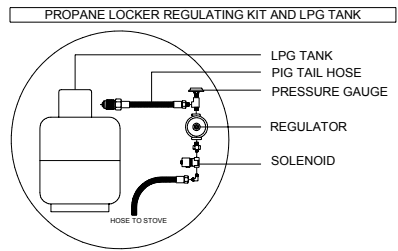

2 CABIN / 2 TOILET

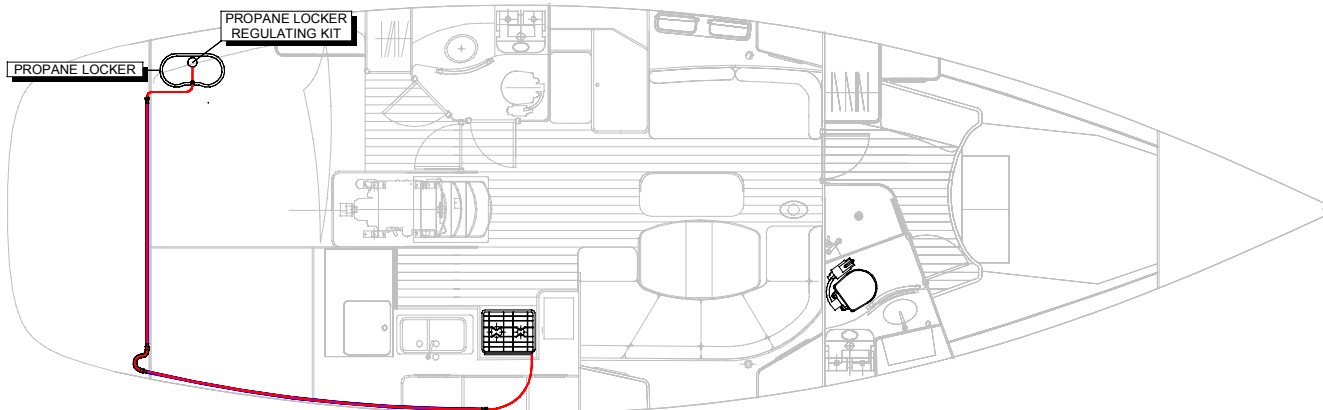

3 CABIN / 2 TOILET

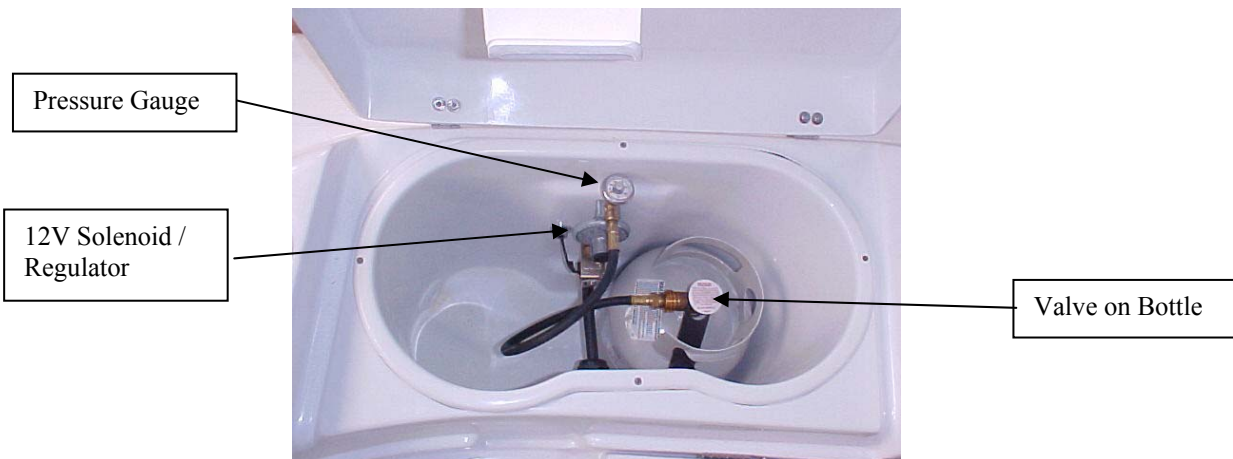
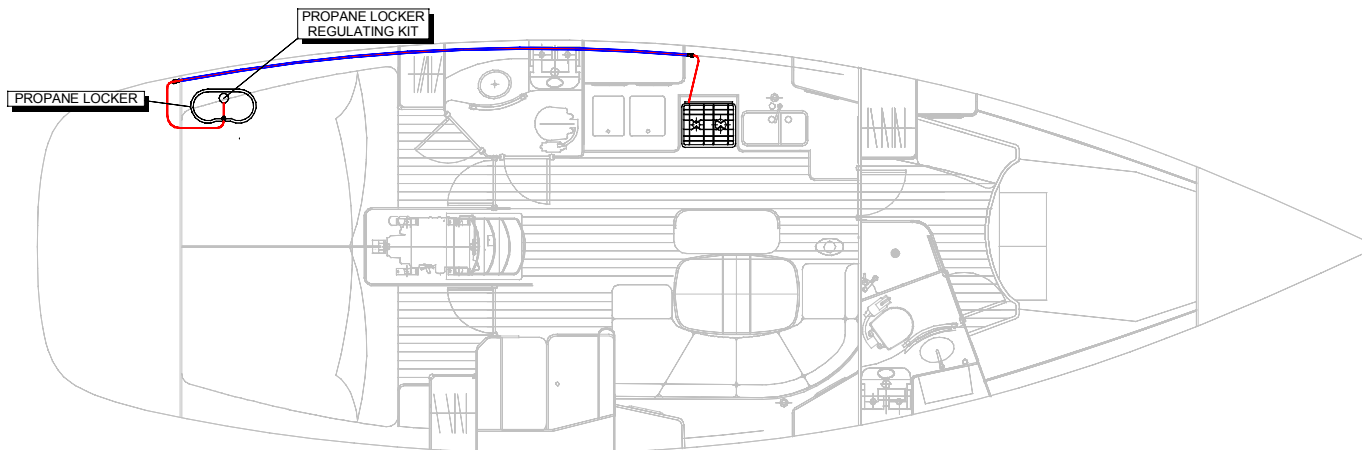

XIX) STEERING SYSTEM

Your boat is provided with an emergency tiller for use if there is a failure in the wheel steering system.

Check at least once a year that the steering cables are properly tightened and lubricated.

To use the emergency tiller, remove the cover over the rudder stock by using a winch handle; insert the tiller into the socket on the rudderstock. You may remove the steering wheels while using the tiller, to improve the tiller handle clearance.

REF	DESCRIPTION	REF	DESCRIPTION
1	Rudder	10	Cap Over Rudder Stock
2	Spacer Ring	11	Steering Cable
3	Lower Rudder Shaft Bearing	12	Idler Sheave Box
4	Rudder Tube	13	Steering Chain
5	Upper Rudder Shaft Bearing	14	Steerer
6	Retaining Ring	15	Wheel Brake
7	Quadrant	16	Steering Wheel
8	Quadrant Pin	17	Emergency Tiller
9	Rudder stop		

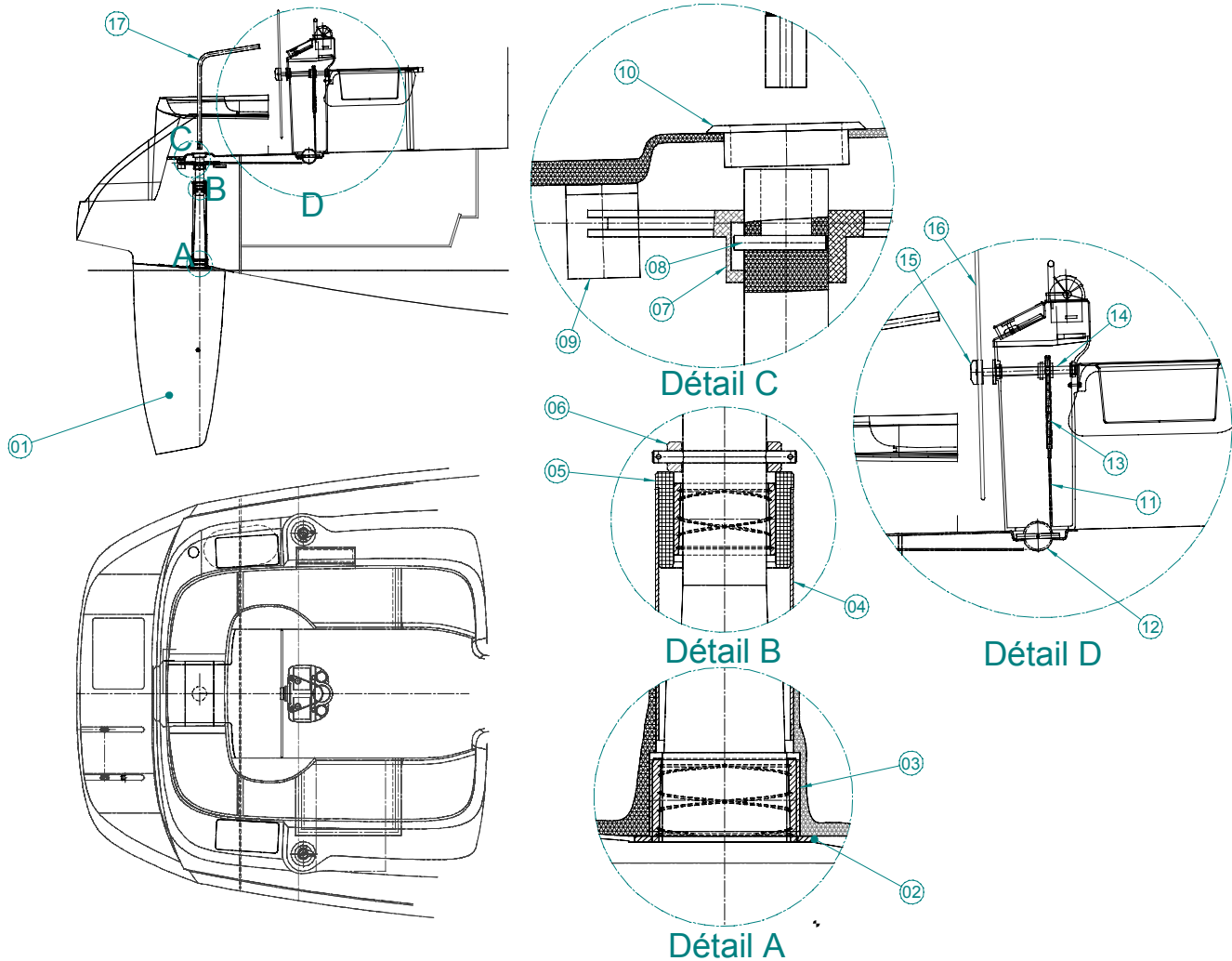

XX) ENGINE

Stop the engine; and do not smoke while you are filling up the fuel tank.

Before you start the engine, make sure that the engine compartment bilge is clean and dry. If there is the slightest presence of fuel in the engine compartment, you must not start the engine.

Fuel that is stored outside the tanks (spare cans, jerrycans) should be kept and stored in a ventilated place.

Know exactly where the fire extinguisher aperture is located so you will be able to put out a fire breaking out in the engine compartment.

ENGINE LAY OUT

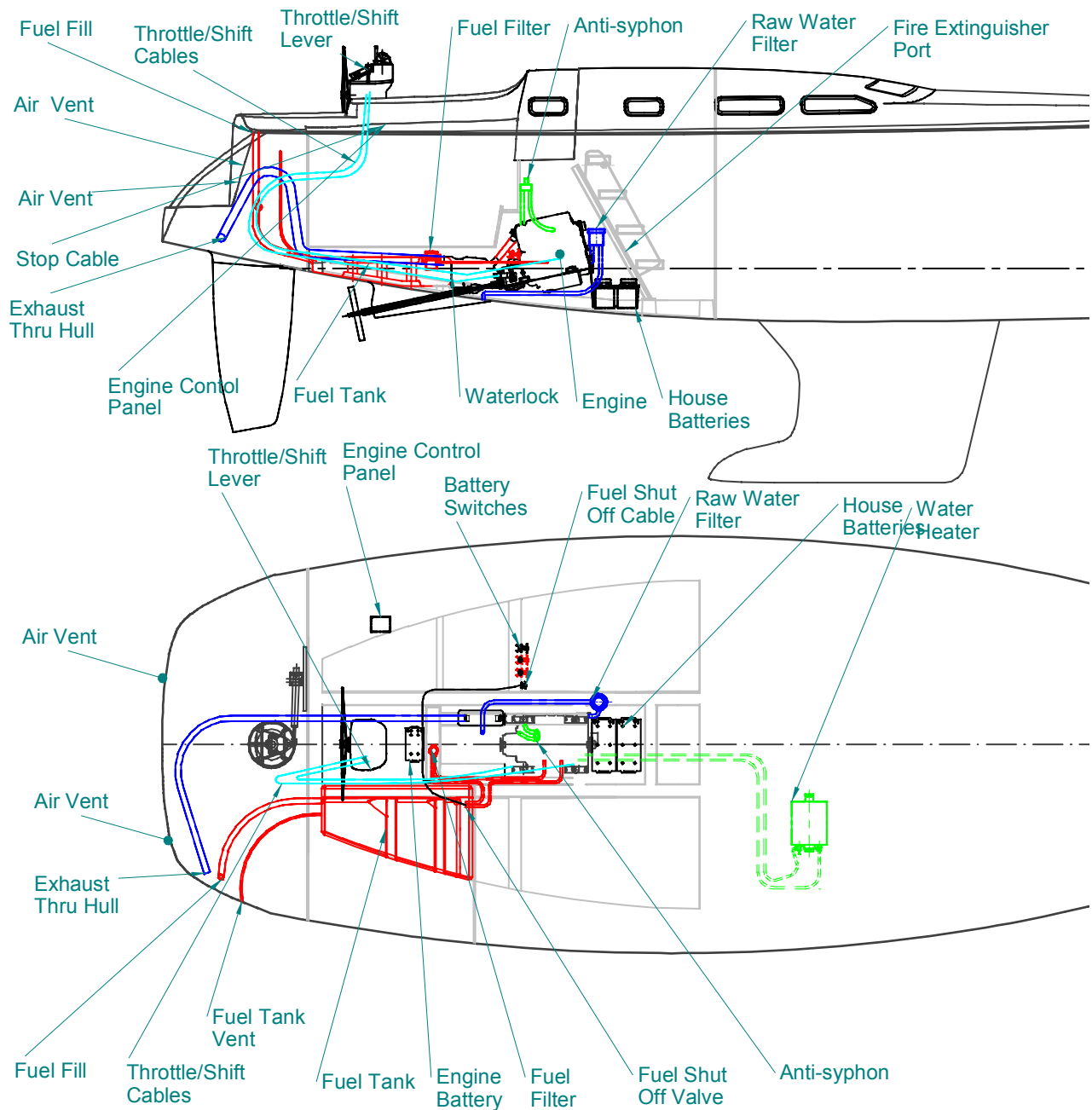

XXI) HANDLING

Contact your BENETEAU dealer for maintenance and repair of your boat. The dealer will advise properly, or will supply you with the spare parts you need or the materials that are suited to your boat.

Have your boat hauled & serviced once a year.

POSITION OF LIFTING STRAPS AND CRADLE POSITION.

NOTE: FWD POSITION DIMENSION IS FROM STANCHION
AFT POSITION IS FROM THE FWD LEG OF THE GATE

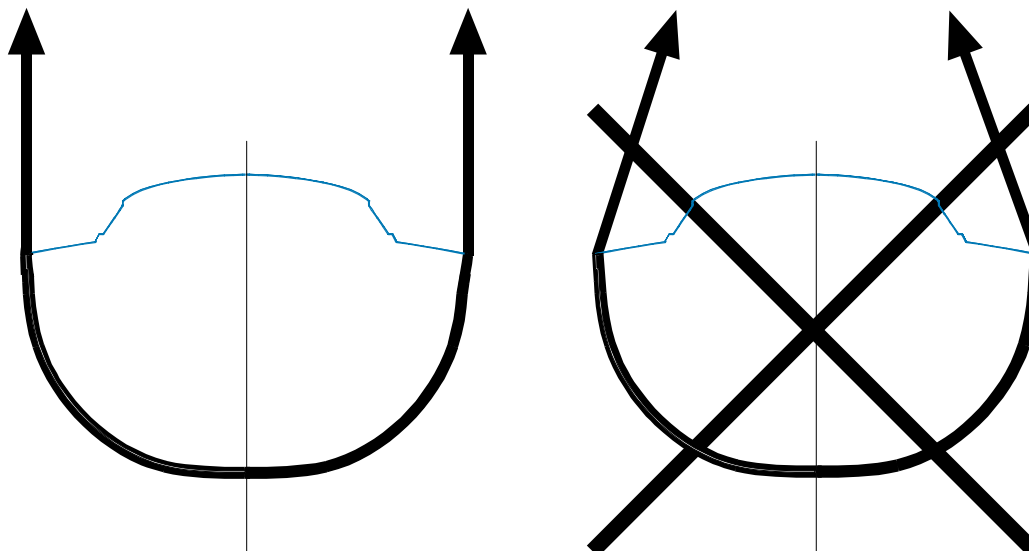
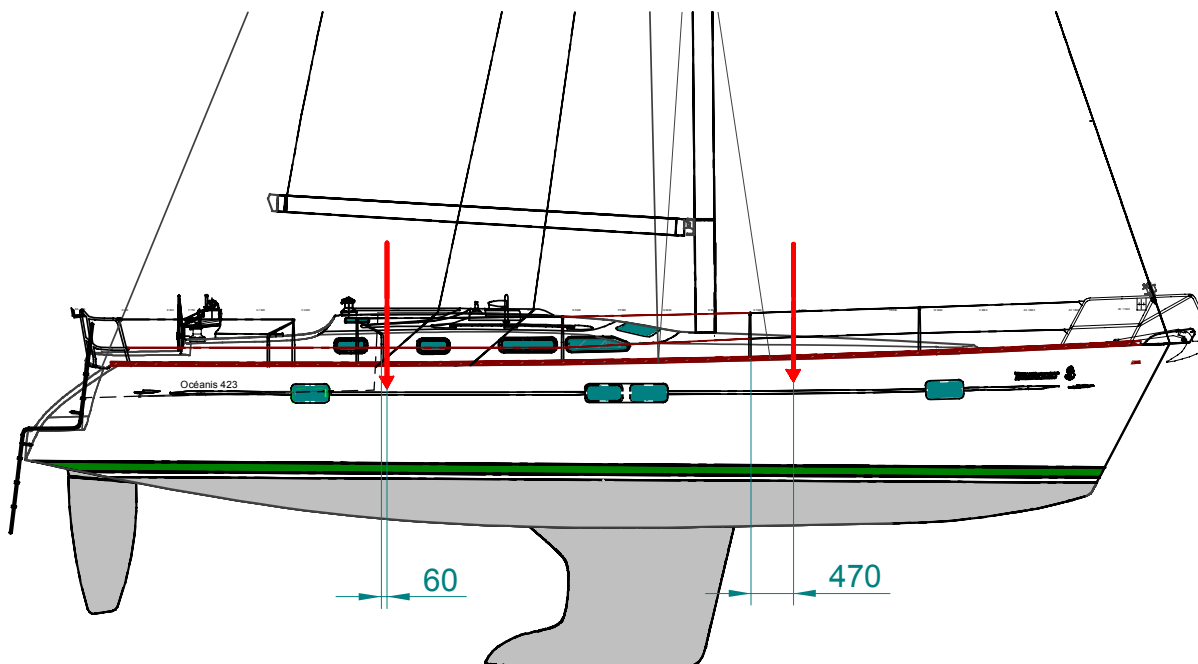

XXII) MAINTENANCE OF YOUR BOAT

Your boat represents a sizable capital investment that needs special and regular care. Safeguarding your investment and looking after your own safety should persuade you of the importance of careful and regular upkeep of your boat. The maintenance suggestions in the following sections will help you with the basics. Always refer to the original manufacturer's manual for specific guidelines on individual components.

NOTE: It is important to clean the bottom of your boat at least two or three times a year.

General Hull Maintenance

- **DO NOT SAND THE HULL WITH COARSE SANDPAPER.**
- **DO NOT USE SOLVENTS TO CLEAN HULL.**
- **DO NOT WASH WITH PRESSURE MACHINE USING WATER WARMER THAN 95 DEGREES F. (35 degrees C.).**
- **DO NOT USE PRESSURE EXCESS OF 2175 PSI (150 BAR.) WHEN USING A HIGH PRESSURE SPRAY WASH.**
- **DO NOT HOLD NOZZLE CLOSER THAN 4 INCHES (10 CM) TO SURFACE OF HULL.**
- **DO NOT MACHINE SAND.**

We believe the above points to be pertinent for all FRP boats.

GEL COAT

The gel-coat is vulnerable to any nicks and scratches it may get during maneuvering in harbor and on a mooring. The best way to avoid them is to undertake maneuvering calmly, after thinking out all the relevant factors (such as speed, current, wind, and the layout of the harbor). Always have one of the crew ready to put out a fender at the right place. When bringing in the anchor chain, back off or swing the boat round so as not to rub the chain against the hull. Hold the anchor well clear as you bring it aboard so that it does not scrape the stem: lay it on deck and lash it down at once, if only temporarily.

Never use dirty fenders.

Hose off the hull and deck as often as possible, with fresh water.

Before hosing down, remember to check that the hatch covers are closed; and it is wise not to take on diesel oil or fresh water supplies while you are hosing off the hull.

After a few years, the gel coat may be re-polished, either with a lambs wool buffer and polish, or by hand using a polish or similar product. Your yard will also be able to supply you with special cleaning products for getting rid of stubborn stains.

MINOR GEL COAT REPAIRS

To fill in a scratch or small nick, order a **Beneteau Gel coat Repair Kit** with instructions for use, from your dealer or obtain a small quantity of gel coat and catalyst.

Clean the affected area and rub it down with wet-and-dry sandpaper, then dry it off thoroughly (use a hair-dryer if necessary). Mix the components of the gel coat, and fill the scratch using a spatula avoiding any excess; cover with a sheet of cellophane. Once hardened remove cellophane and rub down with very fine wet/dry sandpaper (grade 600 or 800), and finish off by polishing the new surface.

THE DECK AND DECK FITTINGS

Using a gentle liquid detergent, scrub all nonskid areas to keep them free of dirt.

Light-alloy sections (tracks, etc.) can be cleaned in the same manner.

The tiny spots of oxidation pitting that may appear on stainless steel parts are nothing to worry about. Polishing will remove them.

From time to time, lubricate pulley blocks and sheaves, turnbuckles, tracks and travelers with light grease or a water-repellent lubricant such as WD-40 or Triflow.

After a certain time at sea, your winches will need cleaning inside. They must be cleaned out completely once a year. Follow the manufacturer's instructions carefully.

When dismantling deck fittings, have a bowl close at hand for putting the parts in, and circle the area with a rolled dishcloth, or the like, so that any screws or springs you drop do not roll overboard. Use the lubricant recommended by the manufacturer before reassembling.

Warning! Incorrect re-assembly can cause accidents. Note the order in which parts are dismantled, which will make it easier to put them together again later.

Acrylic plastic hatch covers and portholes should be rinsed off with fresh water and rubbed over with a soft cloth soaked in liquid paraffin.

THE RUDDER

Once a year, check steering gear. If necessary renew any parts (bushings, glands, etc.) that are worn. Lubricate the steering chain and cable and or gears.

Never lubricate Nylon, Ertalon or Teflon bushings, with either oil or grease, use only WD-40.

If you have wheel steering, maintenance should be in accordance with the manufacturer's recommendations.

Make regular checks on all the clamps, the condition of the quadrant, the cables or push rods, guide sheaves and the chain in the column to the wheel.

Make regular checks of the steering end stops to ensure they are adequately stopping the rotation of the rudder, this is important for direct drive push rod systems. Over rotation of the rudder could cause a steering lock up.

INTERIOR WOOD

Repairs to interior varnished surfaces are very challenging to accomplish. They should be attempted by skilled professionals.

The internal woodwork used in most of our boats is varnished. This should be regularly rinsed off with fresh water and a little liquid detergent, then polished with a chamois leather.

Should the woodwork become damaged, gently rub it down with very fine sandpaper and touch it with several coats of the varnish. Your dealer should be able to order a Beneteau touch up kit. When this is dry, rub it down with a very fine wet-and-dry sandpaper (grade 800 or 1000) and finish off with polish (or a silicone spray) or wax.

ELECTRICAL SYSTEMS

It is essential for an electrical system to have a battery in sound condition to function properly. The following are some of the things to maintain a battery in the best condition.

- Keep the battery clean and the terminal posts well greased.
- Keep the battery electrolyte checked regularly
- Keep the battery fully charged.

If you have to leave your boat unused for more than a month it is best to leave your batteries with your yard so that they can be kept charged. Keep a suitable charger onboard so you can recharge your batteries at dockside without having to turn on the engine.

If you have an inboard engine, check the condition and tension of the alternator drive belt. From time to time, spray a little WD-40 or something similar on all the connections to the control panel, terminal boxes and lamp sockets. Make sure that cable grommets are watertight; smear them with Vaseline so that they do not dry out and deteriorate.

BATTERY MAINTENANCE

Make sure that the level of the electrolyte is always at least 1/2" above the top of the plates. This level can change suddenly, due to evaporation in an overheated bilge.

WARNING! THE ELECTROLYTE IN A BATTERY IS A SOLUTION OF SULFURIC ACID. IF ANY SHOULD ENTER THE EYES, RINSE IMMEDIATELY WITH LARGE AMOUNTS OF FRESH WATER, AND SEEK MEDICAL ATTENTION. ELECTROLYTE SPILLED ON SKIN SHOULD BE RINSED WELL WITH FRESH WATER. EVEN SMALL AMOUNTS OF ELECTROLYTE SPILLED ON CLOTHING WILL DESTROY THE CLOTHING.

If the level is low, fill the battery with distilled water and nothing else. The level of acidity (i.e. the relative density of the electrolyte) should also be checked from time to time.

CAUTION! USE ONLY PURE DISTILLED WATER TO REPLENISH ELECTROLYTE LEVELS. THE WATER FROM MANY CITY WATER SUPPLY SYSTEMS IS UNSATISFACTORY FOR BATTERY USE.

Keep battery connections clean and tight. A cup full of strong baking soda solution and a toothbrush will clean corrosion from the terminals and neutralize any spilled acid (do not allow any of the solution to enter the battery cells). A coating of petroleum jelly or silicone grease on the battery terminals will inhibit corrosion.

WATER SYSTEM

Check all joints regularly for leaks. Keep the tank(s) filled. If, however, you have to leave the boat unattended for several months, disconnect the water lines, purge them, and rinse them thoroughly with vinegar and water so that they do not form foul-smelling deposits.

Important: If the electric pump continues running when all the taps are closed, switch off the power supply at once and check the water system to find and overcome the leak that is causing this.

Check the thru-hulls, seacocks, connectors and hose clamps regularly. Make sure the seacocks turn freely.

MARINE HEAD

Maintenance consists of regularly pumping the system out with fresh water and leaving the holding tank empty whenever possible.

Check the thru-hulls, seacocks, connectors and hose clamps regularly. Make sure the seacocks turn freely.

ENGINE

Whether maintenance of the power system is to be performed by the owner or delegated to a mechanic, it is the owner who must first initiate any action that is to take place. He must either perform the maintenance or decide to call someone to do the job. A working knowledge of the power system is essential in the first case, and preventive maintenance desirable in the second. The engine manual is, of course, the prime source for engine information and should be consulted, preferably before the fact. The following paragraphs are included as a supplement to cover any required maintenance procedures that are not a part of the engine manual.

We have already stressed the points that are of importance for an engine to keep working properly. It might be added that the engine compartment should be kept scrupulously clean; check for any unusual oil or fuel leaks. Inspect all the electrical connections frequently.

Drain the bowl of the fuel/water separator at regular intervals to lessen the chance of water damage to your engine's fuel system. Keep fuel tanks filled.

Inspect the engine mounts and coupling for loose bolts regularly.

Check the oil and coolant levels everyday.

Check the alternator belt for the correct tension, keep a spare belt on hand.

Check all hoses and fuel lines for leaks regularly.

NOTE: Always have a spare set of sacrificial anodes on board, and regularly check those that are already fitted for deterioration; they should be replaced when their size has been reduced by half. The time this takes will vary with the waters in which the boat is used. Water temperature, salinity, the presence of neighboring boats, the nature of the bottom and the materials in the dock will all affect the life of your boat's anodes.

Order your spare anodes thru your dealer or from Beneteau Customer Service.

CALIFORNIA

Proposition 65 Warning

Diesel engine exhaust and some of its constituents are known to the State of California to cause cancer, birth defects, and other reproductive harm.

SAILS

Check the sails regularly, as the slightest wear in the stitching or at a reinforced part can very quickly have dramatic consequences. Keep a small sail repair kit on board and a book showing how to carry out minor work yourself until you can get the job done by a professional sail maker.

Keep a special eye on points where the sails can chafe on the rigging or fittings - turnbuckles, lifelines, shrouds, spreaders, etc.

Salt water and sunshine take their toll on sails. Whenever possible, rinse the sails in fresh water and leave them stretched out (preferably on a lawn) to dry. Never dry a sail by hoisting it and letting it flog in the wind; this will very quickly cause the sail to deteriorate. Never fold and store a damp sail.

XXIII) WINTERIZING PROCEDURES

The end of the season is a good time for a complete inspection of all of the boat's systems. It is easy to take shortcuts when decommissioning your boat but proper lay-up procedures will ensure trouble free recommissioning in the spring.

The following sections are oriented towards hauling your boat for winter storage in a cold climate, but they are also a good guideline as a lay-up procedure for your Beneteau in any climate.

An improperly winterized boat will lead to costly repairs and extensive delays, we recommend winterization by a competent yard or your Beneteau Dealer. The owner must ensure that the boat is correctly winterized.

HAULING

Your Beneteau should be hauled for inspection and maintenance at least once a year; the frequency of haul-outs may vary due to your local conditions and marine growth. A good boatyard is seasoned in hauling and maneuvering boats on land, you may verify this by checking to see that the weight of the hull is resting firmly on the bottom of the keel and that even contact exists along the bottom of keel. Jack stands, or cradle uprights, are meant to balance the boat and not to support its weight.

BOTTOM

Clean the yacht's bottom of any growth as soon as the boat is hauled. It is generally preferred to wait until spring to paint the bottom. Use the following guidelines when using a pressure washer:

MAXIMUM WATER TEMPERATURE TO BE 95° F. (35° C.)

MAXIMUM PRESSURE TO BE 2175 PSI (150 BARS) AT NO CLOSER THAN 4"

CUTLASS BEARING

The shaft strut contains a rubber type cutlass bearing. At haul out, be sure the bearing slots are clear and apply silicone lubricant or castor oil to the bearing to preserve its suppleness. Replace the cutlass bearing if excessive wear is evident. Be sure to realign the engine if the bearing is replaced. Bleed the prop shaft seal after re-launching

ZINC

Replace the sacrificial zinc before re-launching the boat.

FRESHWATER SYSTEM

This system is best winterized with one of the non-toxic antifreezes available for use in boat and recreational freshwater systems. It is an easy method, which replaces fresh water with a non-toxic antifreeze mixture.

Caution! Be sure to use non-toxic antifreeze in the fresh water system.

1. Allow the water in the water heater to cool, and open the pressure release valve on top. Disconnect the hot and cold water hoses and allow the tank to drain either in a bucket or into the bilge. Connect and clamp the hot and cold water hoses together using a short length of 1/2" pipe in order to bypass the heater.
2. Mix the appropriate amounts of antifreeze and water, as directed on the label, to deliver the degree of protection desired. Put 1-1/2 to 2 gallons of the solution into each water tank.
3. Open both tank selector valves on the manifold.
4. Turn on the pump and open all fixtures until antifreeze runs through. Be sure to open the hot water selector valve in order to supply antifreeze to the hot water hoses and through the bypass loop.
5. At this point, the freshwater system should be completely protected by antifreeze against freezing to a degree indicated by the strength of the solution placed into the supply tanks.
6. New boats delivered have their freshwater systems filled with antifreeze as described above, and are protected to -30 degrees F.

HEAD

Several days before completing haul-out procedures, fresh water should be allowed to stand in the head unit to dissolve any salt accumulation in the hoses and pump. Remove all water from the head. Special lubricants for the pump's internal mechanism are available. Check with your marine hardware dealer for a recommended brand. Never put oil, gas, kerosene, or alcohol in the head or they will ruin the internal valve.

Completely pump out all waste from the holding tank and pour in a cleansing, deodorizing solution. If possible, allow this to sit in the tank overnight, then completely pump out and drain the entire system. If antifreeze is used in the system, check in the manufacturer's literature for the recommended type.

ENGINE

Winterization by a marine mechanic is highly recommended to ensure that your engine is properly protected. Consult the Engine Owner's Manual for your specific engine's guidelines for winterizing. Follow the instructions carefully to ensure the engine is adequately protected. The general procedure is to replace raw seawater with an antifreeze solution mixed to protect the engine in your local area and to check the heat exchanger side to ensure that it contains an adequate antifreeze solution as well.

1. Prior to hauling the boat, run the engine to achieve normal operating temperatures in order to open the thermostat.
2. Close the raw water intake thru hull and remove the hose from the valve hose barb.
3. Insert the intake hose in a bucket of antifreeze solution and run the engine briefly until all raw water is flushed thru the exhaust system and only the antifreeze solution is expelled from the exhaust.
4. Be sure the thru hull valve is opened after the boat is hauled.

FUEL SYSTEM

Consult your engine manual to clean any engine mounted fuel filters.

Drain any water from the bottom of the fuel/water separator.

The fuel tank should be kept full for winter storage with about 5% expansion room left at the top. Empty fuel tanks encourage the formation of condensation.

BATTERIES

Clean battery terminals and cable ends thoroughly of any corrosion with a baking soda and water solution, and apply a light protective layer of petroleum jelly.

Batteries should be fully charged before storage, and the fluid level maintained. Store batteries in a warm, dry place. Do not store batteries directly on a stone or cement floor.

SEACOCKS

Open and drain all seacocks after boat is hauled. Open all seacocks for winter storage.

BILGE

Completely pump out bilge of any water and clean out any debris present. Bilge pumps should be pumped dry and hoses disconnected, to ensure that no water is left in the system.

ICEBOX

Remove any remaining food from the icebox and wash down thoroughly with warm water and detergent solution.

Odors can be removed with a baking soda and water solution, and an open box of baking soda left in the icebox will continue to remove odors throughout storage.

Completely pump out any water from the bottom of the icebox and make sure pump is completely dry of any water.

Leave icebox lid open during storage to allow ventilation.

STOVE

Depressurize the gas system and close all valves. Clean stove thoroughly. Remove fuel tanks and clean to remove any salt accumulation from their surface. Wipe down stove and tanks with a rag while applying a light layer of WD-40 or other lightweight, protective oil.

INTERIOR

Remove as much loose gear from the boat as possible and store in a clean dry place. If cushions are left on board be sure they are dry and propped on edge to encourage ventilation.

Rinse and dry all floorboards and store them on their edge to encourage ventilation. Leave all lockers clean and open for ventilation.

COVERING THE BOAT

Cover the boat adequately during storage to prevent excessive weathering.

BE SURE THE COVER DOES NOT CHAFE BOAT.

Ventilation between the winter cover and the boat is required to avoid build up of humidity.

CAUTION! DO NOT USE BLACK POLYETHYLENE AND DO NOT SHRINK-WRAP THE BOAT BY TAPING TO THE HULL. ALWAYS ASSURE GOOD VENTILATION.

SAILS

Remove the sails, clean following the sail makers recommendations and store in a clean dry space.

MAST

The aluminum mast requires a minimum of care and maintenance. At the end of each season it should be washed with a mild detergent and water solution, followed by a complete rinsing with fresh water. Tie off all halyards and lifts, and inspect the mast completely for scratches, cracks or stress marks. Apply paint or a clear lacquer to any scratches found to prevent corrosion. Consult your dealer or a marine rigger if any cracking or stressing of the aluminum tube is found.

Check all hardware on mast carefully for signs of corrosion, and check the tightness of the fastenings. Masthead sheaves should show no signs of wear and should move freely. Lubricate if necessary.

XXIV) ENVIRONMENT

Do not pour oil overboard; use appropriate waste containers.

When you fill up the engine fuel tank, take all the precautions in order to avoid overflowing.

In the harbor, do not use the heads if they are not equipped with holding tanks.

The use of detergent contributes to the deterioration of the sea fauna and flora; choose entirely biodegradable products for your cleaning operations.

Do not throw plastic bags overboard.

You love the sea, just as we do; therefore, help us to protect it and do not pollute it.